



YAVUZ 1989 yılında Türk endüstrisine AG ve OG enerji sistemlerinde kullanılmak üzere pano üretmek üzere ticari hayatına başlamıştır. Uzun süren bu yolculuk esnasında YAVUZ küçük bir işletmeden ulusal ve uluslararası pazarda güveni ve kaliteyi simgeleyen bir marka olmuştur. Bu gün hali hazırda 20.000 m²'nin üzerinde kapalı üretim alanı, ileri teknoloji makine parkı ve 200'ün üzerinde nitelikli personel istihdamı mevcuttur.

YAVUZ markası ürettiği tüm ürünler de yenilikçi olmakla beraber kalite anlamında uluslararası standartları baz almaktadır. Bu anlamda üretimini gerçekleştirdiği tüm ürün ve ürün gruplarını, Dünya çapında bilinen ve istenen Kalite Belgelendirme kuruluşlarında akredite etmektedir.



YAVUZ markası kendi adı altında aşağıdaki ürün gruplarını üretmekte olup, tüm bu alanlarda ulusal ve uluslararası anlamda takip edilen bir marka olmayı başarmıştır.

- ALÇAK GERİLİM - ORTA GERİLİM PANOLARI
- PLASTİK ALÇAK GERİLİM PANOLARI
- POLYESTER ALÇAK GERİLİM PANOLARI
- LED AYDINLATMA ARMATÜRLERİ
- KLASİK AYDINLATMA ARMATÜRLERİ
- PVC KABLO TAŞIMA TAVALARI

YAVUZ started producing Low Voltage panel boards Since 1989. Yavuz during this long journey from a small business has become a brand that symbolizes trust and quality in national and international markets. Today, YAVUZ already has a 20,000 m² closed production area on the advanced technology machine park and employees over than 200 qualified staff.

All Products Produced by YAVUZ brand are also included some international standards in terms of quality this all products and product groups that perform the production sense is known worldwide and accredited in the Quality Certification organizations.



YAVUZ under its own brand has been producing the following product groups, in all these areas has managed to become a brand that is monitored nationally and internationally.

- LOW VOLTAGE-MEDIUM VOLTAGE PANEL BOARDS
- LOW VOLTAGE PLASTIC ENCLOSURES
- LOW VOLTAGE POLYESTER ENCLOSURES
- LED LIGHTING FIXTURES
- CLASSIC LIGHTING FIXTURES
- PVC CABLE LADDERS (TRAYS)

YAVUZ'DA 2015



YAVUZ Ulusal bir marka olmanın yanı sıra uluslararası pazardaki varlığını arttırarak dünyanın hemen hemen her bölgesinden 40'ı aşkın ülkeye ihracat atağını sürdürdü.



YAVUZ AR-GE çalışmalarına 2015 yılında da hız kesmeden devam ederek ürün koleksiyonunu geliştirmiştir. Pazarın taleplerine ve eksiklerine cevap verecek şekilde teknolojik yapısını güncellemeye devam etmiştir.



Biz 2015'de YAVUZ olarak kalitemize ve hizmet anlayışımıza artı değer katmak adına kurumsal yapımızı geliştirmeye devam ettik. Kurumsallaşırken hantallaşmaktan çok, sektörün ve müşterilerimizin taleplerini dikkate alarak özgün çözümlerle yapımızı daha dinamik bir hale getirdik.



Kurulduğumuzdan bugüne kadar yaşama değer katmayı önemsedik. 2015 yılında yine Dünyadaki tüm çevresel konuları yakından takip ederek kendimizi bu anlamda geliştirmeye ürünlerimizi ve üretim tesislerimizi doğaya zarar vermeyecek şekilde dizayn etme konusunda çalışmalarımıza devam ettik.



Yavuz Aydınlatma "Manage Your City-Şehrini Yönet" sloganı ile Akıllı Şehir Aydınlatma ve Kontrol Sistemi ile kullanıcılara bir şehrin tüm aydınlatma sistemlerini internete bağlı arayüz üzerinden kontrol etme olanağı sağlıyor. Her bir aydınlatma noktası için gerçek zamanlı durum raporlarıyla, kolay ve modern bakım ve gözetim imkanı sunan Menage Your City ile aydınlatma operatörleri sistemin her bir parçasının tüketim ve aydınlatma seviye verilerini takip edebiliyor.

Aydınlatma seviyelerini yerel ihtiyaçlara göre ayarlayabilen Menage Your City, şehirlerin hem enerji maliyetleri kısma hem de doğayı korumalarına katkı sağlıyor. Şehrin yoğun saatler dışında şehir genelindeki aydınlatma noktalarını kısma, hataları tespit etmeye ve iş akışı desteği sağlamaya olanak tanıyan sistem, işletme maliyetlerini ve enerji kullanımını belirgin oranda azaltarak enerji faturalarının düşmesine, daha az karbon emisyonuna ve daha az ışık kirliliğine yol açıyor.

Yavuz Lighting with "Manage Your City" Slogan Smart City Lighting and lighting systems of a city Control System provides users with the ability to control the interface connected to the Internet. With real-time status report for each lighting point is able to follow simple and modern facilities offer care and supervision of Manage Your City each part of the system operators with lighting and illumination level consumption data.

You can adjust the lighting levels according to local needs, and energy costs contribute to part of the city as well as nature conservation. The city's peak hours outside the city to cut the lighting points in the overall system, which allows errors to provide support and workflow to detect, operating costs and energy use significantly in the reduction of the energy bill, reducing to less carbon emissions and leads to less light pollution.



YAVUZ olarak kaliteyi hayatımızın vazgeçilmez bir parçası olarak görür ve ürünlerimizin üretiminden siz değerli müşterilerimize ulaştırdığımız ana kadar teknolojinin tüm imkanlarını kullanarak kalite anlamında evrensel tüm talepleri ve gereksinimleri yerine getirmeyi kendimize prensip edinmiş bulunmaktayız.

25 yılı aşkın süredir Türk sanayisine hizmet eden bir kuruluş olarak her zaman kalitenin adresi olmayı vazife olarak bildik. Bu anlamda Ulusal ve Uluslararası kalite belgelendirme kuruluşları tarafından tüm belgelendirme çalışmalarımızı yerine getirmekteyiz. Biz YAVUZ olarak siz değerli müşterilerimizi varlık sebebimiz olarak görüp sizi de YAVUZ'un seçkin ve ayrıcalıklı dünyasına davet etmekteyiz.

YAVUZ: The quality of the fulfillment of universal all the demands and requirements in terms of quality using all the possibilities of technology until we deliver to our esteemed customers from view, and the production of our products as an indispensable part of our lives, we have adopted the principle ourselves.

For more than 25 years as an organization that services the task of Turkish industry, we always know that the address of quality. We fulfill all our certification work by this sense of national and international quality certification bodies.

We urge you to also see it as our reason for being our valued customers YAVUZ exclusive and privileged world.



IP (INGRESS PROTECTION) KORUMA SINIFI

| 1. Rakam katı cisimlere karşı koruma derecesi | 0 Korumasız | 1 Damlayan suya karşı koruma | 2 15'ye kadar damlayan suya karşı korumalı | 3 60'ye kadar damlayan suya karşı korumalı | 4 Sıçrayan suya karşı korumalı | 5 Su Püskürtmesine karşı korumalı | 6 Şiddetli deniz dalgalarına karşı koruma | 7 Suya daldırmanın etkilerine karşı korumalı | 8 Su altında bırakmaya karşı korumalı |
|--------------------------------------------------------|----------------|------------------------------------|-----------------------------------------------------|-----------------------------------------------------|--------------------------------------|-----------------------------------------|----------------------------------------------------|-------------------------------------------------------|------------------------------------------------|
| Korumasız | 0 | IP 00 | IP 01 | IP 02 | -- | -- | -- | -- | -- |
| 50mm'den büyük katı cisimlere karşı koruma | 1 | IP 10 | IP 11 | IP 12 | IP 13 | -- | -- | -- | -- |
| 12mm'den büyük katı cisimlere karşı koruma | 2 | IP 20 | IP 21 | IP 22 | IP 23 | -- | -- | -- | -- |
| 2,5 mm'den büyük katı cisimlere karşı koruma | 3 | IP 30 | IP 31 | IP 32 | IP 33 | IP 34 | -- | -- | -- |
| 1 mm'den büyük katı cisimlere karşı koruma | 4 | IP 40 | IP 41 | IP 42 | IP 43 | IP 44 | IP 45 | IP 46 | -- |
| Toza karşı korumalı | 5 | -- | -- | -- | IP 54 | IP 55 | IP 56 | -- | -- |
| Toz geçirmez | 6 | -- | -- | -- | -- | -- | IP 65 | IP 66 | IP 67 |

LED; Light Emitting Diode (Işık saçan diyot): 1900'lü yılların başlarında geliştirilen LED ler uzun yıllar sadece elektronik sistemlerde sinyalizasyon amaçlı kullanılmıştır.

Teknolojinin hızla gelişmesi sonucu 2000 li yılların başları itibari ile aydınlatma alıcısı olarak kullanılmaya başlayan LED teknolojileri hali hazırda gelişmeye devam ederek her geçen gün daha verimli hale gelmektedir.

SMD Surface Mount Device: Üzerine herhangi bir delme işlemi gerçekleştirilmeden, devre elemanlarının dizgi yöntemiyle lehimlenmesi anlamına gelmektedir halk arasında bu tür ürünlere şerit led olarakta isim verilmektedir.

CRI - (Color Rendering Index, Renk Sunum İceriği): Renk Sunumu bir ışık kaynağının cisimlerdeki renk üretimidir. 0-100 arasında değerlendirilir. 100 en canlı rengi gösterir. 80 CRI'lık bir ışık kaynağı 60 CRI'lıktan daha canlı ışık verir.

LED AYDINLATMA / LED LIGHTING

| | | |
|-------------------------------------------------------------------------------------------------------------------------------------------|----|----|
| Eko Serisi Yol ve Cadde Armatürleri - Led Alüminyum Enjeksiyon <i>Eco Series LED Aluminium Injection Highway and Street Luminaires</i> | 10 | 11 |
| Yol ve Cadde Armatürleri - LED Alüminyum Enjeksiyon <i>LED Aluminium Injection Highway and Street Luminaires</i> | 12 | 13 |
| Projektörler - LED Alüminyum Enjeksiyon <i>LED Aluminium Injection Floodlights</i> | 14 | 15 |
| Comfort Projektörler - LED Alüminyum Enjeksiyon <i>LED Aluminium Injection Comfort Floodlights</i> | 16 | |
| Metro & Tünel - LED Aydınlatma Armatürleri <i>LED Subway & Tunnel Luminaires</i> | 17 | |
| LED Kanopi Benzinlik İstasyon Armatürleri <i>LED KNP Gas Station Luminaires</i> | 18 | |
| LED Alüminyum Yüksek Tavan Armatürleri <i>LED Aluminium High Ceiling Luminaires</i> | 19 | |
| LED Alüminyum Etanj Armatürler <i>LED Aluminium Waterproof Luminaires</i> | 20 | |
| LED Etanj - Polikarbon Cam ve Gövdeli Etanj Armatürler <i>LED Waterproof - PC Body & Covered Luminaires</i> | 21 | |
| LED Tube Etanj Armatürler <i>LED Tube Waterproof Luminaires</i> | 22 | |
| Sensörlü LED Glob <i>Motion Sensored LED Globes</i> | 23 | |
| Slim Kasa Sıva Altı Oval Armatürler <i>Slim Downlight Luminaires</i> | 24 | |
| LED Slim Panel <i>Led Slim Panel</i> | 25 | |
| Eko Seri LED Modül Sıva Altı Ofis Tipi Panel Armatürler <i>Eco Series LED Module Type Recessed Mounted Office Panel Luminaires</i> | 26 | |
| Eko Serisi LED Modül Sıva Üstü Ofis Tipi Panel Armatürler <i>Eco Series LED Module Type Surface Mounted Office Panel Luminaires</i> | 27 | |
| Elegant LED Alüminyum Sıva Altı Ofis Tipi Panel Armatürler <i>Elegant LED Aluminium Type Recessed Mounted Office Panel Luminaires</i> | 28 | |
| Elegant LED Alüminyum Sıva Üstü Ofis Tipi Panel Armatürler <i>Elegant LED Aluminium Type Surface Mounted Office Panel Luminaires</i> | 29 | |
| Wallwasher Armatürler <i>Wallwasher Luminaires</i> | 30 | |
| RGB Wallwasher Armatürler <i>RGB Wallwasher Luminaires</i> | 31 | |
| LED Lineer Armatürler <i>LED Lineer Luminaires</i> | 32 | |
| LED Park Bahçe Armatürleri <i>LED Garden Luminaires</i> | 33 | |

KLASİK AYDINLATMA / CLASSIC LIGHTING

| | | |
|--------------------------------------------------------------------------------------------------------------------|----|----|
| Elektronik Balastlı T8 Parabolik Ofis Armatürleri <i>Office Luminaires T8 Parabolic With Electronic Ballast</i> | 36 | |
| T5 Parabolik Ofis Armatürleri <i>T5 Parabolic Office Luminaires</i> | 37 | |
| T5 Yüksek Tavan Armatürler <i>T5 Fluorescent High Ceiling Luminaires</i> | 38 | 39 |
| Polikarbon Gövde - Polikarbon Cam Etanj Armatürler <i>Pc Bodied & Pc Glass Waterproof Luminaires</i> | 40 | |
| T5 Polikarbon Gövde - Polikarbon Cam Etanj Armatürler <i>T5 Pc Bodied & Pc Glass Waterproof Luminaires</i> | 41 | |
| Polimer Enjeksiyon Yol ve Cadde Armatürleri <i>Polymer Injection Street Luminaires</i> | 42 | 43 |
| Alüminyum Enjeksiyon Yol ve Cadde Armatürleri <i>Aluminium Injection Highway and Street Luminaires</i> | 44 | 45 |
| Polyester Gövde Projektörler <i>Polyester Bodied Floodlight</i> | 46 | |
| Alüminyum Döküm Stad Projektörü <i>Die Cast Aluminium Floodlight</i> | 47 | |

SOLAR AYDINLATMA / SOLAR LIGHTING

Solar Aydınlatma Sistemleri - Uygulama Seçenekleri
Solar Lighting Systems - Application Options

50 51 52 53

PVC KABLO TAŞIMA TAVALARI / PVC CABLE CARRIAGE TRAYS

Kablo Tavası ve Tava Kapakları
Cable Trays and Covers

58

Dönüş Elemanları

Return Components - Accessories

59 60

Redüksiyon - Ek - İç - Dış Bükümler

Reduction Connection Components - Accessories

61

Taşıma Parçaları

Carrier Parts

62

Taşıma Parçaları - Vida ve Somunlar

Carrier Parts - Screw and Nuts

63

POLYESTER PANO / POLYESTER ENCLOSURES

Taban Saclı Polyester Panolar
Polyester Enclosures

66

Polyester Sayaç Panoları

Polyester Meter Enclosures

67

ABS - PC PANOLAR / ABS - POLYCARBONATE ENCLOSURES

Opak Kapaklı Taban Saclı Panolar
Coloured Cover Enclosures

70 71

Şeffaf Kapaklı Taban Saclı Panolar
Transparent Cover Boxes With Inner Plate

72 73

Sıva Üstü W Otomat Kutuları
Surface Mounted MCB Boxes

74

Sıva Altı W Otomat Kutuları
Recessed Mounted MCB Boxes

75

Sıva Üstü Sayaç ve Dağıtım Panoları
Surface Mounted Meter and Distribution Boxes

76 77 78

Dahili ve Harici Dağıtım Panoları
Indoor & Outdoor Use Distribution Boxes

79 80

Dahili ve Harici Duvar Tipi Şantiye Panoları
Indoor & Outdoor Type Workshop Boxes

81

Harici Tip Ayaklı Şantiye Panoları
Outdoor Type Workshop Boxes

82 83

Kombinasyon Kutuları
Combination Boxes

84 85

Telefon Dağıtım Panoları
Phone Distribution Boxes

86 87

Buat Kutuları
Junction Boxes

88

COMFORT SERİSİ LED PROJKTÖR



“ÇÖZÜM ARAYANLAR İÇİN”





LED AYDINLATMA
LED LIGHTING

2016
COLLECTION

EKO SERİSİ YOL VE CADDE ARMATÜRLERİ - LED ALÜMİNYUM ENJ.

Eco Series LED Aluminium Injection Highway and Street Luminaires



GÖVDE & CAM

Body & Glass

SÜRÜCÜ

Driver Type

KART

PCB

ÇALIŞMA VOLTAJİ

Operating Voltage

ÇALIŞMA SICAKLIĞI

Operating Heat

VERİMLİLİK

Efficiency

KALİTE STANDARDI

Quality Standart

Alüminyum Enj. Gövde & Temperli Cam

Aluminium Inj. Body & Tempered Glass

PFC - Sabit Akım - Kısa Devre ve Aşırı Yük Korumalı

PFC - Constant Current - Short Circuit Overload Protected

Alüminyum

Aluminium

220 V - 240 V AC 50 - 60 Hz

-30° / +70 °C

>%92

TS 8700 EN 60598-2-3



LED renk (K) ve mercek açıları kullanım koşullarına göre opsiyoneldir.

LED color (K) and lens angle it is optional according to the terms of use.

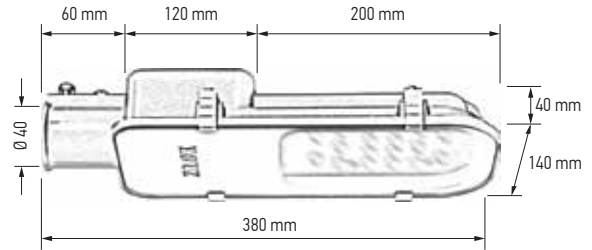
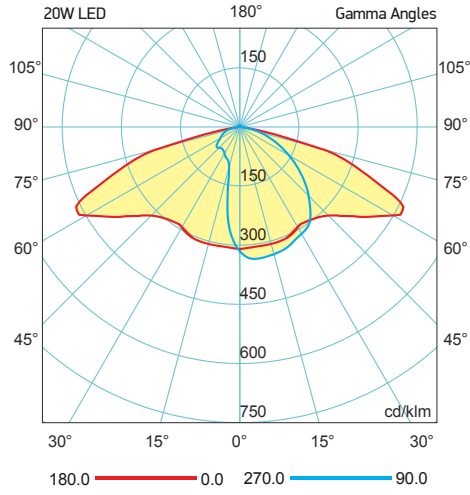

| ÜRÜN KODU Product Code | GÜÇ Power | IŞIK AKISI Lumen | RENK SICAKLIĞI Kelvin | AĞIRLIK Weight (kg) | ÖLÇÜLER Dimensions (mm) | KONSOL ÇAPI Ø Console Diameter Ø | KOLİ AD. Pcs / Ctn | FİYAT Prices (\$) |
|---------------------------|--------------|---------------------|--------------------------|------------------------|----------------------------|-------------------------------------|-----------------------|----------------------|
| VL548020-1 | 20W | 2.500 | 6.000 K | 1,60 | 140 x 380 x 40 | Ø 40 | 1 | 90,00 |
| VL548030-1 | 40W | 5.000 | 6.000 K | 1,60 | 140 x 380 x 40 | Ø 40 | 1 | 99,00 |

EKO SERİSİ YOL VE CADDE ARMATÜRLERİ - LED ALÜMİNYUM ENJ.

Eco Series LED Aluminium Injection Highway and Street Luminaires



GÖVDE & CAM

Body & Glass

SÜRÜCÜ

Driver Type

KART

PCB

ÇALIŞMA VOLTAJİ

Operating Voltage

ÇALIŞMA SICAKLIĞI

Operating Heat

VERİMLİLİK

Efficiency

KALİTE STANDARDI

Quality Standart

Alüminyum Enj. Gövde & Temperli Cam

Aluminium Inj. Body & Tempered Glass

PFC - Sabit Akım - Kısa Devre ve Aşırı Yük Korumalı

PFC - Constant Current - Short Circuit Overload Protected

Alüminyum

Aluminium

220 V - 240 V AC 50 - 60 Hz

-30° / +70 °C

>%92

TS 8700 EN 60598-2-3



LED renk (K) ve mercek açıları kullanım koşullarına göre opsiyoneldir.

LED color (K) and lens angle it is optional according to the terms of use.

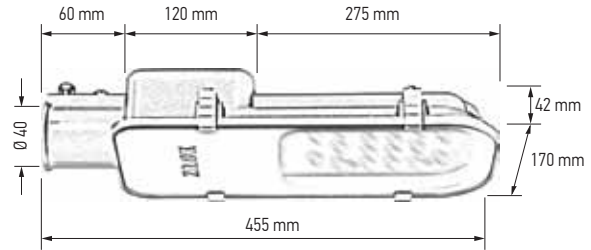
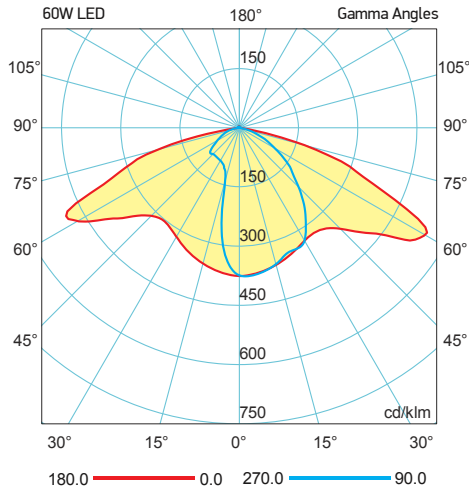

| ÜRÜN KODU Product Code | GÜÇ Power | IŞIK AKISI Lumen | RENK SICAKLIĞI Kelvin | AĞIRLIK Weight (kg) | ÖLÇÜLER Dimensions (mm) | KONSOL ÇAPI Ø Console Diameter Ø | KOLİ AD. Pcs / Ctn | FİYAT Prices (\$) |
|---------------------------|--------------|---------------------|--------------------------|------------------------|----------------------------|-------------------------------------|-----------------------|----------------------|
| VL548060-1 | 60W | 7.500 | 6.000 K | 2,70 | 170 x 455 x 42 | Ø 40 | 1 | 232,00 |
| VL548100-1 | 100W | 12.500 | 6.000 K | 2,70 | 170 x 455 x 42 | Ø 40 | 1 | 295,00 |

YOL VE CADDE ARMATÜRLERİ - LED ALÜMİNYUM ENJ.

LED Aluminium Injection Highway and Street Luminaires



GÖVDE & CAM

Body & Glass

SÜRÜCÜ

Driver Type

KART

PCB

ÇALIŞMA VOLTAJ

Operating Voltage

ÇALIŞMA SICAKLIĞI

Operating Heat

VERİMLİLİK

Efficiency

KALİTE STANDARTI

Quality Standart

Alüminyum Enj. Gövde & Temperli Cam

Aluminium Inj. Body & Tempered Glass

PFC - Sabit Akım - Kısa Devre ve Aşırı Yük Korumalı

PFC - Constant Current - Short Circuit Overload Protected

Alüminyum

Aluminium

220 V - 240 V AC 50 - 60 Hz

-30° / +70 °C

>%92

TS 8700 EN 60598-2-3



IP65

60.000
saat ömür

2 yıl
garantili

RoHS

LED renk (K) ve mercekle açılımları kullanım koşullarına göre opsiyoneldir.

LED color (K) and lens angle it is optional according to the terms of use.

HAVALANDIRMA SİBOBU / VENTILATION PLUGS

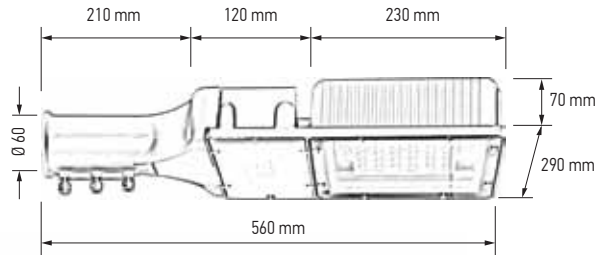
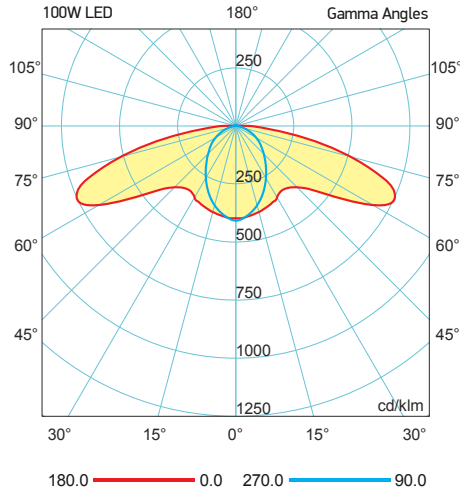

ENEC veya IP67 Belgeli Proje ürünlerimiz için lütfen fiyat sorunuz.

Please ask price for your documentary project for, ENEC and IP67 Certificated.

| ÜRÜN KODU Product Code | GÜÇ Power | IŞIK AKISI Lumen | RENK SICAKLIĞI Kelvin | AĞIRLIK Weight (kg) | ÖLÇÜLER Dimensions (mm) | KONSOL ÇAPI Ø Console Diameter Ø | KOLİ AD. Pcs / Ctn | FİYAT Prices (\$) |
|---------------------------|--------------|---------------------|--------------------------|------------------------|----------------------------|-------------------------------------|-----------------------|----------------------|
| VL548045 | 45W | 5.600 | 6.000 K | 6,95 | 290 x 560 x 70 | Ø 60 | 1 | 250,00 |
| VL548060 | 60W | 7.500 | 6.000 K | 6,95 | 290 x 560 x 70 | Ø 60 | 1 | 275,00 |
| VL548090 | 100W | 11.250 | 6.000 K | 6,95 | 290 x 560 x 70 | Ø 60 | 1 | 346,00 |
| VL548120 | 120W | 15.000 | 6.000 K | 6,95 | 290 x 560 x 70 | Ø 60 | 1 | 382,00 |

YOL VE CADDE ARMATÜRLERİ - LED ALÜMİNYUM ENJ.

LED Aluminium Injection Highway and Street Luminaires



HAVALANDIRMA SİBOBU / VENTILATION PLUGS

GÖVDE & CAM

Body & Glass

SÜRÜCÜ

Driver Type

KART

PCB

ÇALIŞMA VOLTAJI

Operating Voltage

ÇALIŞMA SICAKLIĞI

Operating Heat

VERİMLİLİK

Efficiency

KALİTE STANDARDI

Quality Standart

Alüminyum Enj. Gövde & Temperli Cam

Aluminium Inj. Body & Tempered Glass

PFC - Sabit Akım - Kısa Devre ve Aşırı Yük Korumalı

PFC - Constant Current - Short Circuit Overload Protected

Alüminyum

Aluminium

220 V - 240 V AC 50 - 60 Hz

-30° / +70 °C

>%92

TS 8700 EN 60598-2-3



LED renk (K) ve mercek açıları kullanım koşullarına göre opsiyoneldir.

LED color (K) and lens angle it is optional according to the terms of use.

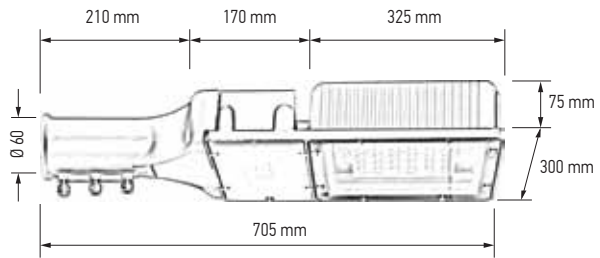
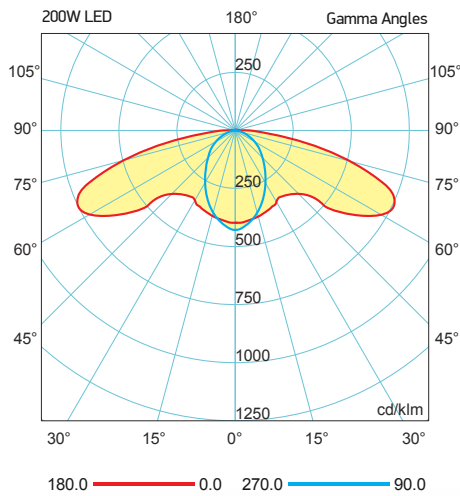

ENEC veya IP67 Belgeli Proje ürünlerimiz için lütfen fiyat sorunuz.

Please ask price for your documentary project for, ENEC and IP67 Certificated.

| ÜRÜN KODU Product Code | GÜÇ Power | IŞIK AKISI Lumen | RENK SICAKLIĞI Kelvin | AĞIRLIK Weight (kg) | ÖLÇÜLER Dimensions (mm) | KONSOL ÇAPI Ø Console Diameter Ø | KOLİ AD. Pcs / Ctn | FİYAT Prices (\$) |
|---------------------------|--------------|---------------------|--------------------------|------------------------|----------------------------|-------------------------------------|-----------------------|----------------------|
| VL548150 | 150W | 18.750 | 6.000 K | 10,00 | 300 x 705 x 75 | Ø 60 | 1 | 480,00 |
| VL548200 | 200W | 25.000 | 6.000 K | 10,00 | 300 x 705 x 75 | Ø 60 | 1 | 590,00 |
| VL548250 | 250W | 31.250 | 6.000 K | 10,00 | 300 x 705 x 75 | Ø 60 | 1 | 650,00 |
| VL548300 | 300W | 37.500 | 6.000 K | 10,00 | 300 x 705 x 75 | Ø 60 | 1 | 810,00 |
| VL548400 | 400W | 50.000 | 6.000 K | 10,00 | 300 x 705 x 75 | Ø 60 | 1 | 920,00 |

PROJEKTÖRLER - LED ALÜMİNYUM ENJEKSİYON

LED Aluminium Injection Floodlights



HAVALANDIRMA SİBOBU / VENTILATION PLUGS

GÖVDE & CAM

Body & Glass

SÜRÜCÜ

Driver Type

KART

PCB

ÇALIŞMA VOLTAJİ

Operating Voltage

ÇALIŞMA SICAKLIĞI

Operating Heat

VERİMLİLİK

Efficiency

KALİTE STANDARDI

Quality Standart

Alüminyum Enj. Gövde & Temperli Cam

Aluminium Inj. Body & Tempered Glass

PFC - Sabit Akım - Kısa Devre ve Aşırı Yük Korumalı

PFC - Constant Current - Short Circuit Overload Protected

Alüminyum

Aluminium

220 V - 240 V AC 50 - 60 Hz

-30° / +70 °C

>%92

TS 8702 EN 60598-2-5



IP65

60.000
saat ömür

2 yıl
garantili

RoHS

LED renk (K) ve mercekle açılımları kullanım koşullarına göre opsiyoneldir.

LED color (K) and lens angle it is optional according to the terms of use.

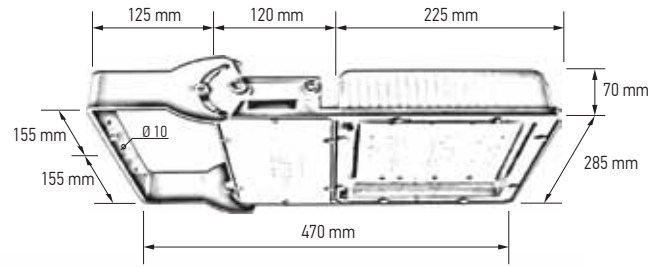
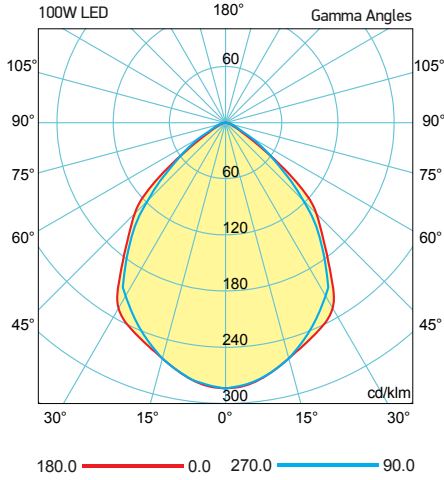

ENEC veya IP67 Belgeli Proje ürünlerimiz için lütfen fiyat sorunuz.

Please ask price for your documentary project for, ENEC and IP67 Certificated.

| ÜRÜN KODU Product Code | GÜÇ Power | İŞIK AKISI Lumen | RENK SICAKLIĞI Kelvin | AĞIRLIK Weight (kg) | ÖLÇÜLER Dimensions (mm) | KOLİ AD. Pcs / Ctn | FİYAT Prices (\$) |
|---------------------------|--------------|---------------------|--------------------------|------------------------|----------------------------|-----------------------|----------------------|
| VL508045 | 45W | 5.600 | 6.000 K | 6,95 | 285 x 470 x 70 | 1 | 250,00 |
| VL508060 | 60W | 7.500 | 6.000 K | 6,95 | 285 x 470 x 70 | 1 | 275,00 |
| VL508090 | 100W | 11.250 | 6.000 K | 6,95 | 285 x 470 x 70 | 1 | 346,00 |
| VL508120 | 120W | 15.000 | 6.000 K | 6,95 | 285 x 470 x 70 | 1 | 382,00 |

PROJEKTÖRLER - LED ALÜMİNYUM ENJEKSİYON

LED Aluminium Injection Floodlights



Opsiyonel / Optional

GÖVDE & CAM

Body & Glass

SÜRÜCÜ

Driver Type

KART

PCB

ÇALIŞMA VOLTAJİ

Operating Voltage

ÇALIŞMA SICAKLIĞI

Operating Heat

VERİMLİLİK

Efficiency

KALİTE STANDARDI

Quality Standart

Alüminyum Enj. Gövde & Temperli Cam

Aluminium Inj. Body & Tempered Glass

PFC - Sabit Akım - Kısa Devre ve Aşırı Yük Korumalı

PFC - Constant Current - Short Circuit Overload Protected

Alüminyum

Aluminium

220 V - 240 V AC 50 - 60 Hz

-30° / +70 °C

>%92

TS 8702 EN 60598-2-5



IP65

60.000
saat ömür

2 yıl
garantili

RoHS

LED renk (K) ve merceğ açılı kullanımı koşullarına göre opsiyoneldir.

LED color (K) and lens angle it is optional according to the terms of use.

HAVALANDIRMA SİBOBU / VENTILATION PLUGS

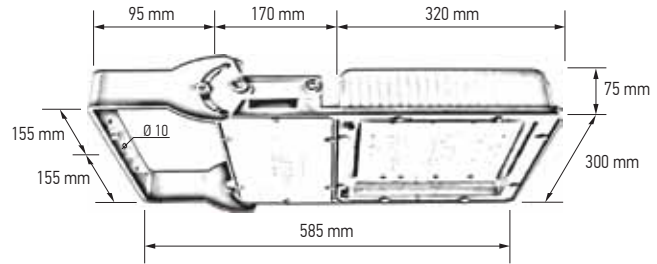
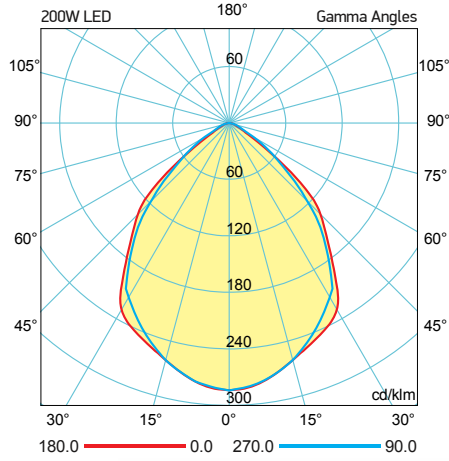

ENEC veya IP67 Belgeli Proje ürünlerimiz için lütfen fiyat sorunuz.

Please ask price for your documentary project for, ENEC and IP67 Certificated.

| ÜRÜN KODU Product Code | GÜÇ Power | IŞIK AKISI Lumen | RENK SICAKLIĞI Kelvin | AĞIRLIK Weight (kg) | ÖLÇÜLER Dimensions (mm) | KOLİ AD. Pcs / Ctn | FİYAT Prices (\$) |
|---------------------------|--------------|---------------------|--------------------------|------------------------|----------------------------|-----------------------|----------------------|
| VL 508150 | 150W | 18.500 | 6.000 K | 10,00 | 300 x 585 x 75 | 1 | 480,00 |
| VL508200 | 200W | 25.000 | 6.000 K | 10,00 | 300 x 585 x 75 | 1 | 590,00 |
| VL508250 | 250W | 31.250 | 6.000 K | 10,00 | 300 x 585 x 75 | 1 | 650,00 |
| VL508300 | 300W | 37.500 | 6.000 K | 10,00 | 300 x 585 x 75 | 1 | 810,00 |
| VL508400 | 400W | 50.000 | 6.000 K | 10,00 | 300 x 585 x 75 | 1 | 920,00 |

COMFORT PROJKTÖRLER - LED ALÜMİNYUM ENJEKSİYON

LED Aluminium Injection Floodlights



GÖVDE & CAM

Body & Glass

SÜRÜCÜ

Driver Type

KART

PCB

ÇALIŞMA VOLTAJİ

Operating Voltage

ÇALIŞMA SICAKLIĞI

Operating Heat

VERİMLİLİK

Efficiency

KALİTE STANDARTI

Quality Standart

Alüminyum Enj. Gövde & Temperli Cam

Aluminium Inj. Body & Tempered Glass

PFC - Sabit Akım - Kısa Devre ve Aşırı Yük Korumalı

PFC - Constant Current - Short Circuit Overload Protected

Alüminyum

Aluminium

220 V - 240 V AC 50 - 60 Hz

-30° / +70 °C

>%92

TS 8702 EN 60598-2-5



LED renk (K) ve mercek açıları kullanım koşullarına göre opsiyoneldir.

LED color (K) and lens angle it is optional according to the terms of use.

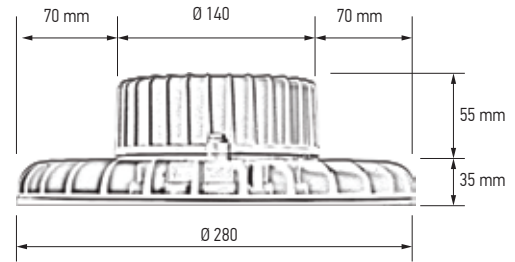
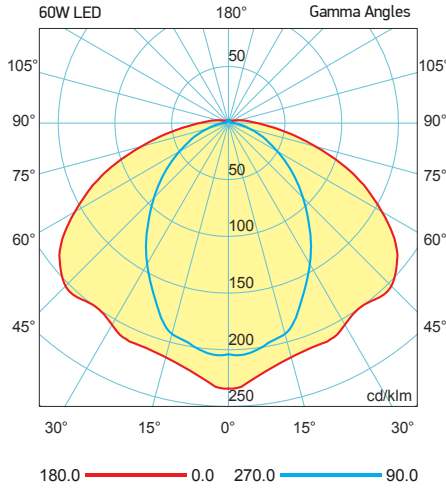

| ÜRÜN KODU Product Code | GÜÇ Power | İŞIK AKISI Lumen | RENK SICAKLIĞI Kelvin | AĞIRLIK Weight (kg) | ÖLÇÜLER Dimensions (mm) | KOLİ AD. Pcs / Ctn | FİYAT Prices (\$) |
|---------------------------|--------------|---------------------|--------------------------|------------------------|----------------------------|-----------------------|----------------------|
| VL509030 | 30W | 3.750 | 6.000 K | 2,25 | Ø280 x 90 | 1 | 200,00 |
| VL509060 | 60W | 7.500 | 6.000 K | 2,25 | Ø280 x 90 | 1 | 250,00 |
| VL509090 | 90W | 11.250 | 6.000 K | 2,25 | Ø280 x 90 | 1 | 300,00 |

METRO & TÜNEL - LED AYDINLATMA ARMATÜRLERİ

LED Subway & Tunnel Luminaires



GÖVDE & CAM

Body & Glass

SÜRÜCÜ

Driver Type

KART

PCB

ÇALIŞMA VOLTAJİ

Operating Voltage

ÇALIŞMA SICAKLIĞI

Operating Heat

VERİMLİLİK

Efficiency

KALİTE STANDARTI

Quality Standart

Alüminyum Enj. Gövde & Temperli Cam

Aluminium Inj. Body & Tempered Glass

PFC - Sabit Akım - Kısa Devre ve Aşırı Yük Korumalı

PFC - Constant Current - Short Circuit Overload Protected

Alüminyum

Aluminium

220 V - 240 V AC 50 - 60 Hz

-30° / +70 °C

>%92

TS 8702 EN 60598-2-5



LED renk (K) ve merceği açıları kullanım koşullarına göre opsiyoneldir.

LED color (K) and lens angle it is optional according to the terms of use.

HAVALANDIRMA SİBOBU / VENTILATION PLUGS

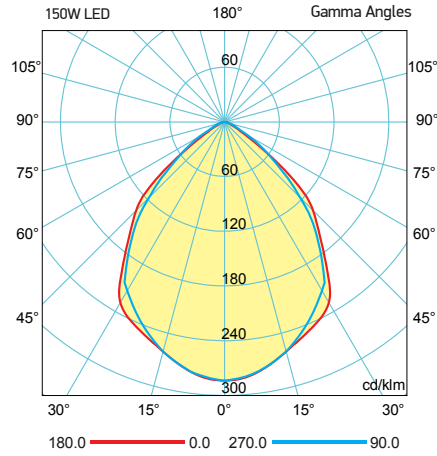
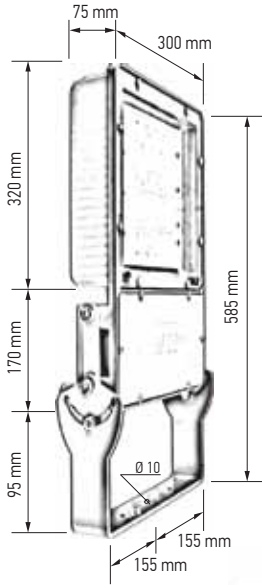

ENEC veya IP67 Belgesi Proje ürünlerimiz için lütfen fiyat sorunuz.

Please ask price for your documentary project for, ENEC and IP67 Certificated.

| ÜRÜN KODU Product Code | GÜÇ Power | IŞIK AKISI Lumen | RENK SICAKLIĞI Kelvin | AĞIRLIK Weight (kg) | ÖLÇÜLER Dimensions (mm) | KONSOL BOYU Console (mm) | KOLİ AD. Pcs / Ctn | FİYAT Prices (\$) |
|---------------------------|--------------|---------------------|--------------------------|------------------------|----------------------------|-----------------------------|-----------------------|----------------------|
| VL428090 | 100W | 11.250 | 6.000 K | 6,95 | 285 x 470 x 70 | 345 x 40 | 1 | 346,00 |
| VL428120 | 120W | 15.000 | 6.000 K | 6,95 | 285 x 470 x 70 | 345 x 40 | 1 | 382,00 |
| VL428150 | 150W | 18.750 | 6.000 K | 10,00 | 300 x 585 x 75 | 490 x 40 | 1 | 480,00 |
| VL428200 | 200W | 25.000 | 6.000 K | 10,00 | 300 x 585 x 75 | 490 x 40 | 1 | 590,00 |

LED KANOPİ BENZİNLİK İSTASYON ARMATÜRLERİ

LED KNP Gas Station Luminaires

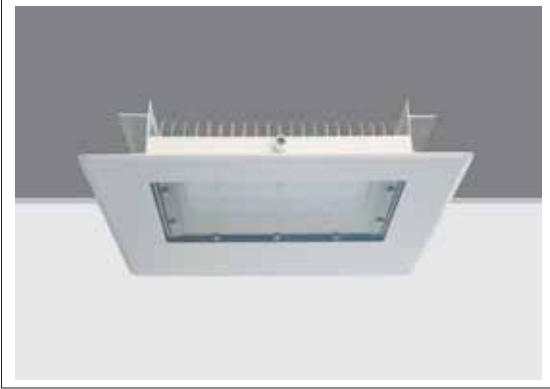

GÖVDE & CAM

Body & Glass

SÜRÜCÜ

Driver Type

KART

PCB

ÇALIŞMA VOLTAJİ

Operating Voltage

ÇALIŞMA SICAKLIĞI

Operating Heat

VERİMLİLİK

Efficiency

KALİTE STANDARDI

Quality Standart

Alüminyum Gövde & Temperli Cam

Aluminium Body & Tempered Glass

PFC - Sabit Akım - Kısa Devre ve Aşırı Yük Korumalı

PFC - Constant Current - Short Circuit Overload Protected

Alüminyum

Aluminium

220 V - 240 V AC 50 - 60 Hz

-30° / +70 °C

>%92

TS 8702 EN 60598-2-2



HAVALANDIRMA SİBOBU / VENTILATION PLUGS

LED renk (K) ve mercek açıları kullanım koşullarına göre opsiyoneldir.

LED color (K) and lens angle it is optional according to the terms of use.

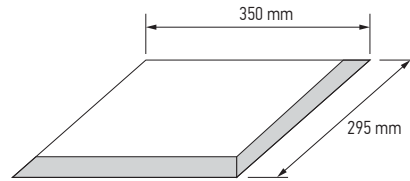
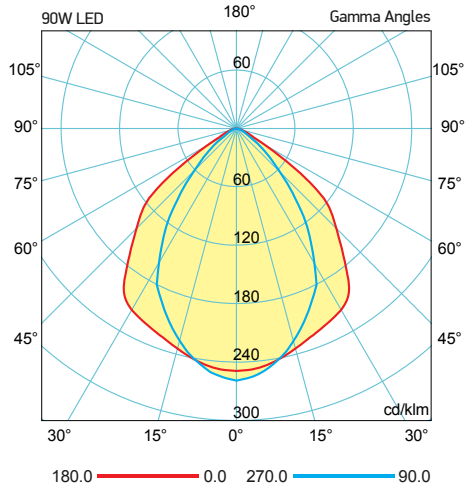

ENEC veya IP67 Belgeli Proje ürünlerimiz için lütfen fiyat sorunuz.

Please ask price for your documentary project for, ENEC and IP67 Certificated.

| ÜRÜN KODU Product Code | GÜÇ Power | IŞIK AKISI Lumen | RENK SICAKLIĞI Kelvin | AĞIRLIK Weight (kg) | ÖLÇÜLER Dimensions (mm) | KOLİ AD. Pcs / Ctn | FİYAT Prices (\$) |
|---------------------------|--------------|---------------------|--------------------------|------------------------|----------------------------|-----------------------|----------------------|
| VL600060 | 60W | 7.500 | 6.000 K | 8,50 | 425 x 425 x 110 | 1 | 320,00 |
| VL600090 | 90W | 11.250 | 6.000 K | 8,50 | 425 x 425 x 110 | 1 | 350,00 |

LED ALÜMİNYUM YÜKSEK TAVAN ARMATÜRLERİ

LED Aluminium High Ceiling Luminaires



GÖVDE & CAM

Body & Glass

SÜRÜCÜ

Driver Type

KART

PCB

ÇALIŞMA VOLTAJİ

Operating Voltage

ÇALIŞMA SICAKLIĞI

Operating Heat

VERİMLİLİK

Efficiency

KALİTE STANDARDI

Quality Standart

Alüminyum Eloksal Gövde & Polikarbon Cam

Aluminium Anodized Body & Polycarbonate Glass

PFC - Sabit Akım - Kısa Devre ve Aşırı Yük Korumalı

PFC - Constant Current - Short Circuit Overload Protected

Alüminyum

Aluminium

220 V - 240 V AC 50 - 60 Hz

-30° / +70 °C

>%92

TS 8698 EN 60598-2-1



LED renk (K) ve mercek açıları kullanım koşullarına göre opsiyoneldir.

LED color (K) and lens angle it is optional according to the terms of use.

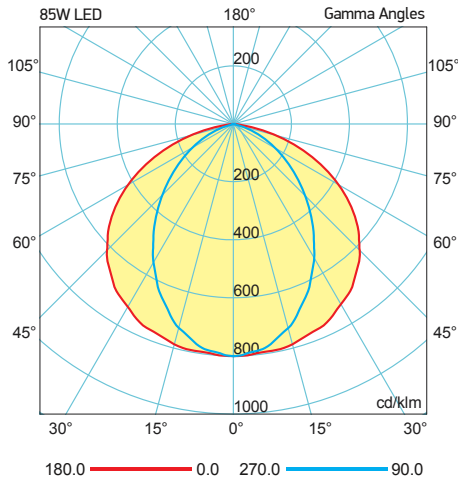

Acil kitli uygulamalarınız için lütfen fiyat sorunuz.

Please ask price with emergency kit applications.

| ÜRÜN KODU Product Code | GÜÇ Power | IŞIK AKISI Lumen | RENK SICAKLIĞI Kelvin | AĞIRLIK Weight (kg) | ÖLÇÜLER Dimensions (mm) | KOLİ AD. Pcs / Ctn | FİYAT Prices (\$) |
|---------------------------|--------------|---------------------|--------------------------|------------------------|----------------------------|-----------------------|----------------------|
| VL528085 | 85W | 10.625 | 6.000 K | 3,50 | 192 x 1245 x 50 | 1 | 210,00 |
| VL528105 | 105W | 13.125 | 6.000 K | 4,60 | 192 x 1540 x 50 | 1 | 250,00 |
| VL528125 | 125W | 15.625 | 6.000 K | 5,60 | 290 x 1245 x 50 | 1 | 300,00 |
| VL528160 | 160W | 20.000 | 6.000 K | 6,40 | 290 x 1540 x 50 | 1 | 330,00 |

LED ALÜMİNYUM ETANJ ARMATÜRLER

LED Aluminium Waterproof Luminaires



GÖVDE & CAM

Body & Glass

SÜRÜCÜ

Driver Type

KART

PCB

ÇALIŞMA VOLTAJİ

Operating Voltage

ÇALIŞMA SICAKLIĞI

Operating Heat

VERİMLİLİK

Efficiency

KALİTE STANDARTI

Quality Standart

Alüminyum Ekstrüzyon Beyaz Gövde & Şeffaf / Opal Cam

Aluminium Extrusion White Body & Transparent / Opal Glass

PFC - Sabit Akım - Kısa Devre ve Aşırı Yük Korumalı

PFC - Constant Current - Short Circuit Overload Protected

CEM 1

CEM 1

220 V - 240 V AC 50 - 60 Hz

-30° / +70 °C

>%92

TS 8698 EN 60598-2-1



LED renk (K) ve mercek açıları kullanım koşullarına göre opsiyoneldir.

LED color (K) and lens angle it is optional according to the terms of use.

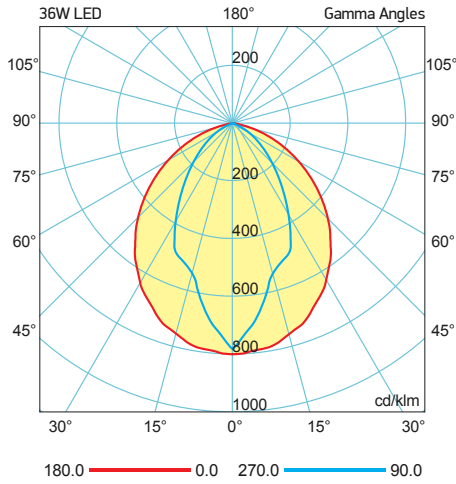

Acil kitli uygulamalarınız için lütfen fiyat sorunuz.

Please ask price with emergency kit applications.

| ÜRÜN KODU Product Code | GÜÇ Power | IŞIK AKISI Lumen | RENK SICAKLIĞI Kelvin | AĞIRLIK Weight (kg) | ÖLÇÜLER Dimensions (mm) | KOLİ AD. Pcs / Ctn | FİYAT Prices (\$) |
|---------------------------|--------------|---------------------|--------------------------|------------------------|----------------------------|-----------------------|----------------------|
| VL568018 | 18W | 2.800 | 6.000 K | 2,70 | 125 x 1210 x 70 | 6 | 125,00 |
| VL568036 | 36W | 5.600 | 6.000 K | 2,70 | 125 x 1210 x 70 | 6 | 160,00 |

LED ETANJ - POLİKARBON CAM VE GÖVDELİ ETANJ ARMATÜRLER

LED Waterproof - PC Body & Covered Luminaires



GÖVDE & CAM

Body & Glass

SÜRÜCÜ

Driver Type

KART

PCB

ÇALIŞMA VOLTAJI

Operating Voltage

ÇALIŞMA SICAKLIĞI

Operating Heat

VERİMLİLİK

Efficiency

KALİTE STANDARTI

Quality Standart

Polikarbon Gövde & Polikarbon Cam

Polycarbonate Body & Polycarbonate Glass

PFC - Sabit Akım - Kısa Devre ve Aşırı Yük Korumalı

PFC - Constant Current - Short Circuit Overload Protected

Alüminyum

Aluminium

220 V - 240 V AC 50 - 60 Hz

-30° / +70 °C

>%92

TS 8698 EN 60598-2-1



IP65

60.000
saat ömür

2 yıl
garantili

RoHS

LED renk (K) ve merceğ açılırları kullanım koşullarına göre opsiyoneldir.

LED color (K) and lens angle it is optional according to the terms of use.

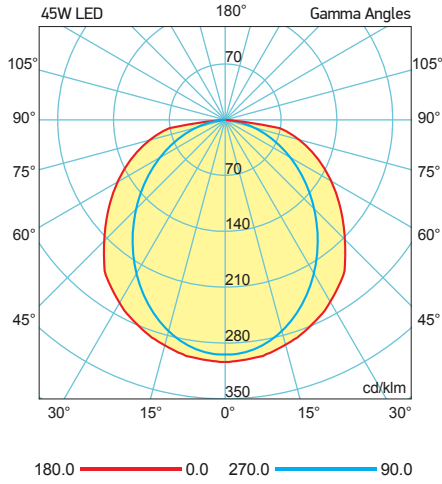

Acil kitli uygulamalarınız için lütfen fiyat sorunuz.

Please ask price with emergency kit applications.

| ÜRÜN KODU Product Code | GÜÇ Power | IŞIK AKISI Lumen | RENK SICAKLIĞI Kelvin | AĞIRLIK Weight (kg) | ÖLÇÜLER Dimensions (mm) | KOLİ AD. Pcs / Ctn | FİYAT Prices (\$) |
|---------------------------|--------------|---------------------|--------------------------|------------------------|----------------------------|-----------------------|----------------------|
| VL569030 | 30W | 3.800 | 6.000 K | 0,70 | 600 x 58 x 67 | 1 | 50,00 |
| VL569045 | 45W | 7,200 | 6.000 K | 1,30 | 1500 x 58 x 67 | 1 | 70,00 |
| VL569060 | 60W | 11,500 | 6.000 K | 1,40 | 1200 x 80 x 67 | 1 | 110,0 |

LED TUBE ETANJ ARMATÜRLER

LED Tube Waterproof Luminaires



GÖVDE & CAM

Body & Glass

REFLEKTÖR

Reflector

ÇALIŞMA VOLTAJİ

Operating Voltage

ÇALIŞMA SICAKLIĞI

Operating Heat

VERİMLİLİK

Efficiency

KALİTE STANDARDI

Quality Standart

Polikarbon Gövde & Polikarbon Cam
Polycarbonate Body & Polycarbonate Glass

0.40 mm Sac Elektrostatik Toz Boya
0.40 mm Electrostatic Power Coated Sheet

220 V - 240 V AC 50 - 60 Hz

-30° / +70 °C

>92

TS 8698 EN 60598-2-1

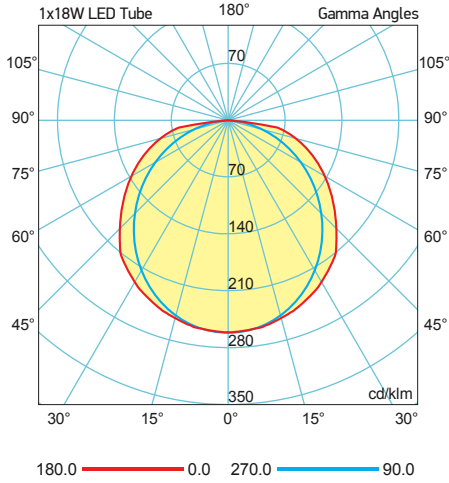

| ÜRÜN KODU Product Code | GÜÇ Power | İŞIK AKISI Lumen | RENK SICAKLIĞI Kelvin | AĞIRLIK Weight (kg) | ÖLÇÜLER Dimensions (mm) | KOLİ AD. Pcs / Ctn | FİYAT Prices (\$) |
|---------------------------|--------------|---------------------|--------------------------|------------------------|----------------------------|-----------------------|----------------------|
| VL361109 | 1 x 9 W | 900 | 4.000 - 6.500 K | 0,68 | 675 x 80 x 85 | 1 | 23,00 |
| VL361209 | 2 x 9 W | 1.800 | 4.000 - 6.500 K | 0,95 | 675 x 120 x 85 | 1 | 35,00 |
| VL361118 | 1 x 18 W | 1.600 | 4.000 - 6.500 K | 1,25 | 1250 x 80 x 85 | 1 | 32,00 |
| VL361218 | 2 x 18 W | 3.200 | 4.000 - 6.500 K | 1,90 | 1250 x 120 x 85 | 1 | 46,00 |
| VL361124 | 1 x 24 W | 2.400 | 4.000 - 6.500 K | 1,48 | 1550 x 80 x 85 | 1 | 64,00 |
| VL361224 | 2 x 24 W | 4.800 | 4.000 - 6.500 K | 2,12 | 1550x 120 x 85 | 1 | 105,00 |

Fiyatlarımıza ampul dahildir. / Our prices are including lamp.

SENSÖRLÜ LED GLOB

Motion Sensored LED Globes



GÖVDE

Body

CAM

Glass

KART

PCB

ÇALIŞMA VOLTAJI

Operating Voltage

ÇALIŞMA SICAKLIĞI

Operating Heat

ALGILAMA MESAFESİ

Detection Sensor

YANMA SÜRESİ

Time Delay

Polikarbon

PC

Polikarbon

PC

Aluminyum

Aluminium

190 V - 240 V AC

-20 °C / +50 °C

3 - 8 m

55 s - 300 s



LED renk (K) ve mercek açılımları kullanım koşullarına göre opsiyoneldir.

LED color (K) and lens angle it is optional according to the terms of use.

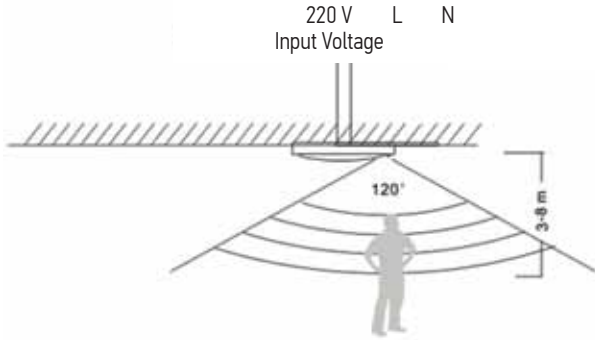

| ÜRÜN KODU Product Code | GÜÇ Power | AÇIKLAMA Description | IŞIK AKISI Lumen | RENK SICAKLIĞI Kelvin | AĞIRLIK Weight (kg) | ÖLÇÜLER Dimensions (mm) | KOLİ AD. Pcs / Ctn | FİYAT Prices (\$) |
|---------------------------|--------------|----------------------------------|---------------------|--------------------------|------------------------|----------------------------|-----------------------|----------------------|
| VL910015 | 15 W | - | 1.425 | 6.000 K | 0,90 | 290 x 290 x 120 | 5 | 35,00 |
| VL910015-ACİL | 15 W + ACİL | Acil Durum Kiti Emergency Kit | 1.425 | 6.000 K | 1,10 | 290 x 290 x 120 | 5 | 60,00 |

SLIM KASA SIVA ALTI OVAL ARMATÜRLER

Slim Downlight Luminaires



GÖVDE & CAM

Body & Glass

GÖVDE RENGİ

Body Color

SÜRÜCÜ

Driver Type

ÇALIŞMA VOLTAJİ

Operating Voltage

ÇALIŞMA SICAKLIĞI

Operating Heat

VERİMLİLİK

Efficiency

KALİTE STANDARDI

Quality Standart

Elektrostatik Toz Boyalı Alüminyum & Opal Cam
Electrostatic Powder Coated Aluminium & Opaque Glass

Beyaz

White

PFC - Sabit Akım - Kısa Devre ve Aşırı Yük Korumalı
PFC - Constant Current - Short Circuit Overload Protected

90 V - 264 V AC

-30° / +70 °C

>%92



IP40

60.000
saat ömür

2 yıl
garantili

RoHS

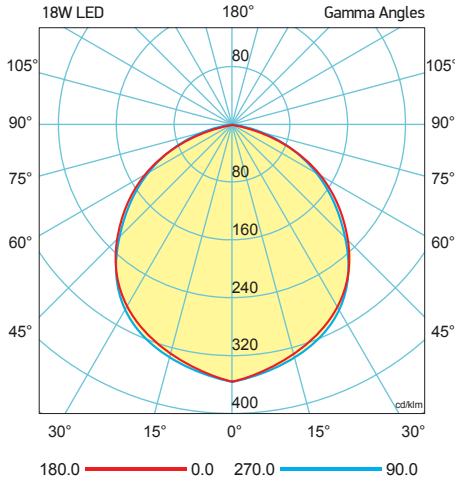

| ÜRÜN KODU Product Code | GÜÇ Power | IŞIK AKISI Lumen | RENK SICAKLIĞI Kelvin | AĞIRLIK Weight (kg) | ÖLÇÜLER Dimensions (mm) | KOLİ AD. Pcs / Ctn | FİYAT Prices (\$) |
|---------------------------|--------------|---------------------|--------------------------|------------------------|----------------------------|-----------------------|----------------------|
| VL490006 | 6W | 420 | 4.000 - 6.000 K | 0,20 | Ø120 x Ø105 x 24 | 24 | 6,00 |
| VL4900012 | 12W | 840 | 4.000 - 6.000 K | 0,35 | Ø170 x Ø155 x 24 | 24 | 9,00 |
| VL4900018 | 18W | 1.400 | 4.000 - 6.000 K | 0,50 | Ø220 x Ø205 x 24 | 24 | 11,00 |

LED SLIM PANEL

LED Slim Panel



GÖVDE & CAM

Body & Glass

GÖVDE RENGİ

Body Color

SÜRÜCÜ

Driver Type

KART

PCB

ÇALIŞMA VOLTAJİ

Operating Voltage

ÇALIŞMA SICAKLIĞI

Operating Heat

VERİMLİLİK

Efficiency

KALİTE STANDARTI

Quality Standart

Elektrostatik Toz Boyalı Alüminyum & Opal Cam
Electrostatic Powder Coated Aluminium & Opaque Glass

Beyaz

White

PFC - Sabit Akım - Kısa Devre ve Aşırı Yük Korumalı
PFC - Constant Current - Short Circuit Overload Protected

Alüminyum

Aluminium

220 V - 240 V AC 50 - 60 Hz

-30° / +70 °C

>%92

CE



IP42

60.000
saat ömür

2 yıl
garantili

RoHS

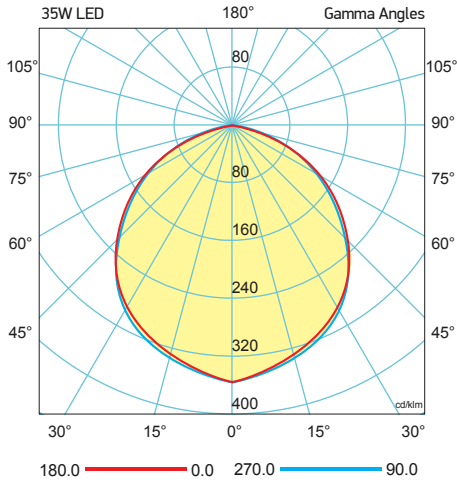

Acil kitli uygulamalarınız için lütfen fiyat sorunuz.
Please ask price with emergency kit applications.

| ÜRÜN KODU Product Code | GÜÇ Power | IŞIK AKISI Lumen | RENK SICAKLIĞI Kelvin | AĞIRLIK Weight (kg) | ÖLÇÜLER Dimensions (mm) | KOLİ AD. Pcs / Ctn | FİYAT Prices (\$) |
|---------------------------|--------------|---------------------|--------------------------|------------------------|----------------------------|-----------------------|----------------------|
| VL489035 | 35W | 3.000 | 3.500 - 6.000 K | 2,20 | 595 x 595 x 0,90 | 6 | 70,00 |

EKO SERİ LED MODÜL SIVA ALTI OFİS TİPİ PANEL ARMATÜRLER

Eco Series LED Module Type Recessed Mounted Office Panel Luminaires



GÖVDE & CAM

Body & Glass

0.60 mm. DKP Sac Gövde & Akrilik ve Polikarbon Cam
0.60 mm. Mild Steel Body & Acrylic and Polycarbonate Glass

PCB KART

PCB Card

CEM 1
CEM 1

SÜRÜCÜ

Driver Type

PFC - Sabit Akım - Kısa Devre ve Aşırı Yük Korumalı
PFC - Constant Current - Short Circuit Overload Protected

ÇALIŞMA VOLTAJİ

Operating Voltage

220 V - 240 V AC 50 - 60 Hz

ÇALIŞMA SICAKLIĞI

Operating Heat

-30° / +70 °C

VERİMLİLİK

Efficiency

>%92

KALİTE STANDARDI

Quality Standart

TS 8699 EN 60598-2-2



IP42

60.000
saat ömür

2 yıl
garantili

RoHS

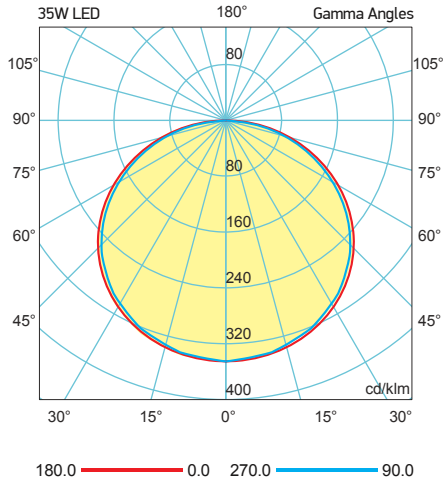

Acil kitli uygulamalarınız için lütfen fiyat sorunuz.
Please ask price with emergency kit applications.

| ÜRÜN KODU Product Code | GÜÇ Power | IŞIK AKISI Lumen | RENK SICAKLIĞI Kelvin | AĞIRLIK Weight (kg) | ÖLÇÜLER Dimensions (mm) | KOLİ AD. Pcs / Ctn | FİYAT Prices (\$) |
|---------------------------|--------------|---------------------|--------------------------|------------------------|----------------------------|-----------------------|----------------------|
| VL467035 | 35W | 3.000 | 6.000 K | 2,30 | 595 x 595 x 70 | 2 | 82,00 |
| VL467045 | 45W | 4.000 | 6.000 K | 2,30 | 595 x 595 x 70 | 2 | 95,00 |

EKO SERİ LED MODÜL SIVA ÜSTÜ OFİS TİPİ PANEL ARMATÜRLER

Eco Series LED Module Type Surface Mounted Office Panel Luminaires



GÖVDE & CAM

Body & Glass

0.60 mm. DKP Sac Gövde & Akrilik ve Polikarbon Cam
0.60 mm. Mild Steel Body & Acrylic and Polycarbonate Glass

PCB KART

PCB Card

CEM 1
CEM 1

SÜRÜCÜ

Driver Type

PFC - Sabit Akım - Kısa Devre ve Aşırı Yük Korumalı
PFC - Constant Current - Short Circuit Overload Protected

ÇALIŞMA VOLTAJİ

Operating Voltage

220 V - 240 V AC 50 - 60 Hz

ÇALIŞMA SICAKLIĞI

Operating Heat

-30° / +70 °C

VERİMLİLİK

Efficiency

>%92

KALİTE STANDARTI

Quality Standart

TS 8699 EN 60598-2-2



IP42

60.000
saat ömür

2 yıl
garantili

RoHS

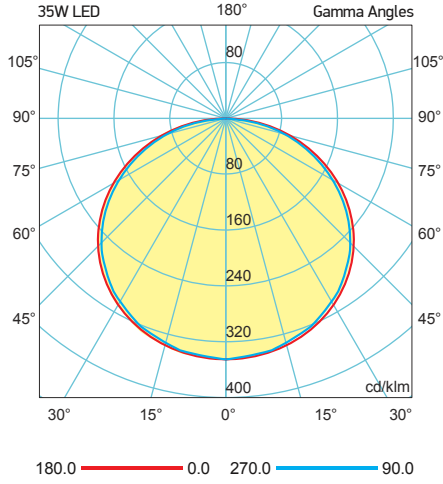

Acil kitli uygulamalarınız için lütfen fiyat sorunuz.
Please ask price with emergency kit applications.

| ÜRÜN KODU Product Code | GÜÇ Power | IŞIK AKISI Lumen | RENK SICAKLIĞI Kelvin | AĞIRLIK Weight (kg) | ÖLÇÜLER Dimensions (mm) | KOLİ AD. Pcs / Ctn | FİYAT Prices (\$) |
|---------------------------|--------------|---------------------|--------------------------|------------------------|----------------------------|-----------------------|----------------------|
| VL467135 | 35W | 3.000 | 6.000 K | 2,30 | 598 x 598 x 70 | 2 | 82,00 |
| VL467145 | 45W | 4.000 | 6.000 K | 2,30 | 598 x 598 x 70 | 2 | 95,00 |

ELEGANT LED ALÜMİNYUM SIVA ALTI OFİS TİPİ PANEL ARMATÜRLER

Elegant LED Aluminium Type Recessed Mounted Office Panel Luminaires



GÖVDE & CAM

Body & Glass

Alüminyum Gövde & Akrilik ve Polikarbon
Cam & 0.80 mm DKP Sac
Aluminium Body & Acrylic and Polycarbonate Glass &
0.80 mm Mild Steel

PCB KART

PCB Card

CEM 1
CEM 1

SÜRÜCÜ

Driver Type

PFC - Sabit Akım - Kısa Devre ve Aşırı Yük Korumalı
PFC - Constant Current - Short Circuit Overload Protected

ÇALIŞMA VOLTAJI

Operating Voltage

220 V - 240 V AC 50 - 60 Hz

ÇALIŞMA SICAKLIĞI

Operating Heat

-30° / +70 °C

VERİMLİLİK

Efficiency

>92

KALİTE STANDARDI

Quality Standart

TS 8699 EN 60598-2-2

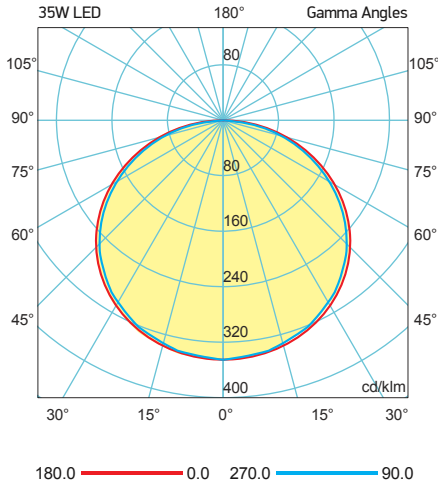

Acil kitli uygulamalarınız için lütfen fiyat sorunuz.
Please ask price with emergency kit applications.

| ÜRÜN KODU Product Code | GÜÇ Power | IŞIK AKISI Lumen | RENK SICAKLIĞI Kelvin | AĞIRLIK Weight (kg) | ÖLÇÜLER Dimensions (mm) | KOLİ AD. Pcs / Ctn | FİYAT Prices (\$) |
|---------------------------|--------------|---------------------|--------------------------|------------------------|----------------------------|-----------------------|----------------------|
| VL488035 | 35W | 3.800 | 6.000 K | 4,50 | 595 x 595 x 41 | 1 | 185,00 |
| VL488045 | 45W | 4.500 | 6.000 K | 4,50 | 595 x 595 x 41 | 1 | 210,00 |

ELEGANT LED ALÜMİNYUM SIVA ÜSTÜ OFİS TİPİ PANEL ARMATÜRLER

Elegant LED Aluminium Type Surface Mounted Office Panel Luminaires



GÖVDE & CAM

Body & Glass

Alüminyum Gövde & Akrilik ve Polikarbon
Cam & 0.80 mm DKP Sac
Aluminium Body & Acrylic and Polycarbonate Glass &
0.80 mm Mild Steel

PCB KART

PCB Card

CEM 1
CEM 1

SÜRÜCÜ

Driver Type

PFC - Sabit Akım - Kısa Devre ve Aşırı Yük Korumalı
PFC - Constant Current - Short Circuit Overload Protected

ÇALIŞMA VOLTAJI

Operating Voltage

220 V - 240 V AC 50 - 60 Hz

ÇALIŞMA SICAKLIĞI

Operating Heat

-30 °C / +70 °C

VERİMLİLİK

Efficiency

>%92

KALİTE STANDARTI

Quality Standart

TS 8699 EN 60598-2-2

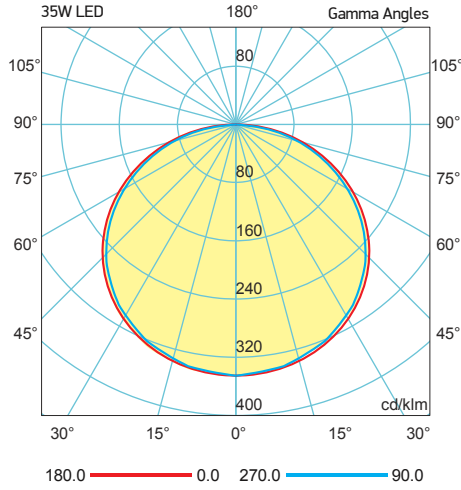

Acil kitli uygulamalarınız için lütfen fiyat sorunuz.
Please ask price with emergency kit applications.

| ÜRÜN KODU Product Code | GÜÇ Power | IŞIK AKISI Lumen | RENK SICAKLIĞI Kelvin | AĞIRLIK Weight (kg) | ÖLÇÜLER Dimensions (mm) | KOLİ AD. Pcs / Ctn | FİYAT Prices (\$) |
|---------------------------|--------------|---------------------|--------------------------|------------------------|----------------------------|-----------------------|----------------------|
| VL468035 | 35W | 3.800 | 6.000 K | 4,50 | 595 x 595 x 41 | 1 | 185,00 |
| VL468045 | 45W | 4.500 | 6.000 K | 4,50 | 595 x 595 x 41 | 1 | 210,00 |

WALLWASHER ARMATÜRLER

Wallwasher Luminaires



GÖVDE & CAM

Body & Glass

SÜRÜCÜ

Driver Type

KART

PCB

IŞIK RENGİ

Light Color

ÇALIŞMA VOLTAJİ

Operating Voltage

ÇALIŞMA SICAKLIĞI

Operating Heat

VERİMLİLİK

Efficiency

KALİTE STANDARDI

Quality Standart

Alüminyum Eloksal

Aluminium Anodized

PFC - Sabit Akım - Kısa Devre ve Aşırı Yük Korumalı

PFC - Constant Current - Short Circuit Overload Protected

Alüminyum

Aluminium

Gün Işığı-Soğuk Beyaz-Mavi-Kırmızı-Yeşil-Amber

Daylight - Cool White - Blue - Red - Green - Amber

220 V - 240 V AC 50 - 60 Hz

-30° / +70 °C

>%92

TS 8702 EN 60598-2-1



LED renk (K) ve merceğ açılış açılarını kullanım koşullarına göre opsiyoneldir.

LED color (K) and lens angle it is optional according to the terms of use.



| ÜRÜN KODU Product Code | GÜÇ Power | IŞIK AKISI Lumen | RENK SICAKLIĞI Weight (kg) | ÖLÇÜLER Dimensions (mm) | KOLİ AD. Pcs / Ctn | FİYAT Prices (\$) |
|---------------------------|--------------|---------------------|-------------------------------|----------------------------|-----------------------|----------------------|
| VL448009 | 9W | 980 | 0,85 | 250 x 50 x 65 | 1 | 50,00 |
| VL448018 | 18W | 1.960 | 1,17 | 500 x 50 x 65 | 1 | 76,00 |
| VL448036 | 36W | 3.890 | 2,15 | 1000 x 50 x 65 | 1 | 130,00 |
| VL448045 | 45W | 4.860 | 2,19 | 1200 x 50 x 65 | 1 | 160,00 |

RGB WALLWASHER ARMATÜRLER

RGB Wallwasher Luminaires



GÖVDE & CAM

Body & Glass

SÜRÜCÜ

Driver Type

KART

PCB

ÇALIŞMA VOLTAJI

Operating Voltage

ÇALIŞMA SICAKLIĞI

Operating Heat

VERİMLİLİK

Efficiency

KALİTE STANDARTI

Quality Standart

Alüminyum Eloksal

Aluminium Anodized

PFC - Sabit Akım - Kısa Devre ve Aşırı Yük Korumalı

PFC - Constant Current - Short Circuit Overload Protected

Alüminyum

Aluminium

220 V - 240 V AC 50 - 60 Hz

-30° / +70 °C

>%92

TS 8702 EN 60598-2-1



LED renk (K) ve mercek açıları kullanım koşullarına göre opsiyoneldir.

LED color (K) and lens angle it is optional according to the terms of use.



| ÜRÜN KODU Product Code | GÜÇ Power | AĞIRLIK Weight (kg) | ÖLÇÜLER Dimensions (mm) | KOLİ AD. Pcs / Ctn | FİYAT Prices (\$) |
|---------------------------|--------------|------------------------|----------------------------|-----------------------|----------------------|
| VL458009 | 9W | 0,85 | 250 x 50 x 65 | 1 | 85,00 |
| VL458018 | 18W | 1,50 | 500 x 50 x 65 | 1 | 115,00 |
| VL458036 | 36W | 2,15 | 1000 x 50 x 65 | 1 | 170,00 |
| VL458001 - RGB kumanda | - | - | - | 1 | 10,00 |

LED LINEER ARMATÜRLER

LED Linear Luminaires



GÖVDE & CAM

Body & Glass

SÜRÜCÜ

Driver Type

KART

PCB

IŞIK RENGİ

Light Color

ÇALIŞMA VOLTAJI

Operating Voltage

ÇALIŞMA SICAKLIĞI

Operating Heat

VERİMLİLİK

Efficiency

KALİTE STANDARTI

Quality Standart

Alüminyum Profil

Aluminium Profile

PFC - Sabit Akım - Kısa Devre ve Aşırı Yük Korumalı

PFC - Constant Current - Short Circuit Overload Protected

Alüminyum

Aluminium

Gün Işığı - Soğuk Beyaz - Amber

Daylight - Cool White - Amber

220 V - 240 V AC 50 - 60 Hz

-30° / +70 °C

>92

TS 8700 EN 60598-2-1



LED renk (K) kullanım koşullarına göre opsiyoneldir.

LED color (K) it is optional according to the terms of use.



| ÜRÜN KODU Product Code | GÜÇ Power | ÜRÜN TİPİ Product Type | ÖLÇÜLER Dimensions (mm) | DIŞ MEKAN Outdoor (\$) | İÇ MEKAN Indoor (\$) |
|---------------------------|--------------|--------------------------------------------------------|----------------------------|---------------------------|-------------------------|
| VL448114 | 14W | Metrede 60 LED - 24V / 60 LED at 1 Meter - 24V | 1000 | 29,00 | 21,00 |
| VL448118 | 18W | Metrede 216 LED - 24V / 216 LED at 1 Meter - 24V | 1000 | 33,00 | 25,00 |
| VL448120 | 20W | Metrede 102 LED - 12V / 102 LED at 1 Meter - 12V | 1000 | 48,00 | 30,00 |
| VL448115-R | 15W | RGB Metrede 60 LED - 24V / 60 LED at RGB 1 Meter - 24V | 1000 | 40,00 | 32,00 |

LED PARK BAHÇE ARMATÜRLERİ

LED Park Garden Luminaires



VL550060



IP65

60.000
saat ömür

2 yıl
garantili

RoHS

GÖVDE & CAM

Body & Glass

SÜRÜCÜ

Driver Type

KART

PCB

ÇALIŞMA VOLTAJİ

Operating Voltage

ÇALIŞMA SICAKLIĞI

Operating Heat

VERİMLİLİK

Efficiency

KALİTE STANDARDI

Quality Standart

Alüminyum Gövde & Metal Taşıyıcı & Temperli Cam
Aluminium Body & Metal Carrier & Tempered Glass

PFC - Sabit Akım - Kısa Devre ve Aşırı Yük Korumalı
PFC - Constant Current - Short Circuit Overload Protected

Alüminyum
Aluminium

220 V - 240 V AC 50 - 60 Hz

-30^o / +70^oC

>%92



LED renk (K) ve mercek açılırları kullanım koşullarına göre opsiyoneldir.
LED color (K) and lens angle it is optional according to the terms of use.



| ÜRÜN KODU Product Code | GÜÇ Power | AÇIKLAMA Description | RENK SICAKLIĞI Kelvin | ÖLÇÜ Dimensions (mm) | FİYAT Prices (\$) |
|---------------------------|--------------|------------------------------|--------------------------|-------------------------|----------------------|
| VL550040 | 40W | 40W LED Park Bahçe | 6.000 K | Ø 735 x 775 x Ø100 | 300,00 |
| VL550060 | 60W | 60W LED Park Bahçe | 6.000 K | Ø 735 x 775 x Ø100 | 375,00 |
| VL550040-OPAL | 40W | 40W LED Park Bahçe -Opal | 6.000 K | Ø 735 x 775 x Ø100 | 350,00 |
| VL550060-OPAL | 60W | 60W LED Park Bahçe - Opal | 6.000 K | Ø 735 x 775 x Ø100 | 425,00 |
| VL551030-C | 30W | 30W LED Park Bahçe - Comfort | 6.000 K | Ø 280 x 780 x Ø80 | 200,00 |
| VL551060-C | 60W | 60W LED Park Bahçe - Comfort | 6.000 K | Ø 280 x 780 x Ø80 | 252,00 |
| Direk | - | 3 Metre DKP Sac (Boyalı) | - | - | 195,00 |



POLİKARBON GÖVDE & POLİKARBON CAM...

ETANJ ARMATÜRLER





KLASİK AYDINLATMA
CLASSIC LIGHTING

2016
COLLECTION

ELEKTRONİK BALASTLI T8 PARABOLİK OFİS ARMATÜRLERİ

Office Luminaires T8 Parabolic With Electronic Ballast



GÖVDE

Body

GÖVDE RENGİ

Body Color

REFLEKTÖR

Reflector

ÇALIŞMA VOLTAJI

Operating Voltage

BALAST

Ballast

KOMPONENT

Components

KALİTE STANDARDI

Quality Certificate

DKP Sac Gövde

DKP Steel Sheet Body

Elektrostatik Toz Boya

Electrostatic Powder Coated Sheet

0.40 mm Anodized Alüminyum

0.40 mm Anodised Aluminium



220 V - 240 V 50 Hz

Uzun Ömürlü Yüksek Verimli Elektronik Balast

High Performance Electronic Ballast

Konvektör Kit Opsiyonel Uygulanabilir

Emergency Kit 1-3 Hours (Optional)

TS 8698 EN 60598-2-2  

Elektronik Balastlar Philips, Tridonic veya Osram Markadır.

Brand of electronics ballasts made of Philips, Tridonic and Osram.

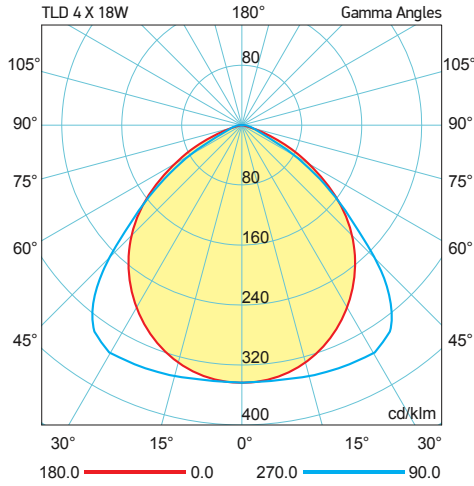

Acil kitli uygulamalarınız için lütfen fiyat sorunuz.

Please ask price with emergency kit applications.

| ÜRÜN KODU Product Code | Açıklama Description | GÜÇ Power | AĞIRLIK Weight (kg) | ÖLÇÜLER Dimensions (mm) | KOLİ AD. Pcs / Ctn | FİYAT Prices (TL) |
|---------------------------|----------------------------------------------------------------------------------------|--------------|------------------------|----------------------------|-----------------------|----------------------|
| VL340218 | T8 Sıva Altı Çift Parabolik Armatür Recessed Mounted Double T8 Parabolic Luminaires | 2x18W | 1,30 | 595 x 295 x 65 | 2 | 100,00 |
| VL340418 | T8 Sıva Altı Çift Parabolik Armatür Recessed Mounted Double T8 Parabolic Luminaires | 4x18W | 3,00 | 595 x 595 x 65 | 2 | 130,00 |
| VL341218 | T8 Sıva Üstü Çift Parabolik Armatür Surface Mounted Double T8 Parabolic Luminaires | 2x18W | 1,50 | 595 x 295 x 50 | 2 | 105,00 |
| VL341418 | T8 Sıva Üstü Çift Parabolik Armatür Surface Mounted Double T8 Parabolic Luminaires | 4x18W | 3,40 | 595 x 595 x 50 | 2 | 135,00 |

T5 PARABOLİK OFİS ARMATÜRLERİ

T5 Parabolic Office Luminaires



GÖVDE

Body

GÖVDE RENGİ

Body Color

REFLEKTÖR

Reflector

ÇALIŞMA VOLTAJİ

Operating Voltage

BALAST

Ballast

KOMPONENT

Components

KALİTE STANDARDI

Quality Certificate

DKP Sac Gövde

DKP Steel Sheet Body

Elektrostatik Toz Boya

Electrostatic Powder Coated Sheet

0.40 mm Anodized Alüminyum

0.40 mm Anodised Aluminium



220 V - 240 V 50 Hz

Uzun Ömürlü Yüksek Verimli Elektronik Balast

High Performance Electronic Ballast

Konvektör Kit Opsiyonel Uygulanabilir

Emergency Kit 1-3 Hours (Optional)

TS 8698 EN 60598-2-2  

Elektronik Balastlar Philips, Tridonic veya Osram Markadır.

Brand of electronics ballasts made of Philips, Tridonic and Osram.

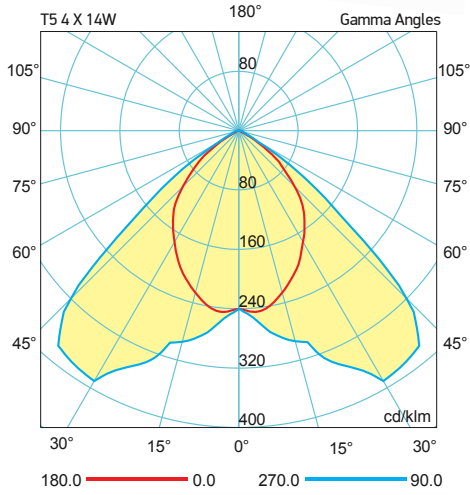

Acil kitli uygulamalarınız için lütfen fiyat sorunuz.

Please ask price with emergency kit applications.

| ÜRÜN KODU Product Code | Açıklama Description | GÜÇ Power | AĞIRLIK Weight (kg) | ÖLÇÜLER Dimensions (mm) | KOLİ AD. Pcs / Ctn | FİYAT Prices (TL) |
|---------------------------|----------------------------------------------------------------------------------------|--------------|------------------------|----------------------------|-----------------------|----------------------|
| VL342214 | T5 Siva Altı Çift Parabolik Armatür Recessed Mounted Double T5 Parabolic Luminaires | 2x14W | 1,30 | 595 x 295 x 65 | 2 | 135,00 |
| VL342414 | T5 Siva Altı Çift Parabolik Armatür Recessed Mounted Double T5 Parabolic Luminaires | 4x14W | 3,00 | 595 x 595 x 65 | 2 | 150,00 |
| VL343214 | T5 Siva Üstü Çift Parabolik Armatür Surface Mounted Double T5 Parabolic Luminaires | 2x14W | 1,50 | 595 x 295 x 50 | 2 | 135,00 |
| VL343414 | T5 Siva Üstü Çift Parabolik Armatür Surface Mounted Double T5 Parabolic Luminaires | 4x14W | 3,40 | 595 x 595 x 50 | 2 | 150,00 |

T5 YÜKSEK TAVAN ARMATÜRLER

T5 Fluorescent High Ceiling Luminaires



GÖVDE

Body

GÖVDE RENGİ

Body Color

CAM

Glass

REFLEKTÖR

Reflector

ÇALIŞMA VOLTAJI

Operating Voltage

BALAST

Ballast

KOMPONENT

Components

KALİTE STANDARDI

Quality Certificate

DKP Sac Gövde

DKP Steel Sheet Body

Elektrostatik Toz Boya

Electrostatic Powder Coated Sheet

Temperli Sekurit Cam

Tempered Security Glass

0.40 mm %99 Saflıkta Anodized Alüminyum

0.40 mm %99 Pure Anodised Aluminium



220 V - 240 V 50 Hz

Uzun Ömürlü Yüksek Verimli Elektronik Balast

High Performance Electronic Ballast

Konvektör Kit Opsiyonel Uygulanabilir

Applicable Optional Converter Kit

TS 8698 EN 60598-2-1  

Elektronik Balastlar Philips, Tridonic veya Osram Markadır.

Brand of electronics ballasts made of Philips, Tridonic and Osram.

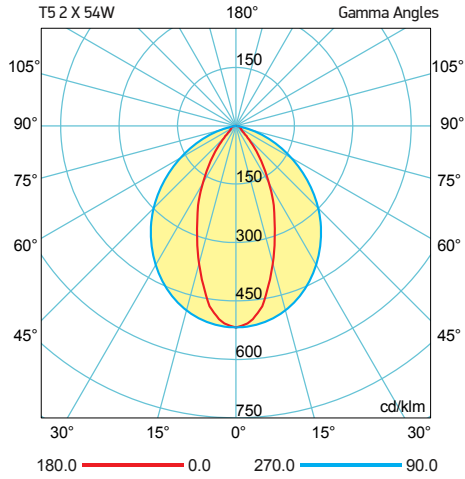
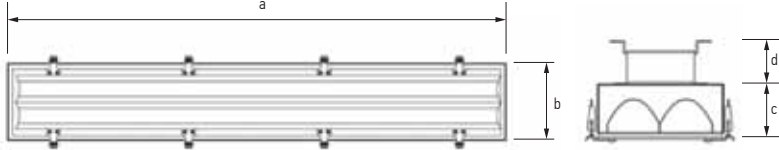

Acil kitli uygulamalarınız için lütfen fiyat sorunuz.

Please ask price with emergency kit applications.

| ÜRÜN KODU Product Code | GÜÇ Power | AĞIRLIK Weight (kg) | ÖLÇÜLER / Dimensions (mm) a x b x c x d | KOLİ AD. Pcs / Ctn | FIYAT Prices (TL) |
|---------------------------|--------------|------------------------|--------------------------------------------|-----------------------|----------------------|
| VL344254 | 2x54W | 8,30 | 1210 x 190 x 90 x 23 | 1 | 255,00 |
| VL344280 | 2x80W | 9,20 | 1510 x 190 x 90 x 23 | 1 | 308,00 |

POLİKARBON GÖVDE - POLİKARBON CAM ETANJ ARMATÜRLER

Pc Bodied & Pc Glass Waterproof Luminaires

**GÖVDE**

Body

CAM

Glass

REFLEKTÖR

Reflector

ÇALIŞMA VOLTAJİ

Operating Voltage

BALAST

Ballast

KOMPONENT

Components

KALİTE STANDARDI

Quality Certificate

Polikarbon Gövde

PC Body

Polikarbon Cam

PC Glass

0.40 mm Sac, Elektrostatik Toz Boyalı

0.40 mm Electrostatic Powder Coated Sheet

220 V - 240 V 50 Hz

Uzun Ömürlü Yüksek Verimli Elektronik Balast

High Performance Electronic Ballast

Konvektör Kit Opsiyonel Uygulanabilir

Emergency Kit 1-3 Hours (Optional)

TS 8698 EN 60598-2-1



Elektronik Balastlar Philips, Tridonic veya Osram Markadır.

Brand of electronics ballasts made of Philips, Tridonic and Osram.

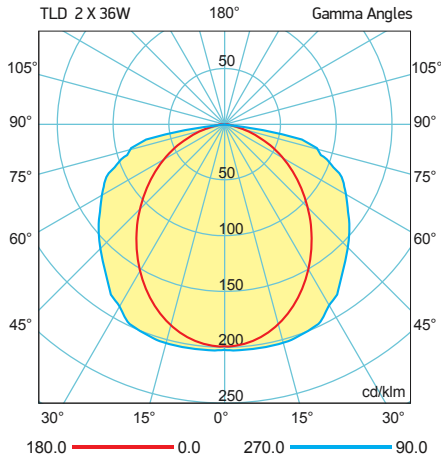

Acil kitli uygulamalarınız için lütfen fiyat sorunuz.

Please ask price with emergency kit applications.

| ÜRÜN KODU Product Code | GÜÇ Power | AĞIRLIK Weight (kg) | ÖLÇÜLER Dimensions (mm) | KOLİ AD. Pcs / Ctn | FİYAT Prices (TL) |
|---------------------------|--------------|------------------------|----------------------------|-----------------------|----------------------|
| VL362118 | 1x18 | 1,75 | 675 x 80 x 85 | 16 | 66,00 |
| VL362218 | 2x18 | 1,85 | 675 x 120 x 85 | 10 | 71,00 |
| VL362136 | 1x36 | 2,40 | 1250 x 80 x 85 | 14 | 81,00 |
| VL362236 | 2x36 | 3,50 | 1250 x 120 x 85 | 10 | 88,00 |
| VL362158 | 1x58 | 2,15 | 1550 x 80 x 85 | 10 | 106,00 |
| VL362258 | 2x58 | 2,60 | 1550 x 120 x 85 | 8 | 123,00 |

T5 Elektronik Balastlı / T5 Electronic Ballast

T5 POLİKARBON GÖVDE - POLİKARBON CAM ETANJ ARMATÜRLER

T5 Pc Bodied & Pc Glass Waterproof Luminaires



GÖVDE

Body

Polikarbon Gövde

PC Body

CAM

Glass

Polikarbon Cam

PC Glass

REFLEKTÖR

Reflector

0.40 mm Sac, Elektrostatic Toz Boyalı
0.40 mm Electrostatic Powder Coated Sheet

ÇALIŞMA VOLTAJ

Operating Voltage

220 V - 240 V 50 Hz

BALAST

Ballast

Uzun Ömürlü Yüksek Verimli Elektronik Balast
High Performance Electronic Ballast

KOMPONENT

Components

Konvektör Kit Opsiyonel Uygulanabilir
Emergency Kit 1-3 Hours (Optional)

KALİTE STANDARTI

Quality Certificate

TS 8698 EN 60598-2-1



Elektronik Balastlar Philips, Tridonic veya Osram Markadır.

Brand of electronics ballasts made of Philips, Tridonic and Osram.

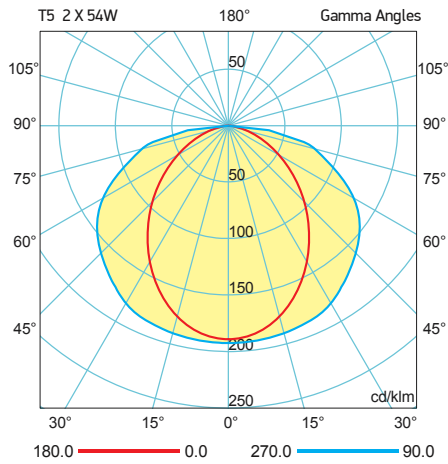

Acil kitli uygulamalarınız için lütfen fiyat sorunuz.

Please ask price with emergency kit applications.

| ÜRÜN KODU Product Code | GÜÇ Power | AĞIRLIK Weight (kg) | ÖLÇÜLER Dimensions (mm) | KOLİ AD. Pcs / Ctn | FIYAT Prices (TL) |
|---------------------------|--------------|------------------------|----------------------------|-----------------------|----------------------|
| VL363114 | 1x14 | 1,25 | 675 x 80 x 85 | 16 | 71,00 |
| VL363214 | 2x14 | 1,45 | 675 x 120 x 85 | 10 | 76,00 |
| VL363128 | 1x28 | 2,00 | 1250 x 80 x 85 | 14 | 86,00 |
| VL363228 | 2x28 | 2,80 | 1250 x 120 x 85 | 10 | 95,00 |
| VL363154 | 1x54 | 2,80 | 1250 x 120 x 85 | 10 | 110,00 |
| VL363254 | 2x54 | 2,80 | 1250 x 120 x 85 | 10 | 130,00 |

POLİMER ENJEKSİYON YOL VE CADDE ARMATÜRLERİ

Polymer Injection Street Luminaires

**GÖVDE**

Body

Polimer Enjeksiyon

Polymer Injection

CAM

Glass

Temperli Sekurit Cam

Tempered Security Glass

REFLEKTÖR

Reflector

0.40 mm %99 Safılıkta Anodized Alüminyum

0.40 mm %99 Pure Anodised Aluminium

ÇALIŞMA VOLTAJI

Operating Voltage

220 V - 240 V 50 Hz

GÖVDE ISI DAYANIMI

Body Heating Strength

-40° / +140 °C

KALİTE STANDARTI

Quality Standart

TS 8700 EN 60598-2-3

**BALAST**

Ballast

TS 60923 EN 61347-2-9

**ATEŞLEYİCİ**

Ignitor

EN 61347-2-1

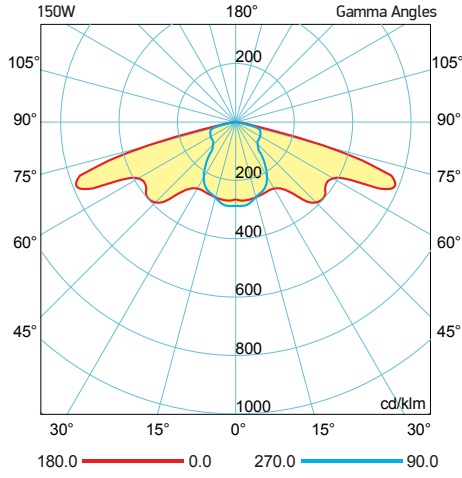

| ÜRÜN KODU Product Code | GÜÇ Power | AĞIRLIK Weight (kg) | ÖLÇÜLER Dimensions (mm) | KOLİ AD. Pcs / Ctn | FIYAT Prices (TL) |
|---------------------------|---------------------------------------------------|------------------------|----------------------------|-----------------------|----------------------|
| VL326050 | 50W Sodyum 50W Sodium | 3,20 | 290 x 590 x 130 | 1 | 140,00 |
| VL326070 | 70W Sodyum 70W Sodium | 3,25 | 290 x 590 x 130 | 1 | 150,00 |
| VL326100 | 100W Sodyum 100W Sodium | 3,60 | 290 x 590 x 130 | 1 | 160,00 |
| VL326150 | 150W Sodyum Küçük Gövde 150W Sodium Small Body | 4,00 | 290 x 590 x 130 | 1 | 180,00 |

POLİMER ENJEKSİYON YOL VE CADDE ARMATÜRLERİ

Polymer Injection Street Luminaires



GÖVDE

Body

Glass

Reflektör

REFLEKTÖR

Reflector

ÇALIŞMA VOLTAJİ

Operating Voltage

GÖVDE ISI DAYANIMI

Body Heating Strength

KALİTE STANDARTI

Quality Standart

BALAST

Ballast

ATEŞLEYİCİ

Ignitor

Polimer Enjeksiyon

Polymer Injection

Temperli Sekurit Cam

Tempered Security Glass

0.40 mm %99 Saflıkta Anodized Alüminyum

0.40 mm %99 Pure Anodised Aluminium

220 V - 240 V 50 Hz

-40° / +140 °C

TS 8700 EN 60598-2-3

TS 60923 EN 61347-2-9

EN 61347-2-1

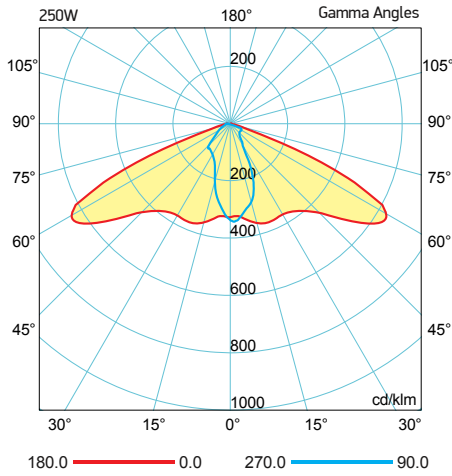

| ÜRÜN KODU Product Code | GÜÇ Power | AĞIRLIK Weight (kg) | ÖLÇÜLER Dimensions (mm) | KOLİ AD. Pcs / Ctn | FIYAT Prices (TL) |
|---------------------------|-------------------------------------------------|------------------------|----------------------------|-----------------------|----------------------|
| VL307150 | 150W Sodyum Büyük Gövde 150W Sodium Big Body | 6,50 | 710 x 350 x 210 | 1 | 200,00 |
| VL307250 | 250W Sodyum 250W Sodium | 6,80 | 710 x 350 x 210 | 1 | 265,00 |
| VL307400 | 400W Sodyum 400W Sodium | 8,70 | 710 x 350 x 210 | 1 | 290,00 |

ALÜMİNYUM ENJEKSİYON YOL VE CADDE ARMATÜRLERİ

Aluminium Injection Highway and Street Luminaires



GÖVDE

Body

Alüminyum Enjeksiyon

Aluminium Injection

CAM

Glass

Temperli Sekurit Cam

Tempered Security Glass

REFLEKTÖR

Reflector

0.40 mm %99 Safılıkta Anodized Alüminyum

0.40 mm %99 Pure Anodised Aluminium

ÇALIŞMA VOLTAJI

Operating Voltage

220 V - 240 V 50 Hz

GÖVDE ISI DAYANIMI

Body Heating Strength

-40° / +140 °C

KALİTE STANDARTI

Quality Standart

TS 8700 EN 60598-2-3



BALAST

Ballast

TS 60923 EN 61347-2-9



ATEŞLEYİCİ

Ignitor

EN 61347-2-1

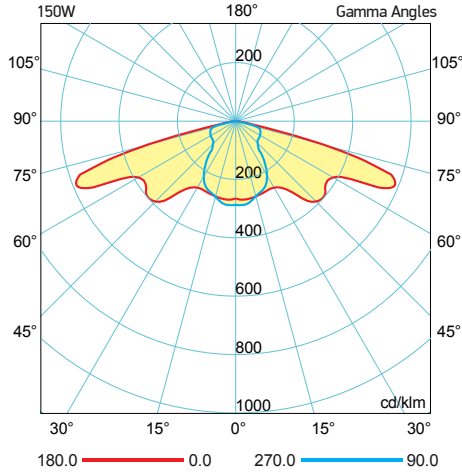

| ÜRÜN KODU Product Code | GÜÇ Power | AĞIRLIK Weight (kg) | ÖLÇÜLER Dimensions (mm) | KOLİ AD. Pcs / Ctn | FİYAT Prices (TL) |
|---------------------------|---------------------------------------------------|------------------------|----------------------------|-----------------------|----------------------|
| VL326050 | 50W Sodyum 50W Sodium | 4,70 | 290 x 590 x 130 | 1 | 190,00 |
| VL327070 | 70W Sodyum 70W Sodium | 4,80 | 290 x 590 x 130 | 1 | 195,00 |
| VL327100 | 100W Sodyum 100W Sodium | 5,50 | 290 x 590 x 130 | 1 | 210,00 |
| VL326150 | 150W Sodyum Küçük Gövde 150W Sodium Small Body | 5,50 | 290 x 590 x 130 | 1 | 230,00 |

ALÜMİNYUM ENJEKSİYON YOL VE CADDE ARMATÜRLERİ

Aluminium Injection Highway and Street Luminaires



GÖVDE

Body

Alüminyum Enjeksiyon

Aluminium Injection

CAM

Glass

Temperli Sekurit Cam

Tempered Security Glass

REFLEKTÖR

Reflector

0.40 mm %99 Saflıkta Anodized Alüminyum

0.40 mm %99 Pure Anodised Aluminium

ÇALIŞMA VOLTAJI

Operating Voltage

220 V - 240 V 50 Hz

GÖVDE ISI DAYANIMI

Body Heating Strength

-40° / +140 °C

KALİTE STANDARTI

Quality Standart

TS 8700 EN 60598-2-3

BALAST

Ballast

TS 60923 EN 61347-2-9

ATEŞLEYİCİ

Ignitor

EN 61347-2-1

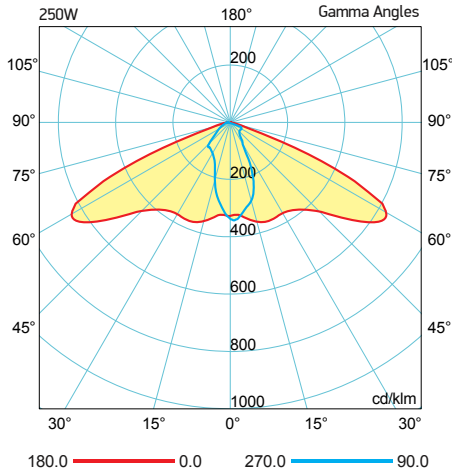

| ÜRÜN KODU Product Code | GÜÇ Power | AĞIRLIK Weight (kg) | ÖLÇÜLER Dimensions (mm) | KOLİ AD. Pcs / Ctn | FIYAT Prices (TL) |
|---------------------------|-------------------------------------------------|------------------------|----------------------------|-----------------------|----------------------|
| VL327150 | 150W Sodyum Büyük Gövde 150W Sodium Big Body | 8,00 | 705 x 370 x 190 | 1 | 300,00 |
| VL327250 | 250W Sodyum 250W Sodium | 8,60 | 705 x 370 x 190 | 1 | 405,00 |
| VL327400 | 400W Sodyum 400W Sodium | 10,00 | 705 x 370 x 190 | 1 | 445,00 |

POLYESTER GÖVDE PROJEKTÖRLER

Polyester Bodied Floodlight



GÖVDE

Body

GÖVDE RENGİ

Body Color

CAM

Glass

REFLEKTÖR

Reflector

ÇALIŞMA VOLTAJİ

Operating Voltage

GÖVDE ISI DAYANIMI

Body Heating Strength

KALİTE STANDARDI

Quality Standart

BALAST

Ballast

ATEŞLEYİCİ

Ignitor

CTP Cam Elyaf Takviyeli Polyester

GRP Glass Fiber Reinforced Polyester

Siyah

Black

Isıya ve Darbelere Dayanıklı Temperli Cam



Tempered Glass

0.40 mm %99 Alüminyum

0.40 mm %99 Aluminium

220 V - 240 V 50 Hz

-40⁰ / +140⁰ C

TS 8702 EN 60598-2-5  

250W - 400W Metal Halide ve Sodyum Balast

250W - 400W High Pressure Sodium and Metal Ballast

EN 60923 - EN 61347-2-9

EN 61347-2-1



*VL387200 Alüminyum Döküm Gövde

*VL387200 Cast Aluminium



| ÜRÜN KODU Product Code | GÜÇ Power | AĞIRLIK Weight (kg) | ÖLÇÜLER Dimensions (mm) | KOLİ AD. Pcs / Ctn | FİYAT Prices (TL) |
|---------------------------|------------------------------|------------------------|----------------------------|-----------------------|----------------------|
| VL386250 | 250W Metal 250W Metal | 7,30 | 445 x 420 x 150 | 1 | 180,00 |
| VL387250 | 250W Sodyum 250W Sodium | 7,30 | 445 x 420 x 150 | 1 | 180,00 |
| VL386400 | 400W Metal 400W Metal | 8,30 | 445 x 420 x 150 | 1 | 185,00 |
| VL387400 | 400W Sodyum 400W Sodium | 8,50 | 445 x 420 x 150 | 1 | 197,00 |
| VL386100 | 1000W Metal 1000W Metal | 17,50 | 510 x 600 x 200 | 1 | 500,00 |
| VL387100 | 1000W Sodyum 1000W Sodium | 17,50 | 510 x 600 x 200 | 1 | 500,00 |
| VL387200* | 2000W Metal 2000W Metal | 16,00 | 500 x 510 x 260 | 1 | 1.600,00 |

ALÜMİNYUM DÖKÜM STAD PROJKTÖRÜ

Cast Aluminium Floodlight



GÖVDE

Body

Alüminyum Döküm

Cast Aluminium

GÖVDE RENGİ

Body Color

RAL 7035 (Pütürlü Gri)

RAL 7035 (Rough Grey)

CAM

Glass

Isiya ve Darbelere Dayanıklı Temperli Cam

Tempered Glass

REFLEKTÖR

Reflector

0.40 mm %99 Alüminyum Reflektör

0.40 mm %99 Aluminium Reflector

ÇALIŞMA VOLTAJI

Operating Voltage

380 V 50 Hz

GÖVDE ISI DAYANIMI

Body Heating Strength

-40° / +140 °C

KALİTE STANDARTI

Quality Standart

TS 8702 EN 60598-2-5



BALAST

Ballast

EN 60923 EN 61347-2-9

ATEŞLEYİCİ

Ignitor

2000 W - 380 V (Uzaktan Ateşlemeli Tip)

Remote Ignition Type

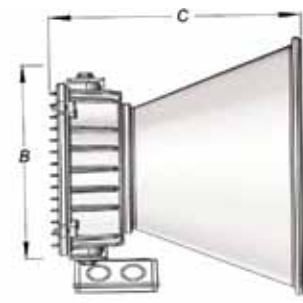
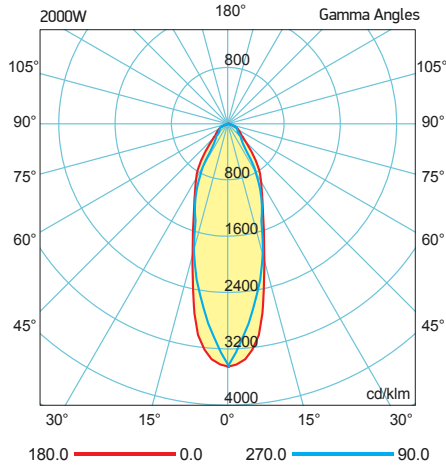

| ÜRÜN KODU Product Code | GÜÇ Power | Lamba Lamp | AĞIRLIK Weight (kg) | ÖLÇÜLER Dimensions (mm) | KOLİ AD. Pcs / Ctn | FİYAT Prices (TL) |
|---------------------------|----------------------------|---------------|------------------------|----------------------------|-----------------------|----------------------|
| VL382000 | 2000W Metal 2000W Metal | MHN - LA | 13,50 | 520 x 345 x 470 | 1 | 2.000,00 |





SOLAR AYDINLATMA
SOLAR LIGHTING



2016
COLLECTION

SOLAR AYDINLATMA SİSTEMLERİ

Solar Lighting Systems

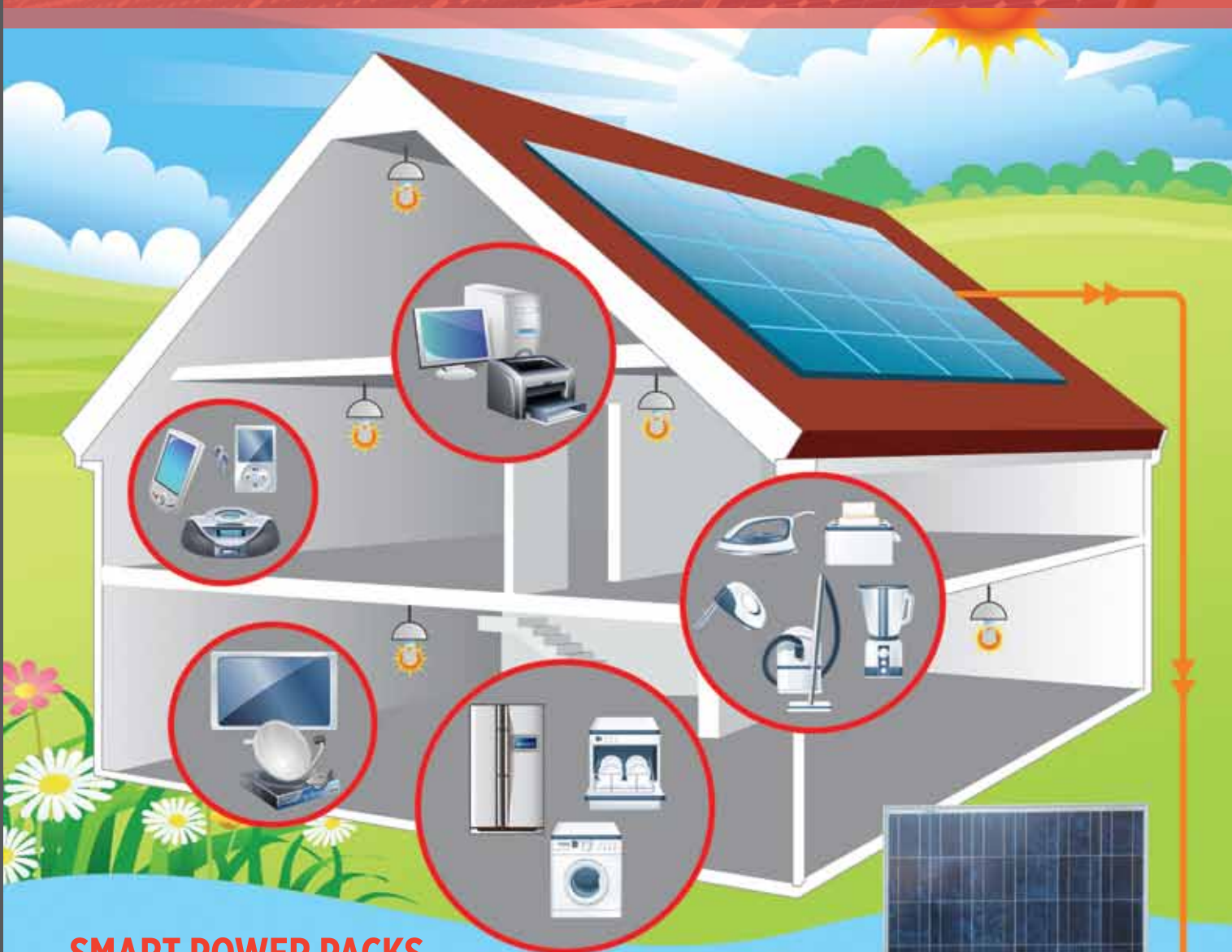

SMART POWER PACKS

- Akıllı Akü Şarj Özelliği
- Jeneratör Destekli Çalışma
- Şebeke ve Jeneratör Aktif Değilken Aküden Çalışabilme
- Aşırı Akım ve Gerilim Koruması
- Uygulamaya Dayalı Seçilebilir Şarj Akımı
- Yüksek Verim. Yük Yokken Uyku Moduna Geçme Özelliği
- Kolay Kurulum, Kapsamlı LCD Ekran

Kapsamlı LCD Ekran

Dört işlem düğmesi ve 3 uyarı ışığı ile çok kolay anlaşılabilir ve işlem yapma, LCD göstergisi de genel durum bilgisi. Giriş çıkış ve güç bilgileri okunabilmektedir.

LCD Ekran'dan ayarlanabilenler

- Güneş Enerjisi veya Şebeke Önceliği
- Akü Şarj Akımı
- Giriş Gerilim Aralığı



ŞEBEKEDEN
BAĞIMSIZ
ADALAMA
SİSTEMLERİ

SOLAR AYDINLATMA SİSTEMLERİ - UYGULAMA SEÇENEKLERİ

Solar Lighting Systems - Application Options

YVZ SLR 1P

| SIRA NO | MALZEME ADI | MİKTAR | BİRİM |
|---------|-------------------------------------------------|---------|-------|
| 1 | CWT-150-36P Güneş Paneli | 2 | Adet |
| 2 | 65 Ah/12 V Akü | 2 | Adet |
| 3 | KS 1000 800W Tam Sinüs Invertör Charger (50 Ah) | 1 | Adet |
| 4 | MC4 Konnektör (1 Adet Kutuda Sabit) | 3 | Set |
| 5 | MC4 Brunch Konnektör | 1 | Set |
| 6 | 6 mm Solar Kablo | 20 | Metre |
| 7 | Ara Bağlantı Ekipmanları | Çeşitli | - |
| 8 | Terminal Kutusu T3 | 1 | Adet |
| 9 | Akü Kutusu T3 | 1 | Adet |



ÖRNEK TÜKETİM TABLOSU (Kullanılan Ürünler)

| CİHAZ | ADET | GÜCÜ | ÇALIŞMA SAATİ | ENRJ. İHTİYACI |
|-----------------------------------|------|------|---------------|----------------|
| Televizyon 60 Ekran | 1 | 90 | 4 | 360 |
| Notebook Bilgisayar | 1 | 75 | 3 | 225 |
| 11W Lamba | 4 | 11 | 4 | 176 |
| 6W Lamba | 4 | 6 | 4 | 96 |
| Cep Telefonu Şarjı | 1 | 5 | 5 | 25 |
| TOPLAM ENERJİ İHTİYACI (W) | | | | 882 |
| GEREKEN AKIM DEĞERİ (A) | | | | 73,50 |



YVZ SLR 2P

| SIRA NO | MALZEME ADI | MİKTAR | BİRİM |
|---------|-------------------------------------------------|---------|-------|
| 1 | CWT-150-36P Güneş Paneli | 3 | Adet |
| 2 | 100 Ah/12 V Akü | 2 | Adet |
| 3 | KS 1000 800W Tam Sinüs Invertör Charger (50 Ah) | 1 | Adet |
| 4 | MC4 Konnektör (1 Adet Kutuda Sabit) | 5 | Set |
| 5 | MC4 Brunch Konnektör | 2 | Set |
| 6 | 6 mm Solar Kablo | 23 | Metre |
| 7 | Ara Bağlantı Ekipmanları | Çeşitli | - |
| 8 | Terminal Kutusu T3 | 1 | Adet |
| 9 | Akü Kutusu T3 | 1 | Adet |



ÖRNEK TÜKETİM TABLOSU (Kullanılan Ürünler)

| CİHAZ | ADET | GÜCÜ | ÇALIŞMA SAATİ | ENRJ. İHTİYACI |
|-----------------------------------|------|------|---------------|----------------|
| Buzdolabı A** | 1 | 30 | 24 | 720 |
| Televizyon 60 Ekran | 1 | 80 | 3 | 240 |
| Notebook Bilgisayar | 1 | 75 | 1 | 75 |
| 11W Lamba | 5 | 11 | 5 | 275 |
| Cep Telefonu Şarjı | 1 | 5 | 5 | 25 |
| TOPLAM ENERJİ İHTİYACI (W) | | | | 1.335 |
| GEREKEN AKIM DEĞERİ (A) | | | | 111,25 |



SOLAR AYDINLATMA SİSTEMLERİ - UYGULAMA SEÇENEKLERİ

Solar Lighting Systems - Application Options

YVZ SLR 3P

| SIRA NO | MALZEME ADI | MİKTAR | BİRİM |
|---------|--------------------------------------------------|---------|-------|
| 1 | CWT-250-60P Güneş Paneli | 2 | Adet |
| 2 | 100 Ah/12 V Akü | 2 | Adet |
| 3 | KS 3000 2400W Tam Sinüs İnvörtör Charger (50 Ah) | 1 | Adet |
| 4 | MC4 Konnektör (1 Adet Kutuda Sabit) | 3 | Set |
| 5 | MC4 Brunch Konnektör | 1 | Set |
| 6 | 6 mm Solar Kablo | 20 | Metre |
| 7 | Ara Bağlantı Ekipmanları | Çeşitli | - |
| 8 | Terminal Kutusu T4 | 1 | Adet |
| 9 | Akü Kutusu T4 | 1 | Adet |



ÖRNEK TÜKETİM TABLOSU (Kullanılan Ürünler)

| CİHAZ | ADET | GÜCÜ | ÇALIŞMA SAATİ | ENRJ. İHTİYACI |
|-----------------------------------|------|------|---------------|----------------|
| Buzdolabı A++ | 1 | 50 | 24 | 1200 |
| Televizyon 60 Ekran | 1 | 100 | 4 | 400 |
| 11W Lamba | 2 | 11 | 5 | 110 |
| Cep Telefonu Şarjı | 1 | 5 | 5 | 25 |
| TOPLAM ENERJİ İHTİYACI (W) | | | | 1.735 |
| GEREKEN AKIM DEĞERİ (A) | | | | 72,29 |



YVZ SLR 4P

| SIRA NO | MALZEME ADI | MİKTAR | BİRİM |
|---------|--------------------------------------------------|---------|-------|
| 1 | CWT-250-60P Güneş Paneli | 3 | Adet |
| 2 | 150 Ah/12 V Akü | 2 | Adet |
| 3 | KS 3000 2400W Tam Sinüs İnvörtör Charger (50 Ah) | 1 | Adet |
| 4 | MC4 Konnektör (1 Adet Kutuda Sabit) | 5 | Set |
| 5 | MC4 Brunch Konnektör | 2 | Set |
| 6 | 6 mm Solar Kablo | 23 | Metre |
| 7 | Ara Bağlantı Ekipmanları | Çeşitli | - |
| 8 | Terminal Kutusu T4 | 1 | Adet |
| 9 | Akü Kutusu T4 | 1 | Adet |



ÖRNEK TÜKETİM TABLOSU (Kullanılan Ürünler)

| CİHAZ | ADET | GÜCÜ | ÇALIŞMA SAATİ | ENRJ. İHTİYACI |
|-----------------------------------|------|------|---------------|----------------|
| Buzdolabı A++ | 1 | 50 | 24 | 1200 |
| Televizyon 60 Ekran | 1 | 100 | 8 | 800 |
| Notebook Bilgisayar | 1 | 90 | 3 | 270 |
| 1W Lamba | 3 | 11 | 10 | 330 |
| Cep Telefonu Şarjı | 1 | 5 | 6 | 30 |
| TOPLAM ENERJİ İHTİYACI (W) | | | | 2.630 |
| GEREKEN AKIM DEĞERİ (A) | | | | 109,58 |



SOLAR AYDINLATMA SİSTEMLERİ - UYGULAMA SEÇENEKLERİ

Solar Lighting Systems - Application Options

YVZ SLR 5P

| SIRA NO | MALZEME ADI | MİKTAR | BİRİM |
|---------|--------------------------------------------------|---------|-------|
| 1 | CWT-250-60P Güneş Paneli | 4 | Adet |
| 2 | 100 Ah/12 V Akü | 4 | Adet |
| 3 | KS 5000 4000W Tam Sinüs Invertör Charger (50 Ah) | 1 | Adet |
| 4 | MC4 Konnektör (1 Adet Kutuda Sabit) | 5 | Set |
| 5 | MC4 Brunch Konnektör | 1 | Set |
| 6 | 6 mm Solar Kablo | 23 | Metre |
| 7 | Ara Bağlantı Ekipmanları | Çeşitli | - |
| 8 | Terminal Kutusu T5 | 1 | Adet |
| 9 | Akü Kutusu T5 | 2 | Adet |

ÖRNEK TÜKETİM TABLOSU (Kullanılan Ürünler)

| CİHAZ | ADET | GÜCÜ | ÇALIŞMA SAATİ | ENRJ. İHTİYACI |
|-----------------------------------|------|------|---------------|----------------|
| Buzdolabı A++ | 1 | 75 | 24 | 1800 |
| Televizyon 81 Ekran | 1 | 120 | 9 | 720 |
| Notebook Bilgisayar | 1 | 90 | 3 | 270 |
| 11W Lamba | 7 | 11 | 5 | 385 |
| 7W Lamba | 5 | 7 | 5 | 175 |
| Cep Telefonu Şarjı | 1 | 5 | 24 | 120 |
| TOPLAM ENERJİ İHTİYACI (W) | | | | 3.470 |
| GEREKEN AKIM DEĞERİ (A) | | | | 72,29 |



YVZ SLR 6P

| SIRA NO | MALZEME ADI | MİKTAR | BİRİM |
|---------|--------------------------------------------------|---------|-------|
| 1 | CWT-250-60P Güneş Paneli | 6 | Adet |
| 2 | 100 Ah/12 V Akü | 4 | Adet |
| 3 | KS 5000 4000W Tam Sinüs Invertör Charger (50 Ah) | 1 | Adet |
| 4 | MC4 Konnektör (2 Adet Kutuda Sabit) | 8 | Set |
| 5 | MC4 Brunch Konnektör | 2 | Set |
| 6 | 6 mm ² Solar Kablo | 26 | Metre |
| 7 | Ara Bağlantı Ekipmanları | Çeşitli | - |
| 8 | Terminal Kutusu T5 | 1 | Adet |
| 9 | Akü Kutusu T5 | 2 | Adet |

ÖRNEK TÜKETİM TABLOSU (Kullanılan Ürünler)

| CİHAZ | ADET | GÜCÜ | ÇALIŞMA SAATİ | ENRJ. İHTİYACI |
|-----------------------------------|------|------|---------------|----------------|
| Buzdolabı A* | 1 | 75 | 24 | 1800 |
| Televizyon 60 Ekran | 1 | 100 | 10 | 1000 |
| Notebook Bilgisayar | 1 | 90 | 8 | 720 |
| 11W Lamba | 6 | 11 | 10 | 660 |
| 7W Lamba | 8 | 6 | 10 | 480 |
| Cep Telefonu Şarjı | 1 | 5 | 24 | 120 |
| TOPLAM ENERJİ İHTİYACI (W) | | | | 4.780 |
| GEREKEN AKIM DEĞERİ (A) | | | | 99,58 |



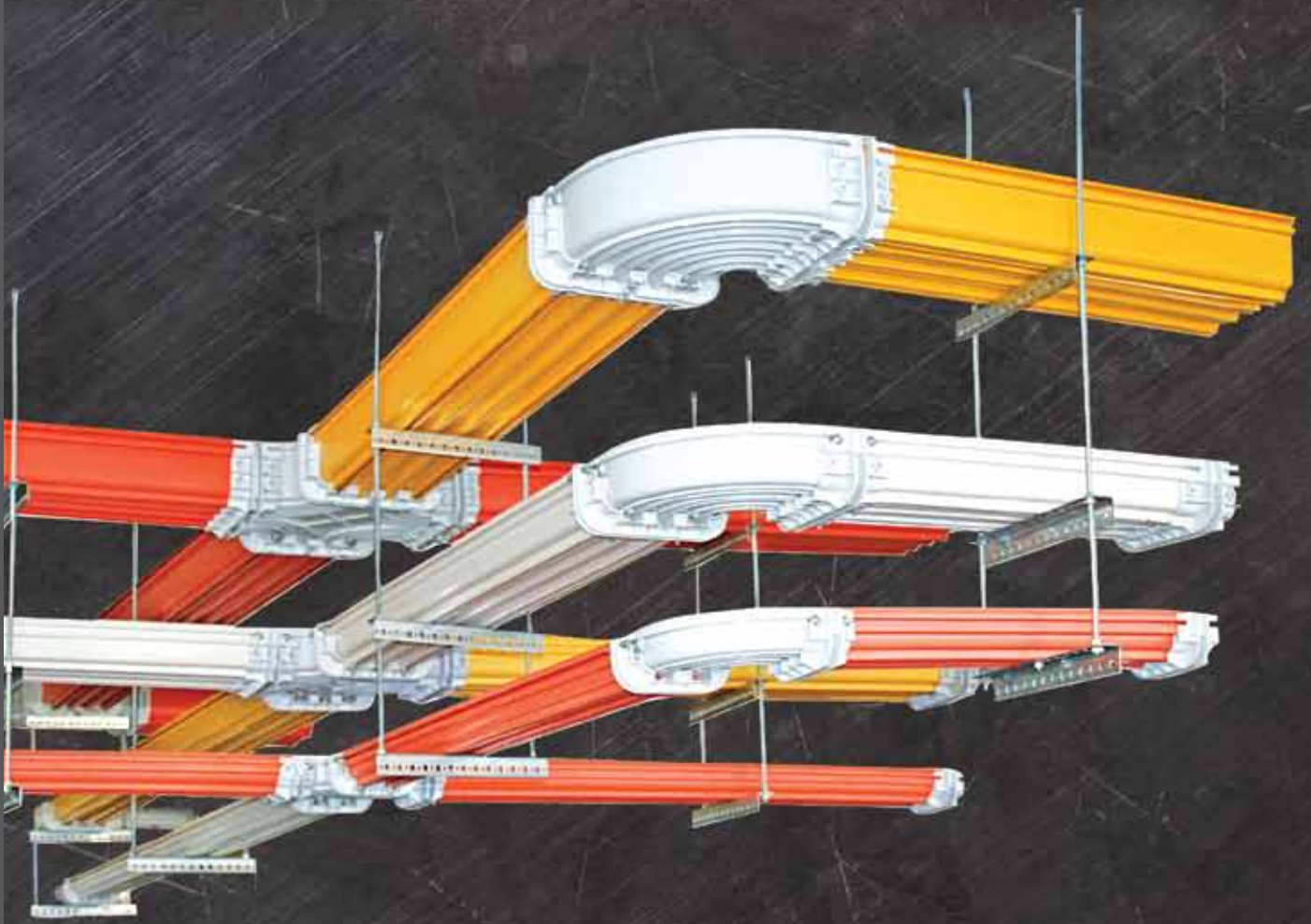



PVC KABLO TAŐIMA TAVALARI

PVC CABLE CARRIAGE TRAYS

2016
COLLECTION

YAVUZ KABLO TAŞIMA SİSTEMLERİ

YAVUZ KABLO TAŞIMA SİSTEMLERİ, hızla değişen dünyada modern teknoloji ve endüstriyel dönüşümlere uygun, enerji, ses, veri, görüntü gibi kablo sistemlerinin kolay, modern, güvenli, çevreye ve sağlığa zararsız bir şekilde taşınmasını sağlayan, sac, galvaniz kablo taşıma kanallarına alternatif olarak, modern teknoloji ile üretilen bir kablo taşıma sistemidir.

YAVUZ KABLO TAŞIMA SİSTEMLERİ, data kablolarından fiber optik kablolarına kadar geniş bir yelpazede kablo taşımaya olanak sağlar. Parçalı ve kolaylıkla sökülüp takılabilen opsiyonları sayesinde kolaylıkla montaj edilebilmektedir. Kanal mukavemetinin yüksek olması sayesinde, ağır kabloların

taşınmasında alternatifidir. Halojen Free yapısı sayesinde oluşabilecek yangınlarda ısıya dayanıklı olduğu için yangının yayılmasını ve çevreye zehirli gaz yayılmasını engeller. Fiber optik ve data kablolarının taşınmasında en güvenilir üründür.

Hammaddesi sayesinde uzun ömürlü çürüme ve korozyona dayanıklı bir sistemdir.

Geri dönüşümlü bir ürün olması sayesinde çevreyi korur. Enerji kablolarında oluşabilecek kısa devre ve dezenformasyonlarda yüksek emniyet ve güvenlik sağlar. Darbeye dayanıklılığı sayesinde çeşitli endüstriyel üretim alanlarında rahatlıkla kullanılabilir.



YAVUZ CABLE CARRIAGE SYSTEMS

YAVUZ CABLE CARRIAGE SYSTEMS is a cable tray system that is produced by using modern technology and it has become an alternative for metal, galvanized cable tray systems. The system of plastica ensures easy, modern, safe, the harmless transportation (for both environment and health) of cable systems such as energy, sound, data and display that is suitable for modern technology and industrial transformation in the rapidly changing world.

YAVUZ CABLE CARRIAGE SYSTEMS enables cable carrying in a wide range starting from the data cables to the fiber optic ones. The whole system can be easily mounted by the options of its smoothly demountable pieces. It is resistant against the

transportation of heavy cables due to its channel strength.

By means of halogen-free structure, **YAVUZ CABLE CARRIAGE SYSTEMS** prevents enlargement of toxic gases to the environment in a potential fire out situation.

YAVUZ CABLE CARRIAGE SYSTEMS is the most reliable product for the transportation of fiber optic and data cables. **YAVUZ CABLE CARRIAGE SYSTEMS** is resistant against decay and corrosion through its raw material.

It protects the environment for the being a recycling product. It assures high security and safety conditions against the probable short circuits in the energy cables. By the resistant against impact it might be used easily in various industrial production areas.

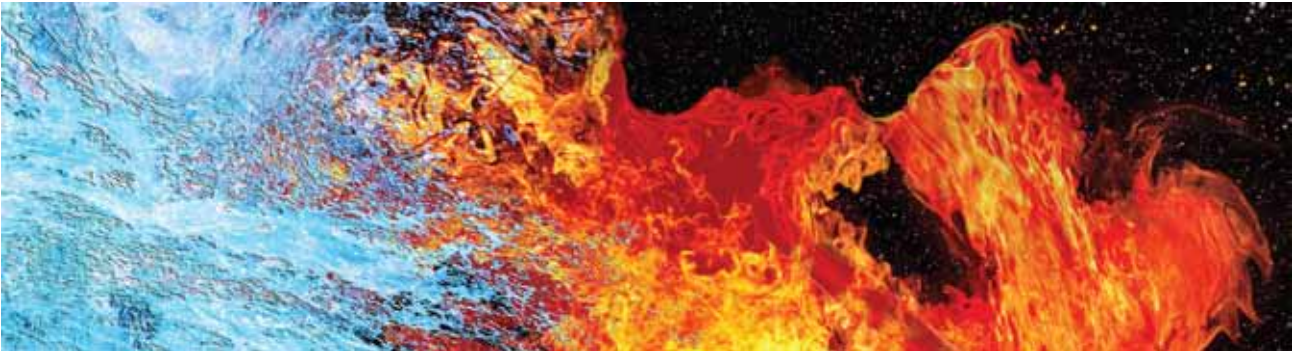

YAVUZ KABLO TAŞIMA SİSTEMLERİ TEKNİK ÖZELLİKLER

HAMMADDE: S/40 PVC hammaddesinden üretilen (CH₂ - CH₂) polimer bir türdür. Bu polimer madde, çeşitli katkı maddeleri ile harmanlandıktan sonra yüksek sıcaklıklarda şekil alarak plastik haline dönüşür ve mamül üretimine hazır hale getirilir. Hammadde test sonuçları aşağıdaki gibidir.

- Sertlik değeri 83 - 85 Sh
- 120 °C vida sıcaklığı
- 90 °C test giriş sıcaklığı
- 250 °C test çıkış sıcaklığı
- Alev karşı kendinden sönmeye özelliğine uygundur
- Ağırlık taşıma kapasitesi 120 kg. (1mt içiç)

ISI DAYANIMI VE YANMAZLIK:

• S40 PVC hammaddeli kablo kanalları 70 °C'ye kadar ısı dayanımına ve alevlere karşı mukavemet gösterme özelliğine sahiptir.

• Alev almaz ve zehirli gaz dışarı vermez.

DARBE DAYANIMI VE DEFORMASYON: Hammaddenin çekme ve sertlik değerleri 83 - 85 Sh ortalamasındadır. Bu ortalama baz alındığında ürünün taşıdığı noktasal ağırlık kapasitesi

120 kg'dır.

- Belirli düzeyde darbelere karşı yüksek dayanım özelliğine sahiptir.
- İçeriğinde barındırdığı kimyasal katkıları sayesinde çürümez ve deforme olmaz.

GÜVENLİK: Enerji sistemlerinin bir uzantısı ve devamı olan kablolar çabuk alev alacak malzemelerdendir. Kabloların alev alması sonucu oluşacak olan yangında duman oluşturmaması ve zehirli madde içermemesi sayesinde can güvenliği sağlar.

• Halojen Free olan kanallar alevi iletmeyip yangının diğer bölgelere sıçramasını engeller.

• Enerji sistemlerinde oluşabilecek ark ve kısa devre gibi sorunlarda plastik olmayan kanallar iletkenlik özelliklerinden dolayı sistemin tamamında zararlı etkilere yol açabilmektedir. Plastik kablo kanalları ise yalıtkanlıkları sayesinde oluşabilecek zararları bertaraf eder.

ÇEVRE DOSTU: Plastikler bilindiği gibi çevreyi olumsuz etkileyen maddelerdir. Plastik kablo kanalları ise geri dönüşümü sağlanabilen bir hammaddeden üretildiği için doğaya geri dönüşümü hızlı bir şekilde sağlanabilmektedir.



YAVUZ CABLE CARRIAGE SYSTEMS SPECIFICATIONS

RAW MATERIAL: A kind of polymer (CH₂-CH₂) that is produced with S/40 PVC raw material. This polymer product after being mixed with various additions is shaped as plastic according to required temperature and then it has become ready to produce items.

The test results of raw material are written below;

- Hardness value 83 - 85 Sh
- Heat of screw 120 °C
- Heat of test input 90 °C
- Heat of test output 250 °C
- Self- extinguishing against fire
- Weight capacity 120 kg (per 1mt)

HEAT RESISTANCE:

• S40 PVC raw material used cable trays are resistant against heat resistant

+70 °C and fire out.

• It is flame proof and it is not spreading toxic gases.

IMPACT RESISTANCE AND DEFORMATION:

Pull-off value and hardness value of raw material are at the

average level of 83-85 Sh. According to this average, the capacity of point of gravity is about 120kg.

- It has high strength feature resisting impact at the noted levels.
- Due to including various chemical additions, it is indefectible and not deformed

SAFETY: The cables that are extension of energy systems are prone to be get fire easily.

At a probable fire condition, on account of including nontoxic materials it provides life safety.

• Halojen-free cables do not transmit the fire; as a result the fire cannot be expanded.

• Due to the fact that metal cable trays are conducting, they can be easily harmful on the whole system. In contrast PVC cable trays are insulator, and they can prevent the harmful impacts of short circuits.

ENVIRONMENT FRIENDLY: As it is known plastics are harmful for the nature. However; PVC cable trays are produced with a raw material that is suitable for recycling.

KABLO TAŞIYICI VE TAŞIYICI KAPAKLARI

Cable Trays and Trays Covers



GÖVDE

Body

ISI DAYANIMI

Heat Resistance

DARBE DAYANIMI

Impact Resistance

HAM MADDE

Raw Material

KALİTE STANDARTI

Quality Certificate

S / 40 PVC (CH2 - CH2) PVC

S / 40 PVC (CH2 - CH2) PVC

70 °C Alev Karşı Kendinden Sönme Özelliği

70 °C Halogen Free Nonflammable

83-85 Sh Noktasal Ağırlık Kapasitesi 120 kg (1m)

83-85 Sh Point Weight Capacity 120 kg (for 1m)

S / 40 PVC

S / 40 PVC

CE



Özel ve sarı renkli ürünler için lütfen fiyat sorunuz.

Please Ask Prices For Special and Yellow Colours.

| ÜRÜN KODU Product Code | AÇIKLAMA Details | AĞIRLIK Weight (kg) | ÖLÇÜLER Dimensions (mm) | AMBALAJ Package | FİYAT Prices (\$) |
|---------------------------|----------------------------|------------------------|----------------------------|--------------------|----------------------|
| YPC2410 | Kablo Tavaşı Cable Tray | 1.415 | 100 x 50 x 3 | 10 m | 6,80 |
| YPC2415 | Kablo Tavaşı Cable Tray | 1.913 | 150 x 70 x 3 | 10 m | 8,90 |
| YPC2420 | Kablo Tavaşı Cable Tray | 2.810 | 200 x 100 x 3 | 10 m | 11,75 |
| YPC2410 TK | Tava Kapağı Cover Pan | 0.524 | 100 x 3 | 10 m | 2,50 |
| YPC2415 TK | Tava Kapağı Cover Pan | 0.760 | 150 x 3 | 10 m | 3,70 |
| YPC2420 TK | Tava Kapağı Cover Pan | 0.910 | 200 x 3 | 10 m | 4,32 |

DÖNÜŞ ELEMANLARI

Return Components - Accessories



GÖVDE

Body

ISI DAYANIMI

Heat Resistance

DARBE DAYANIMI

Impact Resistance

HAMMADDE

Raw Material

KALİTE STANDARDI

Quality Certificate

S / 40 PVC (CH2 - CH2) PVC

S / 40 PVC (CH2 - CH2) PVC

70 °C Aleve Karşı Kendinden Sönme Özelliği

70 °C Halogen Free Not Flammable

83-85 Sh Noktasal Ağırlık Kapasitesi 120 kg (1m)

83-85 Sh Point Weight Capacity 120 kg (for 1m)

S / 40 PVC

S / 40 PVC



Özel ve sarı renkli ürünler için lütfen fiyat sorunuz.

Please Ask Prices For Special and Yellow Colours.

| ÜRÜN KODU Product Code | AÇIKLAMA Details | AĞIRLIK Weight (kg) | ÖLÇÜLER Dimensions (mm) | AMBALAJ Package | FİYAT Prices (\$) |
|---------------------------|-----------------------------------------|------------------------|----------------------------|--------------------|----------------------|
| YPC2410 YD | Yatay Dönüş Horizontal Return | 0.140 | 100 x 165 x 50 x 3 | 10 Adet | 2,81 |
| YPC2415 YD | Yatay Dönüş Horizontal Return | 0.280 | 150 x 230 x 70 x 3 | 10 Adet | 3,80 |
| YPC2420 YD | Yatay Dönüş Horizontal Return | 0.530 | 200 x 290 x 100 x 3 | 10 Adet | 5,55 |
| YPC2410 YDK | Yatay Dönüş Kapağı Hor. Return Cover | - | - | 10 Adet | 0,65 |
| YPC2415 YDK | Yatay Dönüş Kapağı Hor. Return Cover | - | - | 10 Adet | 1,75 |
| YPC2420 YDK | Yatay Dönüş Kapağı Hor. Return Cover | - | - | 10 Adet | 1,50 |
| YPC2410 TD | T Dönüş T Return | 0.188 | 100 x 220 x 50 x 3 | 10 Adet | 3,92 |
| YPC2415 TD | T Dönüş T Return | 0.360 | 150 x 290 x 70 x 3 | 10 Adet | 4,92 |
| YPC2420 TD | T Dönüş T Return | 0.580 | 200 x 340 x 100 x 3 | 10 Adet | 6,22 |
| YPC2410 TDK | T Kapak T Cover | - | - | 10 Adet | 0,60 |
| YPC2415 TDK | T Kapak T Cover | - | - | 10 Adet | 1,50 |
| YPC2420 TDK | T Kapak T Cover | - | - | 10 Adet | 2,00 |

DÖNÜŞ ELEMANLARI

Return Components - Accessories



GÖVDE

Body

ISI DAYANIMI

Heat Resistance

DARBE DAYANIMI

Impact Resistance

HAMMADDE

Raw Material

KALİTE STANDARDI

Quality Certificate

S / 40 PVC (CH2 - CH2) PVC

S / 40 PVC (CH2 - CH2) PVC

70 °C Alev Karşı Kendinden Sönme Özelliği

70 °C Halogen Free Not Flammable

83-85 Sh Noktasal Ağırlık Kapasitesi 120 kg (1m)

83-85 Sh Point Weight Capacity 120 kg (for 1m)

S / 40 PVC

S / 40 PVC



Özel ve sarı renkli ürünler için lütfen fiyat sorunuz.

Please Ask Prices For Special and Yellow Colours.

| ÜRÜN KODU Product Code | AÇIKLAMA Details | AĞIRLIK Weight (kg) | ÖLÇÜLER Dimensions (mm) | AMBALAJ Package | FİYAT Prices (\$) |
|---------------------------|-----------------------------------|------------------------|----------------------------|--------------------|----------------------|
| YPC2410 DB | 4'lü Bağlantı 4 Way Connection | 0.210 | 100 x 220 x 50 x 3 | 10 Adet | 4,55 |
| YPC2415 DB | 4'lü Bağlantı 4 Way Connection | 0.400 | 150 x 290 x 70 x 3 | 10 Adet | 6,10 |
| YPC2420 DB | 4'lü Bağlantı 4 Way Connection | 0.600 | 200 x 340 x 100 x 3 | 10 Adet | 6,60 |
| YPC2410 DB-K | Kapak Cover | - | - | 10 Adet | 0,92 |
| YPC2415 DB-K | Kapak Cover | - | - | 10 Adet | 1,46 |
| YPC2420 DB-K | Kapak Cover | - | - | 10 Adet | 2,10 |
| YPC2410 İÇB | İç Bükey Inner Souterbend | - | 100 x 95 x 50 x 3 | 10 Adet | 1,25 |
| YPC2415 İÇB | İç Bükey Inner Souterbend | - | 150 x 130 x 70 x 3 | 10 Adet | 1,42 |
| YPC2420 İÇB | İç Bükey Inner Souterbend | - | 200 x 180 x 100 x 3 | 10 Adet | 2,51 |
| YPC2410 DİB | Dış Bükey Outer Souterbend | - | 100 x 95 x 3 | 10 Adet | 1,25 |
| YPC2415 DİB | Dış Bükey Outer Souterbend | - | 150 x 130 x 3 | 10 Adet | 1,42 |
| YPC2420 DİB | Dış Bükey Outer Souterbend | - | 200 x 180 x 3 | 10 Adet | 2,51 |

REDÜKSİYON - EK - İÇ - DIŞ BÜKEYLER

Reduction Connection Components - Accessories



GÖVDE

Body

ISI DAYANIMI

Heat Resistance

DARBE DAYANIMI

Impact Resistance

HAMMADDE

Raw Material

KALİTE STANDARDI

Quality Certificate

S / 40 PVC (CH2 - CH2) PVC

S / 40 PVC (CH2 - CH2) PVC

70 °C Alev Karşı Kendinden Sönme Özelliği

70 °C Halogen Free Not Flammable

83-85 Sh Noktasal Ağırlık Kapasitesi 120 kg (1m)

83-85 Sh Point Weight Capacity 120 kg (for 1m)

S / 40 PVC

S / 40 PVC



Özel ve sarı renkli ürünler için lütfen fiyat sorunuz.

Please Ask Prices For Special and Yellow Colours.

| ÜRÜN KODU Product Code | AÇIKLAMA Details | AĞIRLIK Weight (kg) | ÖLÇÜLER Dimensions (mm) | AMBALAJ Package | FİYAT Prices (\$) |
|---------------------------|-----------------------------------------|------------------------|----------------------------|--------------------|----------------------|
| YPC2410 RD | Redüksiyon Reduction | 0.145 | 100-150 x 160 x 50 x 3 | 10 Adet | 4,55 |
| YPC2415 RD | Redüksiyon Reduction | 0.285 | 200-150 x 225 x 70 x 3 | 10 Adet | 6,10 |
| YPC2410 RD-K | Redüksiyon Kapağı Reduction Cover | - | 200-100 x 160 x 3 | 10 Adet | 0,66 |
| YPC2415 RD-K | Redüksiyon Kapağı Reduction Cover | - | 200-150 x 225 x 3 | 10 Adet | 1,16 |
| YPC2410 EK | Birleştirme Elemanı Connection Comp. | 0.080 | - | 10 Adet | 0,80 |
| YPC2415 EK | Birleştirme Elemanı Connection Comp. | 0.155 | - | 10 Adet | 1,40 |
| YPC2420 EK | Birleştirme Elemanı Connection Comp. | 0.240 | - | 10 Adet | 2,00 |
| YPC2410 İÇBK | İç Bükey Kapak Inner Souterbend | - | - | 10 Adet | 0,54 |
| YPC2415 İÇBK | İç Bükey Kapak Inner Souterbend | - | - | 10 Adet | 0,76 |
| YPC2420 İÇBK | İç Bükey Kapak Inner Souterbend | - | - | 10 Adet | 1,20 |
| YPC2410 DIBK | Diş Bükey Kapak Outer Souterbend | - | - | 10 Adet | 0,60 |
| YPC2415 DIBK | Diş Bükey Kapak Outer Souterbend | - | - | 10 Adet | 1,66 |
| YPC2420 DIBK | Diş Bükey Kapak Outer Souterbend | - | - | 10 Adet | 2,63 |

TAŞIMA PARÇALARI

Carrier Parts



GÖVDE

Body

ISI DAYANIMI

Heat Resistance

DARBE DAYANIMI

Impact Resistance

HAMMADDE

Raw Material

KALİTE STANDARDI

Quality Certificate

S / 40 PVC (CH2 - CH2) PVC

S / 40 PVC (CH2 - CH2) PVC

70 °C Alev Karşı Kendinden Sönme Özelliği

70 °C Halogen Free Not Flammable

83-85 Sh Noktasal Ağırlık Kapasitesi 120 kg (1m)

83-85 Sh Point Weight Capacity 120 kg (for 1m)

S / 40 PVC

S / 40 PVC



Özel ve sarı renkli ürünler için lütfen fiyat sorunuz.

Please Ask Prices For Special and Yellow Colours.

| ÜRÜN KODU Product Code | AÇIKLAMA Details | AĞIRLIK Weight (kg) | ÖLÇÜLER Dimensions (mm) | AMBALAJ Package | FİYAT Prices (\$) |
|---------------------------|---------------------------------|------------------------|----------------------------|--------------------|----------------------|
| YPC2410 AT | Aski Taşıyıcı Hanger Carrier | 0.050 | 100'lük Taşıyıcı | 10 Adet | 0,71 |
| YPC2415 AT | Aski Taşıyıcı Hanger Carrier | 0.105 | 150'lük Taşıyıcı | 10 Adet | 0,92 |
| YPC2420 AT | Aski Taşıyıcı Hanger Carrier | 0.190 | 200'lük Taşıyıcı | 10 Adet | 1,46 |

TAŞIMA PARÇALARI - VİDA VE SOMUNLAR

Carrier Parts - Screw and Nuts



| ÜRÜN KODU Product Code | AÇIKLAMA Details | AĞIRLIK Weight (kg) | ÖLÇÜLER Dimensions (mm) | AMBALAJ Package | FİYAT Prices (\$) |
|---------------------------|-------------------------------------------|------------------------|----------------------------|--------------------|----------------------|
| YPC2410 DT | Duvar Taşıyıcı Wall Carrier | 0.240 | 100 x 100 | 10 Adet | 1,50 |
| YPC2415 DT | Duvar Taşıyıcı Wall Carrier | 0.320 | 160 x 100 | 10 Adet | 2,00 |
| YPC2420 DT | Duvar Taşıyıcı Wall Carrier | 0.420 | 210 x 100 | 10 Adet | 2,50 |
| YPC2410 CT | C Tip Taşıyıcı C Type Carrier | 0.216 | 100'lük Taşıyıcı | 10 Adet | 1,50 |
| YPC2415 CT | C Tip Taşıyıcı C Type Carrier | 0.262 | 150'lük Taşıyıcı | 10 Adet | 2,00 |
| YPC2420 CT | C Tip Taşıyıcı C Type Carrier | 0.328 | 200'lük Taşıyıcı | 10 Adet | 2,50 |
| YPC 01 UT | Üstten Asmalı Taşıyıcı U Type Rod | 0.298 | 100-150-200'lük | 10 Adet | 1,81 |
| YPC 8*1000 | Tij Taşıyıcı Threaded Rod | 0.298 | 1000 | 10 Adet | 1,50 |
| YPC 8*2000 | Tij Taşıyıcı Threaded Rod | 0.596 | 2000 | 10 Adet | 3,00 |
| YPC 10*1000 | Tij Taşıyıcı Threaded Rod | 0.400 | 1000 | 10 Adet | 3,00 |
| YPC 10*2000 | Tij Taşıyıcı Threaded Rod | 0.800 | 2000 | 10 Adet | 6,00 |
| YPC 01 | Dübel - Vida - Somun Peg - Screw - Nut | 0.012 | M8 Çakmaklı Tip | - | 0,22 |
| YPC 02 | Dübel - Vida - Somun Peg - Screw - Nut | 0.014 | M8 Çekmeli Tip | - | 0,35 |
| YPC 03 | Dübel - Vida - Somun Peg - Screw - Nut | 0.120 | M8 Somun | - | 0,04 |
| YPC 04 | Dübel - Vida - Somun Peg - Screw - Nut | 0.210 | M10 Somun | - | 0,90 |
| YPC 05 | Dübel - Vida - Somun Peg - Screw - Nut | 0.010 | Bağlantı Civa Takımı | - | 0,27 |

TABAN SAÇLI POLYESTER PANOLAR





POLYESTER PANO
POLYESTER ENCLOSURES



2016
COLLECTION

TABAN SACLI POLYESTER PANOLAR

Polyester Enclosures



PLY 222



GÖVDE

Body

CONTA

Gasket

KULLANIM ALANI

Application

KİMYASAL DAYANIMI

Chemical Resistance

ISI DAYANIMI

Heating Strength

AŞINMA DAYANIMI

Wear Strength

UYGULAMA

Technical Application

CTP Cam Elyaf Takviyeli Polyester

GRP

Poliüretan Dökme Conta

Polyurethane Foam Gasket

Dahili ve Harici Uygulamalara Uygundur

Indoor & Outdoor

Asit ve Bazlara Karşı Tam Koruma

Full Resistance for Acid and Chemical Bases

-40° / +140 °C

Olumsuz Hava Koşullarına Karşı Yüksek Dayanım

High Strength for Negative Air Condition

Sıva Üstü

Surface Mounted



PLY 270



PLY 271



PLY 272



PLY 273



| ÜRÜN KODU Product Code | AÇIKLAMA Description | AĞIRLIK Weight (kg) | ÖLÇÜLER Dimensions (mm) | KOLİ AD. Pcs / Ctn | FIYAT Prices (TL) |
|---------------------------|---------------------------------------------------------------------|------------------------|----------------------------|-----------------------|----------------------|
| PLY 222 | Taban Saclı Polyester Pano Polyester Panel Board With Back Plate | 2,91 | 200 x 300 x 130 | 1 | 47,00 |
| PLY 223 | Taban Saclı Polyester Pano Polyester Panel Board With Back Plate | 4,97 | 300 x 400 x 150 | 1 | 70,00 |
| PLY 224 | Taban Saclı Polyester Pano Polyester Panel Board With Back Plate | 7,85 | 350 x 500 x 170 | 1 | 100,00 |
| PLY 225 | Taban Saclı Polyester Pano Polyester Panel Board With Back Plate | 10,65 | 400 x 600 x 220 | 1 | 115,00 |
| PLY 226 | Taban Saclı Polyester Pano Polyester Panel Board With Back Plate | 16,45 | 500 x 700 x 240 | 1 | 225,00 |
| PLY 227 | Taban Saclı Polyester Pano Polyester Panel Board With Back Plate | 20,24 | 600 x 800 x 260 | 1 | 290,00 |
| PLY 270 | Taban Saclı Polyester Pano Polyester Panel Board With Back Plate | 47,00 | 700 x 1100 x 350 | 1 | 900,00 |
| PLY 271 | Taban Saclı Polyester Pano Polyester Panel Board With Back Plate | 48,00 | 700 x 1100 x 350 | 1 | 1.000,00 |
| PLY 272 | Taban Saclı Polyester Pano Polyester Panel Board With Back Plate | 94,00 | 1400 x 1100 x 350 | 1 | 1.850,00 |
| PLY 273 | Taban Saclı Polyester Pano Polyester Panel Board With Back Plate | 86,00 | 700 x 2100 x 350 | 1 | 1.850,00 |

POLYESTER SAYAÇ PANOLARI

Polyester Meter Enclosures



PLY 218

GÖVDE

Body

CONTA

Gasket

KULLANIM ALANI

Application

KİMYASAL DAYANIMI

Chemical Resistance

ISI DAYANIMI

Heating Strength

AŞINMA DAYANIMI

Wear Strength

UYGULAMA

Technical Application

CTP Cam Elyaf Takviyeli Polyester
GRP

Polüüretan Dökme Conta

Polyurethane Foam Gasket

Dahili ve Harici Uygulamalara Uygunur
Indoor & Outdoor

Asit ve Bazlara Karşı Tam Koruma
Full Resistance for Acit and Chemical Bases

-40⁰ / +140 °C

Olumsuz Hava Koşullarına Karşı Yüksek Dayanım
High Strength for Negative Air Condition

Sıva Üstü

Surface Mounted



PLY 219



PLY 220



| ÜRÜN KODU Product Code | AÇIKLAMA Description | AĞIRLIK Weight (kg) | ÖLÇÜLER Dimensions (mm) | KOLİ AD. Pcs / Ctn | FIYAT Prices (TL) |
|---------------------------|---------------------------------------------------|------------------------|----------------------------|-----------------------|----------------------|
| PLY 218 | Monofaze Sayaç Panosu Single Phase Meter Panel | 3,21 | 200 x 300 x 130 | 1 | 61,00 |
| PLY 219 | Trifaze Sayaç Panosu Three - Phase Meter Panel | 5,50 | 300 x 400 x 150 | 1 | 91,00 |
| PLY 220 | Trifaze Sayaç Panosu Three - Phase Meter Panel | 4,40 | 350 X 500 X 170 | 1 | 130,00 |
| PLY 221 | X5 Kombi Sayaç Panosu X5 Combi Meter Panel | 11,30 | 400 x 600 x 220 | 1 | 149,00 |

OPAK KAPAKLI TABAN SACLI

PLASTİK PANO





ABS - PC PANOLAR

ABS - POLYCARBONATE ENCLOSURES



2016
COLLECTION

OPAK KAPAKLI TABAN SAÇLI PANOLAR

Coloured Cover Enclosures



POLİ 022

GÖVDE

Body

CONTA

Gasket

KULLANIM ALANI

Functionality

KİMYASAL DAYANIMI

Chemical Resistance

ISI DAYANIMI

Heating Strength

AŞINMA DAYANIMI

Wear Strength

UYGULAMA

Technical Application

ABS - PC

ABS - PC

Poliüretan Dökme Conta

Polyurethane Foam Gasket

Dahili ve Harici Uygulamalara Uygundur

Indoor & Outdoor

Asit ve Bazlara Karşı Tam Koruma

Full Resistance for Acid and Chemical Bases

-25° / +60 °C

Olumsuz Hava Koşullarına Karşı Yüksek Dayanım

High Strength for Negative Air Condition

Sıva Üstü

Surface Mounted



POLİ 018



POLİ 019



POLİ 023



| ÜRÜN KODU Product Code | AÇIKLAMA Description | AĞIRLIK Weight (kg) | ÖLÇÜLER Dimensions (mm) | KOLİ AD. Pcs / Ctn | FİYAT Prices (TL) |
|---------------------------|-------------------------------------|------------------------|----------------------------|-----------------------|----------------------|
| POLİ 018 | Taban Saçlı Pano With Back Plate | 1,95 | 235 x 435 x 110 | 10 | 45,00 |
| POLİ 019 | Taban Saçlı Pano With Back Plate | 3,80 | 355 x 560 x 135 | 5 | 78,00 |
| POLİ 022 | Taban Saçlı Pano With Back Plate | 1,89 | 250 x 300 x 145 | 10 | 45,00 |
| POLİ 023 | Taban Saçlı Pano With Back Plate | 2,92 | 300 x 400 x 165 | 5 | 60,00 |

OPAK KAPAKLI TABAN SAÇLI PANOLAR

Coloured Cover Enclosures



POLİ 024

GÖVDE

Body

CONTA

Gasket

KULLANIM ALANI

Functionality

KİMYASAL DAYANIMI

Chemical Resistance

ISI DAYANIMI

Heating Strength

AŞINMA DAYANIMI

Wear Strength

UYGULAMA

Technical Application

ABS - PC

ABS - PC

Poliüretan Dökme Conta

Polyurethane Foam Gasket

Dahili ve Harici Uygulamalara Uygun

Indoor & Outdoor

Asit ve Bazlara Karşı Tam Koruma

Full Resistance for Acid and Chemical Bases

-25° / +60 °C

Olumsuz Hava Koşullarına Karşı Yüksek Dayanım

High Strength for Negative Air Condition

Sıva Üstü

Surface Mounted



POLİ 025



POLİ 046



POLİ 068



| ÜRÜN KODU Product Code | AÇIKLAMA Description | AĞIRLIK Weight (kg) | ÖLÇÜLER Dimensions (mm) | KOLİ AD. Pcs / Ctn | FİYAT Prices (TL) |
|---------------------------|-------------------------------------|------------------------|----------------------------|-----------------------|----------------------|
| POLİ 024 | Taban Saçlı Pano With Back Plate | 5,00 | 400 x 500 x 190 | 5 | 100,00 |
| POLİ 025 | Taban Saçlı Pano With Back Plate | 8,81 | 500 x 700 x 220 | 2 | 210,00 |
| POLİ 046 | Taban Saçlı Pano With Back Plate | 6,00 | 400 x 600 x 240 | 4 | 110,00 |
| POLİ 068 | Taban Saçlı Pano With Back Plate | 12,15 | 600 x 800 x 260 | 1 | 390,00 |

ŞEFFAF KAPAKLI TABAN SAÇLI PANOLAR

Transparent Cover Boxes With Inner Plate



POLİ 026

GÖVDE

Body

CONTA

Gasket

KULLANIM ALANI

Functionality

KİMYASAL DAYANIMI

Chemical Resistance

ISI DAYANIMI

Heating Strength

AŞINMA DAYANIMI

Wear Strength

UYGULAMA

Technical Application

ABS - PC

ABS - PC

Polüretan Dökme Conta

Polyurethane Foam Gasket

Dahili ve Harici Uygulamalara Uygun

Indoor & Outdoor

Asit ve Bazlara Karşı Tam Koruma

Full Resistance for Acid and Chemical Bases

-25° / +60 °C

Olumsuz Hava Koşullarına Karşı Yüksek Dayanım

High Strength for Negative Air Condition

Sıva Üstü

Surface Mounted



POLİ 021



POLİ 020



POLİ 027



| ÜRÜN KODU Product Code | AÇIKLAMA Description | AĞIRLIK Weight (kg) | ÖLÇÜLER Dimensions (mm) | KOLİ AD. Pcs / Ctn | FİYAT Prices (TL) |
|---------------------------|-------------------------------------|------------------------|----------------------------|-----------------------|----------------------|
| POLİ 020 | Taban Saçlı Pano With Back Plate | 1,95 | 235 x 435 x 110 | 10 | 45,00 |
| POLİ 021 | Taban Saçlı Pano With Back Plate | 3,83 | 355 x 560 x 135 | 5 | 78,00 |
| POLİ 026 | Taban Saçlı Pano With Back Plate | 2,00 | 250 x 300 x 145 | 10 | 55,00 |
| POLİ 027 | Taban Saçlı Pano With Back Plate | 3,13 | 300 x 400 x 165 | 5 | 69,00 |

ŞEFFAF KAPAKLI TABAN SAÇLI PANOLAR

Transparent Cover Boxes With Inner Plate



POLİ 029

GÖVDE

Body

CONTA

Gasket

KULLANIM ALANI

Functionality

KİMYASAL DAYANIMI

Chemical Resistance

ISI DAYANIMI

Heating Strength

AŞINMA DAYANIMI

Wear Strength

UYGULAMA

Technical Application

ABS - PC

ABS - PC

Poliüretan Dökme Conta

Polyurethane Foam Gasket

Dahili ve Harici Uygulamalara Uygun

Indoor & Outdoor

Asit ve Bazlara Karşı Tam Koruma

Full Resistance for Acid and Chemical Bases

-25° / +60 °C

Olumsuz Hava Koşullarına Karşı Yüksek Dayanım

High Strength for Negative Air Condition

Sıva Üstü

Surface Mounted



POLİ 028



POLİ 034



POLİ 047



| ÜRÜN KODU Product Code | AÇIKLAMA Description | AĞIRLIK Weight (kg) | ÖLÇÜLER Dimensions (mm) | KOLİ AD. Pcs / Ctn | FİYAT Prices (TL) |
|---------------------------|-------------------------------------|------------------------|----------------------------|-----------------------|----------------------|
| POLİ 028 | Taban Saçlı Pano With Back Plate | 5,20 | 400 x 500 x 190 | 5 | 124,00 |
| POLİ 029 | Taban Saçlı Pano With Back Plate | 9,20 | 500 x 700 x 220 | 2 | 275,00 |
| POLİ 034 | Taban Saçlı Pano With Back Plate | 1,67 | 250 x 375 x 112 | 10 | 30,00 |
| POLİ 047 | Taban Saçlı Pano With Back Plate | 6,25 | 400 x 600 x 240 | 4 | 128,00 |
| POLİ 069 | Taban Saçlı Pano With Back Plate | 12,74 | 600 x 800 x 260 | 1 | 420,00 |

SIVA ÜSTÜ W OTOMAT KUTULARI

Surface Mounted MCB Boxes



POLİ 007

GÖVDE

Body

CONTA

Gasket

KULLANIM ALANI

Functionality

KİMYASAL DAYANIMI

Chemical Resistance

ISI DAYANIMI

Heating Strength

AŞINMA DAYANIMI

Wear Strength

UYGULAMA

Technical Application

ABS - PC

ABS - PC

Polüüretan Dökme Conta

Polyurethane Foam Gasket

Dahili ve Harici Uygulamalara Uygun

Indoor & Outdoor

Asit ve Bazlara Karşı Tam Koruma

Full Resistance for Acid and Chemical Bases

-25° / +60 °C

Olumsuz Hava Koşullarına Karşı Yüksek Dayanım

High Strength for Negative Air Condition

Sıva Üstü

Surface Mounted



POLİ 006



POLİ 011



POLİ 012



| ÜRÜN KODU Product Code | AÇIKLAMA Description | AĞIRLIK Weight (kg) | ÖLÇÜLER Dimensions (mm) | KOLİ AD. Pcs / Ctn | FİYAT Prices (TL) |
|---------------------------|----------------------------------------------------------------------------|------------------------|----------------------------|-----------------------|----------------------|
| POLİ 007 | 12 W Otomat Kapasiteli 12 Mod. MCB Capacity | 0,97 | 280 x 220 x 130 | 5 | 17,50 |
| POLİ 011 | 18 W Otomat - Bara Giriş Bölmeli 18 Mod. MCB. Cap. Busbar Entry Section | 1,71 | 235 x 435 x 110 | 10 | 45,00 |
| POLİ 012 | 36 W Otomat - Bara Giriş Bölmeli 36 Mod. MCB. Cap. Busbar Entry Section | 3,50 | 355 x 560 x 135 | 5 | 78,00 |
| POLİ 006 | 12 W Otomat Kapasiteli 12 Mod. MCB Capacity | 0,33 | 150 x 211 x 100 | 1 | 7,50 |

SIVA ALTI W OTOMAT KUTULARI

Recessed Mounted MCB Boxes



POLİ 009

GÖVDE

Body

CONTA

Gasket

KULLANIM ALANI

Functionality

KİMYASAL DAYANIMI

Chemical Resistance

ISI DAYANIMI

Heating Strength

AŞINMA DAYANIMI

Wear Strength

UYGULAMA

Technical Application

ABS - PC

ABS - PC

Polüüretan Dökme Conta

Polyurethane Foam Gasket

Dahili ve Harici Uygulamalara Uygun

Indoor & Outdoor

Asit ve Bazlara Karşı Tam Koruma

Full Resistance for Acid and Chemical Bases

-25° / +60 °C

Olumsuz Hava Koşullarına Karşı Yüksek Dayanım

High Strength for Negative Air Condition

Sıva Üstü

Surface Mounted



POLİ 013-1



POLİ 013



POLİ 014



POLİ 015



| ÜRÜN KODU Product Code | AÇIKLAMA Description | AĞIRLIK Weight (kg) | ÖLÇÜLER Dimensions (mm) | KOLİ AD. Pcs / Ctn | FİYAT Prices (TL) |
|---------------------------|--------------------------------------------------|------------------------|----------------------------|-----------------------|----------------------|
| POLİ 009 | 20 W Otomat Kapasiteli 20 Module MCB Capacity | 1,43 | 375 x 250 x 122 | 10 | 30,00 |
| POLİ 013 | 12 W Otomat Kapasiteli 12 Module MCB Capacity | 0,90 | 290 x 211 x 100 | 22 | 16,00 |
| POLİ 013-1 | 15 W Otomat Kapasiteli 15 Module MCB Capacity | 1,17 | 281 x 201 x 90 | 10 | 21,00 |
| POLİ 014 | 24 W Otomat Kapasiteli 24 Module MCB Capacity | 1,56 | 290 x 386 x 100 | 1 | 32,00 |
| POLİ 015 | 36 W Otomat Kapasiteli 36 Module MCB Capacity | 2,35 | 290 x 561 x 100 | 1 | 48,00 |

SIVA ÜSTÜ SAYAÇ VE DAĞITIM PANOLARI

Surface Mounted Meter and Distribution Boxes



POLİ 016

GÖVDE

Body

CONTA

Gasket

KULLANIM ALANI

Functionality

KİMYASAL DAYANIMI

Chemical Resistance

ISI DAYANIMI

Heating Strength

AŞINMA DAYANIMI

Wear Strength

UYGULAMA

Technical Application

ABS - PC

ABS - PC

Polüretan Dökme Conta

Polyurethane Foam Gasket

Dahili ve Harici Uygulamalara Uygundur

Indoor & Outdoor

Asit ve Bazlara Karşı Tam Koruma

Full Resistance for Acid and Chemical Bases

-25⁰ / +60 °C

Olumsuz Hava Koşullarına Karşı Yüksek Dayanım

High Strength for Negative Air Condition

Sıva Üstü

Surface Mounted



POLİ 101 / S. A. - R. M.



POLİ 017



POLİ 038



POLİ 038-1



ÜRÜN KODU

Product Code

AÇIKLAMA

Description

AĞIRLIK

Weight (kg)

ÖLÇÜLER

Dimensions (mm)

KOLİ AD.

Pcs / Ctn

FİYAT

Prices (TL)

| | | | | | |
|-----------------|----------------------------------------------------------------------------------------------------------------------------|------|-----------------|----|-------|
| POLİ 101 / S.A. | Monofaze / Trifaze Sıva Altı Sayaç Panosu - Şeffaf Kapak Monophase / Triphase Flush Mount Meter Box - Transparent Cover | 1,32 | 250 x 375 x 122 | 10 | 30,00 |
| POLİ 016 | Monofaze Sayaç 9 Sigorta Kapasiteli - Şeffaf Kapak Monophase Meter With 9 Single Mcb Capacity - Transparent Cover | 1,70 | 235 x 435 x 110 | 10 | 45,00 |
| POLİ 017 | Trifaze Sayaç 12 Sigorta Kapasiteli - Şeffaf Kapak Triphase Meter With 12 Single Mcb Capacity - Transparent Cover | 3,50 | 355 x 565 x 135 | 5 | 78,00 |
| POLİ 038 | Monofaze Sayaç 6 Sigorta Kapasiteli - Opak Kapak Monophase Meter With 6 Single Mcb Capacity - Coloured Cover | 2,06 | 350 x 300 x 145 | 10 | 65,00 |
| POLİ 038-1 | Monofaze Sayaç 15 Sigorta Kapasiteli - Opak Kapak Monophase Meter With 15 Single Mcb Capacity - Coloured Cover | 3,80 | 300 x 400 x 165 | 5 | 85,00 |

SIVA ÜSTÜ SAYAÇ VE DAĞITIM PANOLARI

Surface Mounted Meter and Distribution Boxes



POLİ 039

GÖVDE

Body

CONTA

Gasket

KULLANIM ALANI

Functionality

KİMYASAL DAYANIMI

Chemical Resistance

ISI DAYANIMI

Heating Strength

AŞINMA DAYANIMI

Wear Strength

UYGULAMA

Technical Application

ABS - PC

ABS - PC

Poliüretan Dökme Conta

Polyurethane Foam Gasket

Dahili ve Harici Uygulamalara Uygun

Indoor & Outdoor

Asit ve Bazlara Karşı Tam Koruma

Full Resistance for Acid and Chemical Bases

-25° / +60 °C

Olumsuz Hava Koşullarına Karşı Yüksek Dayanım

High Strength for Negative Air Condition

Sıva Üstü

Surface Mounted



POLİ 040



POLİ 041



POLİ 042



| ÜRÜN KODU Product Code | AÇIKLAMA Description | AĞIRLIK Weight (kg) | ÖLÇÜLER Dimensions (mm) | KOLİ AD. Pcs / Ctn | FİYAT Prices (TL) |
|---------------------------|-------------------------------------------------------------------------------------------------------------------------------------------------|------------------------|----------------------------|-----------------------|----------------------|
| POLİ 039 | Trifaze Sayaç 1 Monofaze - 1 Trifaze Priz - 12 Sigorta Kapasiteli Triphase Meter With 1 Monophase - 1 Triphase Socket 12 Single MCB Capacity | 6,25 | 400 x 500 x 195 | 5 | 130,00 |
| POLİ 040 | Trifaze Sayaç 23 Sigorta Kapasiteli Triphase Meter 23 Single MCB Capacity | 6,10 | 400 x 500 x 195 | 5 | 130,00 |
| POLİ 041 | Trifaze Sayaç 30 Sigorta Kapasiteli - Kompakt Şalter Yeri Triphase Meter 30 Single MCB Capacity | 9,70 | 500 x 700 x 220 | 2 | 270,00 |
| POLİ 042 | Trifaze Sayaç - 40 Sigorta Kapasiteli - 4'lü Priz Bölmesi Triphase Meter 40 Single MCB Capacity - 4 Way Socket Section | 9,70 | 500 x 700 x 220 | 2 | 270,00 |

SIVA ÜSTÜ SAYAÇ VE DAĞITIM PANOLARI

Surface Mounted Meter and Distribution Boxes



POLİ 043

GÖVDE

Body

CONTA

Gasket

KULLANIM ALANI

Functionality

KİMYASAL DAYANIMI

Chemical Resistance

ISI DAYANIMI

Heating Strength

AŞINMA DAYANIMI

Wear Strength

UYGULAMA

Technical Application

ABS - PC

ABS - PC

Poliüretan Dökme Conta

Polyurethane Foam Gasket

Dahili ve Harici Uygulamalara Uygun

Indoor & Outdoor

Asit ve Bazlara Karşı Tam Koruma

Full Resistance for Acid and Chemical Bases

-25° / +60 °C

Olumsuz Hava Koşullarına Karşı Yüksek Dayanım

High Strength for Negative Air Condition

Sıva Üstü

Surface Mounted



POLİ 043-Ç



POLİ 045



| ÜRÜN KODU Product Code | AÇIKLAMA Description | AĞIRLIK Weight (kg) | ÖLÇÜLER Dimensions (mm) | KOLİ AD. Pcs / Ctn | FIYAT Prices (TL) |
|---------------------------|---------------------------------------------------------------------------------------------------------------------|------------------------|----------------------------|-----------------------|----------------------|
| POLİ 043 | Trifaze Sayaç - 36 Sigorta Kapasiteli - Kompakt Şalter Yeri Triphase Meter 36 Single Mcb and 1 Pcs MCCB 25A-160A | 9,70 | 500 x 700 x 220 | 2 | 270,00 |
| POLİ 043-Ç | 2 Adet Trifaze Sayaç - 18 Otomat Klemens Yeri Triphase 2 Pcs Meter 18 Single Mcb and Terminal Section | 9,90 | 500 x 700 x 220 | 2 | 270,00 |
| POLİ 045 | X / 5 Sayaç Akım Trafosu + K.A.K.R. - Kompakt Şalter X / 5 Meter Current Transformer - 1 Pcs MCC 160-400A | 12,25 | 500 x 700 x 220 | 2 | 270,00 |

DAHİLİ VE HARİCİ DAĞITIM PANOLARI

Indoor & Outdoor Use Distribution Boxes



GÖVDE

Body

CONTA

Gasket

KULLANIM ALANI

Functionality

KİMYASAL DAYANIMI

Chemical Resistance

ISI DAYANIMI

Heating Strength

AŞINMA DAYANIMI

Wear Strength

UYGULAMA

Technical Application

ABS - PC

ABS - PC

Polüretan Dökme Conta

Polyurethane Foam Gasket

Dahili ve Harici Uygulamalara Uygun

Indoor & Outdoor

Asit ve Bazlara Karşı Tam Koruma

Full Resistance for Acid and Chemical Bases

-25° / +60 °C

Olumsuz Hava Koşullarına Karşı Yüksek Dayanım

High Strength for Negative Air Condition

Sıva Üstü

Surface Mounted



POLİ 053



POLİ 054



POLİ 055



POLİ 056



| ÜRÜN KODU Product Code | AÇIKLAMA Description | AĞIRLIK Weight (kg) | ÖLÇÜLER Dimensions (mm) | KOLİ AD. Pcs / Ctn | FİYAT Prices (TL) |
|---------------------------|-------------------------------------------------------------------------------------------------------------------|------------------------|----------------------------|-----------------------|----------------------|
| POLİ 051 | 40 Sigorta 4'lü Priz Grubu Klemens Bölümü 40 Single MCB - 4 Way Socket and Terminal Section | 9,00 | 500 x 700 x 220 | 2 | 270,00 |
| POLİ 052 | Kompakt Şalter 40 Sigorta Kapasiteli Klemens Bölümü 1 MCCB 63-160A - 40 Single MCB - Terminal Section | 9,00 | 500 x 700 x 220 | 2 | 270,00 |
| POLİ 053 | Kompakt Şalter - 60 Sigorta Kapasiteli 60 Single MCB Capacity | 9,00 | 500 x 700 x 220 | 2 | 270,00 |
| POLİ 054 | 45 Sigorta Kapasiteli - Klemens Bölümü 1 MCCB 25 - 160A - 45 Single MCB - Terminal Section | 9,00 | 500 x 700 x 220 | 2 | 270,00 |
| POLİ 055 | 30 Sigorta Kapasiteli 2'li Priz + Pako Şalter 30 Single MCB Capacity - 2 Socket - Selector Switch | 5,10 | 400 x 500 x 195 | 5 | 130,00 |
| POLİ 056 | 15 Sigorta Kapasiteli - Pako Şalter Klemens Bölümü 15 Single MCB Capacity - Selector Switch - Terminal Section | 5,10 | 400 x 500 x 195 | 5 | 130,00 |

DAHİLİ ve HARİCİ DAĞITIM PANOLARI

Indoor & Outdoor Use Distribution Boxes



POLİ 058

GÖVDE

Body

CONTA

Gasket

KULLANIM ALANI

Functionality

KİMYASAL DAYANIMI

Chemical Resistance

ISI DAYANIMI

Heating Strength

AŞINMA DAYANIMI

Wear Strength

UYGULAMA

Technical Application

ABS - PC

ABS - PC

Poliüretan Dökme Conta

Polyurethane Foam Gasket

Dahili ve Harici Uygulamalara Uygun

Indoor & Outdoor

Asit ve Bazlara Karşı Tam Koruma

Full Resistance for Acid and Chemical Bases

-25° / +60 °C

Olumsuz Hava Koşullarına Karşı Yüksek Dayanım

High Strength for Negative Air Condition

Sıva Üstü

Surface Mounted



POLİ 061



POLİ 062



POLİ 063



POLİ 064



POLİ 057



| ÜRÜN KODU Product Code | AÇIKLAMA Description | AĞIRLIK Weight (kg) | ÖLÇÜLER Dimensions (mm) | KOLİ AD. Pcs / Ctn | FİYAT Prices (TL) |
|---------------------------|-------------------------------------------------------------------------------------|------------------------|----------------------------|-----------------------|----------------------|
| POLİ 057 | 45 Sigorta Kapasiteli 45 Single MCB Capacity | 5,10 | 400 x 500 x 195 | 5 | 130,00 |
| POLİ 058 | 30 Sigorta Kapasiteli - Klemens Bölümü 30 Single MCB Capacity - Terminal Section | 5,10 | 400 x 500 x 195 | 5 | 130,00 |
| POLİ 061 | 30 Sigorta Kapasiteli 30 Single MCB Capacity | 2,85 | 300 x 400 x 165 | 5 | 85,00 |
| POLİ 062 | 20 Sigorta Kapasiteli - Klemens Bölümü 20 Single MCB Capacity - Terminal Section | 2,85 | 300 x 400 x 165 | 5 | 85,00 |
| POLİ 063 | 20 Sigorta Kapasiteli 20 Single MCB Capacity | 2,30 | 250 x 300 x 145 | 10 | 60,00 |
| POLİ 064 | 10 Sigorta Kapasiteli - Klemens Bölümü 10 Single MCB Capacity - Terminal Section | 2,30 | 250 x 300 x 145 | 10 | 60,00 |

DAHİLİ VE HARİCİ DUVAR TİPİ ŞANTİYE PANOLARI

Indoor & Outdoor Type Workshop Boxes



POLİ 037-Ş

GÖVDE

Body

CONTA

Gasket

KULLANIM ALANI

Functionality

KİMYASAL DAYANIMI

Chemical Resistance

ISI DAYANIMI

Heating Strength

AŞINMA DAYANIMI

Wear Strength

UYGULAMA

Technical Application

ABS - PC

ABS - PC

Poliüretan Dökme Conta

Polyurethane Foam Gasket

Dahili ve Harici Uygulamalara Uygundur

Indoor & Outdoor

Asit ve Bazlara Karşı Tam Koruma

Full Resistance for Acit and Chemical Bases

-25° / +60 °C

Olumsuz Hava Koşullarına Karşı Yüksek Dayanım

High Strength for Negative Air Condition

Sıva Üstü

Surface Mounted



POLİ 039-Ş



POLİ 040-Ş



| ÜRÜN KODU Product Code | AÇIKLAMA Description | AĞIRLIK Weight (kg) | ÖLÇÜLER Dimensions (mm) | KOLİ AD. Pcs / Ctn | FIYAT Prices (TL) |
|---------------------------|---------------------------------------------------------------------------------------------------------------------------------------------------|------------------------|----------------------------|-----------------------|----------------------|
| POLİ 037-Ş | Trifaze Sayaç + 32 Sigorta + 4 Adet Priz Kapasiteli Triphase Meter 32 Single MCB Capacity 4 Way Socket Section | 10,30 | 500 x 700 x 220 | 1 | 290,00 |
| POLİ 039-Ş | Trifaze Sayaç 1 Monofaze - 1 Trifaze Priz + 12 Sigorta Kapasiteli Triphase Meter With 1 Monophase - 1 Triphase Socket + 12 Single MCB Capacity | 6,75 | 400 x 500 x 195 | 1 | 150,00 |
| POLİ 040-Ş | Trifaze Sayaç + 23 Sigorta Kapasiteli Triphase Meter 23 Single MCB Capacity | 6,60 | 400 x 500 x 195 | 1 | 150,00 |

HARİCİ TİP AYAKLI ŞANTİYE PANOLARI

Outdoor Type Workshop Boxes



POLİ 035

GÖVDE

Body

CONTA

Gasket

KULLANIM ALANI

Functionality

KİMYASAL DAYANIMI

Chemical Resistance

ISI DAYANIMI

Heating Strength

AŞINMA DAYANIMI

Wear Strength

UYGULAMA

Technical Application

ABS - PC

ABS - PC

Poliüretan Dökme Conta

Polyurethane Foam Gasket

Dahili ve Harici Uygulamalara Uygundur

Indoor & Outdoor

Asit ve Bazlara Karşı Tam Koruma

Full Resistance for Acid and Chemical Bases

-25° / +60 °C

Olumsuz Hava Koşullarına Karşı Yüksek Dayanım

High Strength for Negative Air Condition

Sıva Üstü

Surface Mounted



POLİ 024-Ş1



POLİ 024-Ş3



POLİ 024-Ş4



ÜRÜN KODU

Product Code

AÇIKLAMA

Description

AĞIRLIK

Weight (kg)

ÖLÇÜLER

Dimensions (mm)

KOLİ AD.

Pcs / Ctn

FİYAT

Prices (TL)

| | | | | | |
|-------------|-------------------------------------------------------------------------------------------------------------------------------------------------------------------------|-------|-----------------|--------------------------|--------|
| POLİ 035 | Ayaklı Tip Trifaze Sayaç + 32 Sigorta + Kompakt - 10 Adet Priz Kapasiteli Triphase Meter 32 Single MCB Capacity 1 MCCB 10 Way Socket Section - With Metal Base 26 cm | 14,50 | 500 x 700 x 220 | Tekli Ambalaj Packing | 325,00 |
| POLİ 024-Ş1 | Ayaklı Tip Trifaze Sayaç + 23 Sigorta - 6 Adet Priz Kapasiteli Triphase Meter 23 Single MCB Capacity 6 Way Socket Section - With Metal Base 26 cm | 9,60 | 400 x 500 x 195 | Tekli Ambalaj Packing | 180,00 |
| POLİ 024-Ş3 | Ayaklı Tip Trifaze Sayaç + 12 Sigorta - 1 Monofaze / 1 Trifaze Priz Yeri Triphase Meter 12 Single MCB 2 Way Socket Section - With Metal Base 26 Cm | 8,80 | 400 x 500 x 195 | Tekli Ambalaj Packing | 180,00 |
| POLİ 024-Ş4 | Ayaklı Tip 30 Sigorta + 6 Adet Priz - Klemens Yeri 30 Single MCB Capacity 6 Way Socket and Terminal Section - With Metal Base 26 cm | 9,60 | 400 x 500 x 195 | Tekli Ambalaj Packing | 180,00 |

HARİCİ TİP AYAKLI ŞANTİYE PANOLARI

Outdoor Type Workshop Boxes



POLİ 036

GÖVDE

Body

CONTA

Gasket

KULLANIM ALANI

Functionality

KİMYASAL DAYANIMI

Chemical Resistance

ISI DAYANIMI

Heating Strength

AŞINMA DAYANIMI

Wear Strength

UYGULAMA

Technical Application

ABS - PC

ABS - PC

Poliüretan Dökme Conta

Polyurethane Foam Gasket

Dahili ve Harici Uygulamalara Uygundur

Indoor & Outdoor

Asit ve Bazlara Karşı Tam Koruma

Full Resistance for Acid and Chemical Bases

-25° / +60 °C

Olumsuz Hava Koşullarına Karşı Yüksek Dayanım

High Strength for Negative Air Condition

Zemine Monte

Floor Mounted



POLİ 037



POLİ 096



POLİ 098



| ÜRÜN KODU Product Code | AÇIKLAMA Description | AĞIRLIK Weight (kg) | ÖLÇÜLER Dimensions (mm) | KOLİ AD. Pcs / Ctn | FIYAT Prices (TL) |
|---------------------------|-------------------------------------------------------------------------------------------------------------------------------------------------------------|------------------------|----------------------------|--------------------------|----------------------|
| POLİ 036 | Ayaklı Tip Trifaze Sayaç + 32 Sigorta Kompakt Kapasiteli Triphase Meter 32 Single MCB Capacity 1 MCCB - With Metal Base 26 cm | 13,00 | 500 x 700 x 220 | Tekli Ambalaj Packing | 325,00 |
| POLİ 037 | Ayaklı Tip Trifaze Sayaç + 32 Sigorta - 4 Adet Priz Kapasiteli Triphase Meter 32 Single MCB Capacity 1 MCCB 4 Way Socket Section - With Metal Base 26 cm | 13,00 | 500 x 700 x 220 | Tekli Ambalaj Packing | 325,00 |
| POLİ 096 | Polikarbon Pano Şapkası - Küçük Boy ABS Top Cover - Small Size | 0,45 | 400 x 55 x 210 | Tekli Ambalaj Packing | 23,00 |
| POLİ 097 | Polikarbon Pano Şapkası - Büyük Boy ABS Top Cover - Big Size | 0,60 | 500 x 60 x 240 | Tekli Ambalaj Packing | 35,00 |
| POLİ 098 | Metal Ayak - Küçük Boy 14 cm Metal Base - Small Size 14 cm | 1,60 | 430 x 310 x 140 | Tekli Ambalaj Packing | 45,00 |
| POLİ 099 | Metal Ayak - Büyük Boy 26 cm Metal Base - Small Size 26 cm | 2,70 | 550 x 310 x 260 | Tekli Ambalaj Packing | 55,00 |

KOMBİNASYON KUTULARI

Combination Boxes



POLİ 030

GÖVDE

Body

CONTA

Gasket

KULLANIM ALANI

Functionality

KİMYASAL DAYANIMI

Chemical Resistance

ISI DAYANIMI

Heating Strength

AŞINMA DAYANIMI

Wear Strength

UYGULAMA

Technical Application

ABS - PC

ABS - PC

Poliüretan Dökme Conta

Polyurethane Foam Gasket

Dahili ve Harici Uygulamalara Uygun

Indoor & Outdoor

Asit ve Bazlara Karşı Tam Koruma

Full Resistance for Acid and Chemical Bases

-25° / +60 °C

Olumsuz Hava Koşullarına Karşı Yüksek Dayanım

High Strength for Negative Air Condition

Sıva Üstü

Surface Mounted



POLİ 030-P3



POLİ 031



POLİ 031-P1



POLİ 031-P2



POLİ 031-P3



ÜRÜN KODU

Product Code

AÇIKLAMA

Description

AĞIRLIK

Weight (kg)

ÖLÇÜLER

Dimensions (mm)

KOLİ AD.

Pcs / Ctn

FİYAT

Prices (TL)

| | | | | | |
|-------------|---------------------------------------------------------------------------------------------------------------------------------------|------|-----------------|----|-------|
| POLİ 030 | 9 Sigorta Boş Kombinasyon Kutusu - Büyük Tip Combination Boxes 9 Single MCB Capacity | 0,80 | 220 x 280 x 120 | 5 | 32,00 |
| POLİ 031 | 5 Sigorta Boş Kombinasyon Kutusu - Küçük Tip Combination Boxes 5 Single MCB Capacity | 0,40 | 120 x 220 x 110 | 12 | 15,00 |
| POLİ 031-P1 | 5 Sigorta Kapasiteli 3x25A 1 Adet Priz - Küçük Tip Combination Boxes 5 Single MCB - 1 PCS 3x25A Socket | 0,50 | 120 x 220 x 110 | 10 | 29,00 |
| POLİ 031-P2 | 5 Sigorta 3x25A 1 Adet Priz 1x16A 2 Adet Priz - Küçük Tip Combination Boxes 5 Single MCB - 1 PCS 3x25A Socket - 2 PCS 1x16A Socket | 0,60 | 120 x 220 x 110 | 10 | 38,00 |
| POLİ 031-P3 | 5 Sigorta 1x16A 2 Adet Priz 1x16A 2 Adet Priz Arka - Büyük Tip Combination Boxes 5 Single MCB - 4 PCS 1x16A Socket | 0,56 | 120 x 220 x 110 | 10 | 37,00 |
| POLİ 030-P3 | 9 Sigorta 3x25A 1 Adet Priz 1x16A 4 Adet Priz - Büyük Tip Combination Boxes 9 Single MCB - 1 PCS 3x25A Socket - 4 PCS 1x16A Socket | 1,08 | 220 x 280 x 120 | 4 | 59,00 |

KOMBİNASYON KUTULARI

Combination Boxes



POLİ 030-P4

GÖVDE

Body

CONTA

Gasket

KULLANIM ALANI

Functionality

KİMYASAL DAYANIMI

Chemical Resistance

ISI DAYANIMI

Heating Strength

AŞINMA DAYANIMI

Wear Strength

UYGULAMA

Technical Application

ABS - PC

ABS - PC

Poliüretan Dökme Conta

Polyurethane Foam Gasket

Dahili ve Harici Uygulamalara Uygun

Indoor & Outdoor

Asit ve Bazlara Karşı Tam Koruma

Full Resistance for Acid and Chemical Bases

-25° / +60 °C

Olumsuz Hava Koşullarına Karşı Yüksek Dayanım

High Strength for Negative Air Condition

Sıva Üstü

Surface Mounted



POLİ 030-P5



POLİ 030-P6



POLİ 030-P11



POLİ 030-P13



| ÜRÜN KODU Product Code | AÇIKLAMA Description | AĞIRLIK Weight (kg) | ÖLÇÜLER Dimensions (mm) | KOLİ AD. Pcs / Ctn | FİYAT Prices (TL) |
|---------------------------|-----------------------------------------------------------------------------------------------------------------------------------------------------------------|------------------------|----------------------------|-----------------------|----------------------|
| POLİ 030-P4 | 9 Sigorta 3x25A 2 Adet Priz - Büyük Tip Combination Boxes 9 Single MCB - 2 PCS 3x25A Socket | 1,00 | 220 x 280 x 120 | 5 | 50,00 |
| POLİ 030-P5 | 9 Sigorta 3x25A 2 Adet Priz 1x16A 2 Adet Priz - Büyük Tip Combination Boxes 9 Single MCB - 2 PCS 3x25A Socket - 2 PCS 1x16A Socket | 1,10 | 220 x 280 x 120 | 5 | 64,00 |
| POLİ 030-P6 | 9 Sigorta 3x25A 2 Adet Priz 1x16A 4 Adet Priz - Büyük Tip Combination Boxes 9 Single MCB - 2 PCS 3x25A Socket - 4 PCS 1x16A Socket | 1,20 | 220 x 280 x 120 | 5 | 69,00 |
| POLİ 030-P11 | 9 Sigorta 1x16A 6 Adet Priz 1x16A 2 Adet Priz Yan - Büyük Tip Combination Boxes 9 Single MCB - 8 PCS 1x16A Socket | 1,20 | 220 x 280 x 120 | 5 | 66,00 |
| POLİ 030-P13 | 9 Sigorta 5x32A 1 Adet Priz 3x25A 1 Adet Priz 1x16A 2 Adet Priz - Büyük Tip Combination Boxes 9 Single MCB - Socket: 1 PCS 5x32A / 1 PCS 3x25A / 2 PCS 1x16A | 1,35 | 220 x 280 x 120 | 5 | 70,00 |

TELEFON DAĞITIM PANOLARI

Phone Distribution Boxes



POLİ 085

GÖVDE

Body

CONTA

Gasket

KULLANIM ALANI

Functionality

KİMYASAL DAYANIMI

Chemical Resistance

ISI DAYANIMI

Heating Strength

AŞINMA DAYANIMI

Wear Strength

UYGULAMA

Technical Application

ABS - PC

ABS - PC

Poliüretan Dökme Conta

Polyurethane Foam Gasket

Dahili ve Harici Uygulamalara Uygundur

Indoor & Outdoor

Asit ve Bazlara Karşı Tam Koruma

Full Resistance for Acid and Chemical Bases

-25° / +60 °C

Olumsuz Hava Koşullarına Karşı Yüksek Dayanım

High Strength for Negative Air Condition

Sıva Üstü

Surface Mounted



POLİ 080



POLİ 081



POLİ 082 / S.A.



POLİ 083



POLİ 084



ÜRÜN KODU

Product Code

AÇIKLAMA

Description

AĞIRLIK

Weight (kg)

ÖLÇÜLER

Dimensions (mm)

KOLİ AD.

Pcs / Ctn

FİYAT

Prices (TL)

| | | | | | |
|-----------------|------------------------------------------------------------|------|-----------------|----|-------|
| POLİ 080 | 10-20 Per Arası Sıva Üstü 10-20 Pair Wall Mounted | 0,20 | 85 x 160 x 60 | 5 | 7,20 |
| POLİ 081 | 20-50 Per Arası Sıva Üstü 20-50 Pair Wall Mounted | 0,80 | 220 x 280 x 110 | 6 | 23,50 |
| POLİ 082 / S.A. | 10-100 Per Arası Sıva Altı 10-100 Pair Recessed Mounted | 1,90 | 250 x 375 x 122 | 10 | 38,80 |
| POLİ 083 | 20-100 Per Arası Sıva Üstü 20-100 Pair Wall Mounted | 2,20 | 235 x 435 x 110 | 10 | 63,80 |
| POLİ 084 | 20-100 Per Arası Sıva Üstü 20-100 Pair Wall Mounted | 2,25 | 250 x 300 x 145 | 10 | 48,80 |
| POLİ 085 | 100-150 Per Arası Sıva Üstü 100-150 Pair Wall Mounted | 3,30 | 300 x 400 x 165 | 5 | 68,20 |

TELEFON DAĞITIM PANOLARI

Phone Distribution Boxes



POLİ 090

GÖVDE

Body

CONTA

Gasket

KULLANIM ALANI

Functionality

KİMYASAL DAYANIMI

Chemical Resistance

ISI DAYANIMI

Heating Strength

AŞINMA DAYANIMI

Wear Strength

UYGULAMA

Technical Application

ABS - PC - CTP

ABS - PC - GRP

Poliüretan Dökme Conta

Polyurethane Foam Gasket

Dahili ve Harici Uygulamalara Uygundur

Indoor & Outdoor

Asit ve Bazlara Karşı Tam Koruma

Full Resistance for Acid and Chemical Bases

ABS - PC -25° / +60 °C - CTP/GRP -40° / +140 °C

Olumsuz Hava Koşullarına Karşı Yüksek Dayanım

High Strength for Negative Air Condition

Sıva Üstü

Surface Mounted



POLİ 086



POLİ 087



POLİ 088



POLİ 089



| ÜRÜN KODU Product Code | AÇIKLAMA Description | AĞIRLIK Weight (kg) | ÖLÇÜLER Dimensions (mm) | KOLİ AD. Pcs / Ctn | FİYAT Prices (TL) |
|---------------------------|--------------------------------------------------------------|------------------------|----------------------------|-----------------------|----------------------|
| POLİ 086 | 300 Per Arası Sıva Üstü 300 Pair Wall Mounted | 4,65 | 335 x 560 x 135 | 5 | 116,40 |
| POLİ 087 | 300 Per Arası Sıva Üstü 300 Pair Wall Mounted | 5,75 | 400 x 500 x 195 | 5 | 111,40 |
| POLİ 088 | 400 Per Arası Sıva Üstü 400 Pair Wall Mounted | 7,25 | 400 x 600 x 240 | 4 | 144,00 |
| POLİ 089 | 500 Per Arası Sıva Üstü 500 Pair Wall Mounted | 10,00 | 500 x 700 x 220 | 2 | 253,00 |
| POLİ 090 | 1200-2400 Per Arası Sıva Üstü 1200-2400 Pair Wall Mounted | 35,00 | 700 x 1100 x 350 | 1 | 1.100,00 |
| YPA 040 | Kesmesiz Modül Raglet Non Taglite Krone | - | - | - | 3,40 |

BUAT KUTULARI

Junction Boxes



GÖVDE

Body

ABS - PC

ABS - PC

CONTA

Gasket

Polüretan Dökme Conta

Polyurethane Foam Gasket

KULLANIM ALANI

Functionality

Dahili ve Harici Uygulamalara Uygun

Indoor & Outdoor

KİMYASAL DAYANIMI

Chemical Resistance

Asit ve Bazlara Karşı Tam Koruma

Full Resistance for Acid and Chemical Bases

ISI DAYANIMI

Heating Strength

-25° / +60 °C

AŞINMA DAYANIMI

Wear Strength

Olumsuz Hava Koşullarına Karşı Yüksek Dayanım

High Strength for Negative Air Condition

UYGULAMA

Technical Application

Sıva Üstü

Surface Mounted



| ÜRÜN KODU Product Code | AÇIKLAMA Description | AĞIRLIK Weight (kg) | ÖLÇÜLER Dimensions (mm) | KOLİ AD. Pcs / Ctn | FİYAT Prices (TL) |
|---------------------------|---------------------------------------------------------------------|------------------------|----------------------------|-----------------------|----------------------|
| POLİ 032 | Opak Kapaklı Buat Kutusu Junction Boxes With Opaque Cover | 0,26 | 120 x 220 x 80 | 16 | 8,00 |
| POLİ 032-Ş | Şeffaf Kapaklı Buat Kutusu Junction Boxes With Transparent Cover | 0,27 | 120 x 220 x 80 | 16 | 9,00 |
| POLİ 032-1 | Opak Kapaklı Buat Kutusu Junction Boxes With Opaque Cover | 0,33 | 120 x 220 x 120 | 10 | 10,00 |
| POLİ 033 | Opak Kapaklı Buat Kutusu Junction Boxes With Opaque Cover | 0,64 | 290 x 230 x 100 | 6 | 14,00 |
| POLİ 033-Ş | Şeffaf Kapaklı Buat kutusu Junction Boxes With Transparent Cover | 0,62 | 290 x 230 x 100 | 6 | 14,00 |
| POLİ 101 | Opak Kapaklı Buat Kutusu Junction Boxes With Opaque Cover | 0,12 | 100 x 100 x 50 | 72 | 3,35 |
| POLİ 102 | Opak Kapaklı Buat Kutusu Junction Boxes With Opaque Cover | 0,12 | 120 x 80 x 50 | 90 | 3,35 |
| POLİ 103 | Opak Kapaklı Buat Kutusu Junction Boxes With Opaque Cover | 0,20 | 150 x 110 x 70 | 34 | 6,25 |
| POLİ 104 | Opak Kapaklı Buat Kutusu Junction Boxes With Opaque Cover | 0,42 | 200 x 150 x 80 | 18 | 12,50 |
| POLİ 105 | Opak Kapaklı Buat Kutusu Junction Boxes With Opaque Cover | 0,97 | 300 x 230 x 130 | 4 | 26,80 |