

**YENİ**  
ÜRÜNLERİMİZ

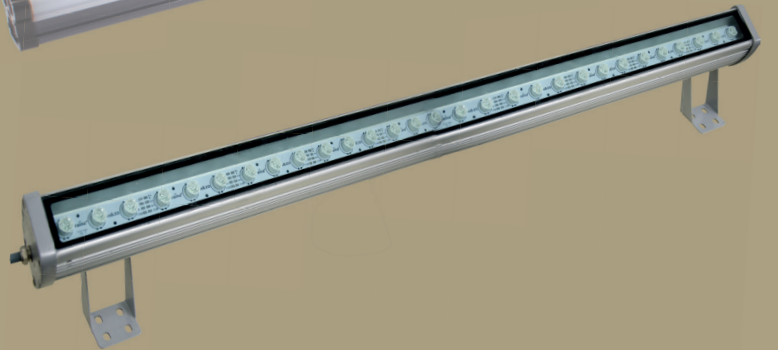

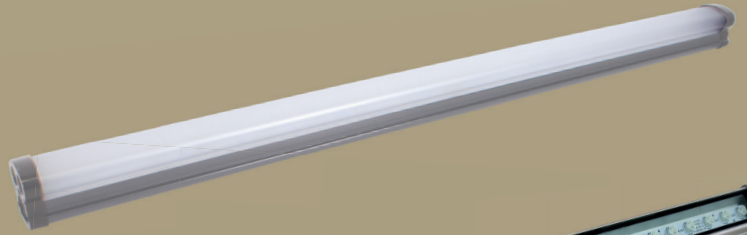
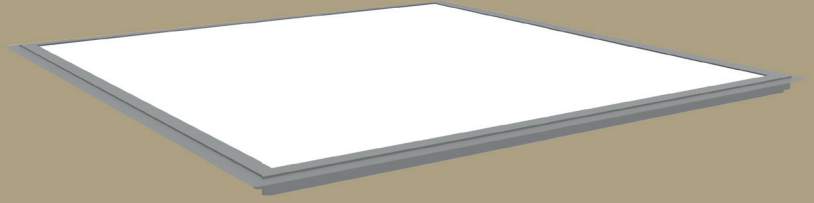
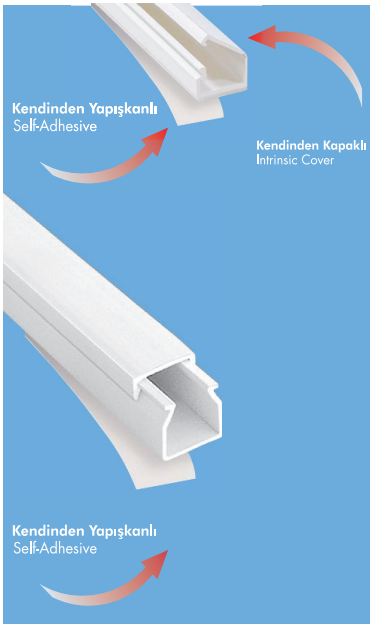
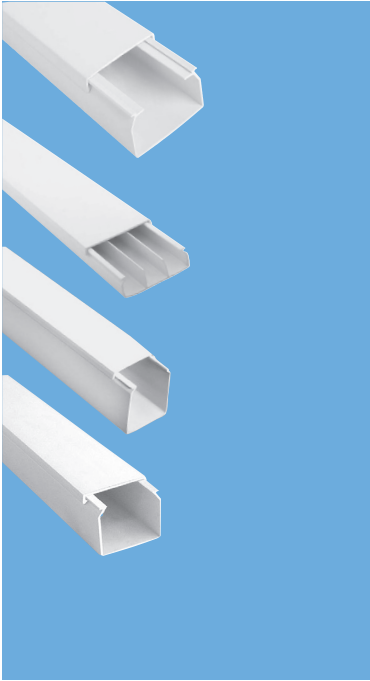
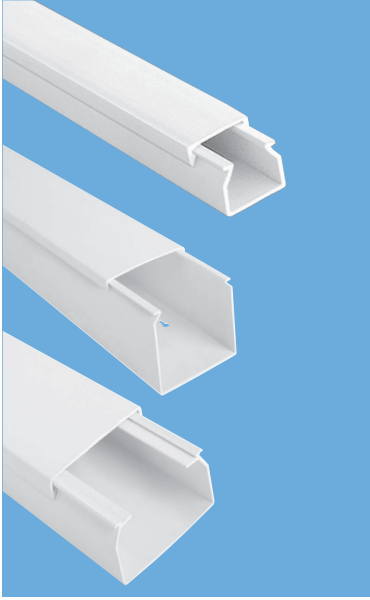

Ürün Kodu	Açıklama / Stok Cinsi	Ambalaj (Kutulu)	Ambalaj Birimi	TL
<b>CANALEX SERİSİ TSE'Lİ KAPALI TİP KABLO KANALLARI (KUTULU)</b>				
001 156 012012 20 00	12X12 MM KABLO KANALI (CANALEX)	250	mt	0,590
001 156 015010 20 00	15X10 MM KABLO KANALI (CANALEX)	250	mt	0,659
001 156 016016 20 00	16X16 MM KABLO KANALI (CANALEX)	250	mt	0,748
001 156 025016 20 00	25X16 MM KABLO KANALI (CANALEX)	150	mt	1,089
001 156 025025 20 00	25X25 MM KABLO KANALI (CANALEX)	100	mt	1,485
001 156 040016 20 00	40X16 MM KABLO KANALI (CANALEX)	100	mt	1,560
001 156 040025 20 00	40X25 MM KABLO KANALI (CANALEX)	80	mt	1,884
001 156 040040 20 00	40X40 MM KABLO KANALI (CANALEX)	50	mt	2,620
001 156 060040 20 00	60X40 MM KABLO KANALI (CANALEX)	40	mt	3,476
001 156 060060 20 00	60X60 MM KABLO KANALI (CANALEX)	32	mt	5,494
001 156 080040 20 00	80X40 MM KABLO KANALI (CANALEX)	30	mt	5,290
001 156 080060 20 00	80X60 MM KABLO KANALI (CANALEX)	24	mt	6,122
001 156 100040 20 00	100X40 MM KABLO KANALI (CANALEX)	24	mt	6,411
001 156 100060 20 00	100X60 MM KABLO KANALI (CANALEX)	20	mt	8,272
<b>CANALEX SERİSİ KAPALI TİP KABLO KANALLARI (KUTULU)(YAPIŞKAN BANTLI)</b>				
001 157 012012 20 00	12X12 KABLO KAN.CANALEX(YPŞB)	250	mt	0,734
001 157 015010 20 00	15X10 KABLO KAN.CANALEX(YPŞB)	230	mt	0,867
001 157 016016 20 00	16X16 KABLO KAN.CANALEX(YPŞB)	230	mt	0,963
001 157 025016 20 00	25X16 KABLO KAN.CANALEX(YPŞB)	150	mt	1,436
001 157 025025 20 00	25X25 KABLO KAN.CANALEX(YPŞB)	100	mt	1,881
001 157 040016 20 00	40X16 KABLO KAN.CANALEX(YPŞB)	100	mt	2,401
001 157 040025 20 00	40X25 KABLO KAN.CANALEX(YPŞB)	80	mt	2,753
001 157 040040 20 00	40X40 KABLO KAN.CANALEX(YPŞB)	50	mt	3,578
001 157 060040 20 00	60X40 KABLO KAN.CANALEX(YPŞB)	40	mt	4,730
<b>EKO SERİSİ TSE'Lİ KAPALI TİP KABLO KANALLARI (KUTULU)</b>				
001 014 010008 20 00	10X08 MM KABLO KANALI-EKO	330	mt.	0,590
001 014 010010 20 00	10X10 MM KABLO KANALI-EKO	330	mt.	0,836
001 014 012012 20 00	12X12 MM KABLO KANALI-EKO	250	mt.	0,638
001 014 015010 20 00	15X10 MM KABLO KANALI-EKO	250	mt.	0,810
001 014 015015 20 00	15X15 MM KABLO KANALI-EKO	250	mt.	0,941
001 014 016016 20 00	16X16 MM KABLO KANALI-EKO	250	mt.	0,944
001 014 020010 20 00	20X10 MM KABLO KANALI-EKO	200	mt.	0,837
001 014 025016 20 00	25X16 MM KABLO KANALI-EKO	150	mt.	1,302
001 014 025025 20 00	25X25 MM KABLO KANALI-EKO	100	mt.	1,650
001 014 025040 20 00	25X40 MM KABLO KANALI-EKO	80	mt.	4,039
001 014 930010 20 00	30X10 MM KABLO KANALI-EKO (BÖLMELİ)	140	mt.	1,547
001 014 030015 20 00	30X15 MM KABLO KANALI-EKO	140	mt.	1,663
001 014 930016 20 00	30X16 MM KABLO KANALI-EKO (BÖLMELİ)	140	mt.	1,790
001 014 030016 20 00	30X16 MM KABLO KANALI-EKO	140	mt.	1,704
001 014 030025 20 00	30X25 MM KABLO KANALI-EKO	80	mt.	2,123
001 114 030030 20 00	30X30 MM KABLO KANALI-EKO	80	mt.	2,365
001 014 940016 20 00	40X16 MM KABLO KANALI-EKO (BÖLMELİ)	100	mt.	2,304
001 014 040016 20 00	40X16 MM KABLO KANALI-EKO	100	mt.	1,903
001 014 040025 20 00	40X25 MM KABLO KANALI-EKO	80	mt.	2,457
001 014 040040 20 00	40X40 MM KABLO KANALI-EKO	50	mt.	2,992
001 014 040060 20 00	40X60 MM KABLO KANALI-EKO	40	mt.	5,931
001 014 960025 20 00	60X25 MM KABLO KANALI-EKO (BÖLMELİ)	40	mt.	4,072
001 014 060040 20 00	60X40 MM KABLO KANALI-EKO	40	mt.	4,532
001 014 050050 20 00	50X50 MM KABLO KANALI-EKO	30	mt.	5,151
001 014 060060 20 00	60X60 MM KABLO KANALI-EKO	32	mt.	5,720
001 014 075075 20 00	75X75 MM KABLO KANALI-EKO	18	mt.	8,465
001 014 080040 20 00	80X40 MM KABLO KANALI-EKO	30	mt.	6,465
001 014 080060 20 00	80X60 MM KABLO KANALI-EKO	24	mt.	6,765
001 014 100040 20 00	100X40 MM KABLO KANALI-EKO (PRİZ SETİ TAKILABİLİR)	24	mt.	8,565
001 014 100037 20 00	100x37 İÇTEN KAPAKLI KANAL-EKO (PRİZ SETİ TAKILABİLİR)	30	mt.	8,465
001 014 100050 20 00	100X50 İÇTEN KAPAKLI KANAL-EKO (PRİZ SETİ TAKILABİLİR) FOLYOLU	20	mt.	8,492
001 014 100060 20 00	100X60 MM KABLO KANALI-EKO (PRİZ SETİ TAKILABİLİR)	20	mt.	8,808
001 014 120060 20 00	120X60 MM KABLO KANALI-EKO	16	mt.	12,980
001 014 100100 20 00	100X100 MM KABLO KANALI-EKO	20	mt.	17,464
<b>YAPIŞKAN BANTLI KAPALI TİP KABLO KANALLARI (EKO SERİSİ)</b>				
001 004 009005 20 00	9X5 MM KEN.KAPAKLI KANAL-YPŞK.BANTLI	500	mt.	0,774
001 004 010007 20 44	9,5X7 MM ŞEFFAF MİNİ KANAL-YPŞK.BANTLI	500	mt.	0,985
001 004 012007 20 00	12X7,5 MM KEN.KAPAKLI KANAL-YPŞK.BANTLI	350	mt.	0,829
001 004 013012 20 00	13X12,5 MM KEN.KAPAKLI KANAL-YPŞK.BANTLI	300	mt.	1,337
001 004 010008 20 00	10X8 MM KABLO KANALI-YPŞK.BANTLI	330	mt.	0,679
001 004 012012 20 00	12X12 MM KABLO KANALI-YPŞK.BANTLI	250	mt.	0,805
001 004 015010 20 00	15X10 MM KABLO KANALI-YPŞK.BANTLI	230	mt.	0,927
001 004 016016 20 00	16X16 MM KABLO KANALI-YPŞK.BANTLI	230	mt.	1,179
001 004 020010 20 00	20X10 MM KABLO KANALI-YPŞK.BANTLI	180	mt.	1,092
001 004 025016 20 00	25X16 MM KABLO KANALI-YPŞK.BANTLI	150	mt.	1,723
001 004 025025 20 00	25X25 MM KABLO KANALI-YPŞK.BANTLI	100	mt.	2,013
001 004 025040 20 00	25X40 MM KABLO KANALI-YPŞK.BANTLI	80	mt.	3,447
001 004 930010 20 00	30X10 MM KABLO KANALI-YPŞK.BANTLI-BÖLM.	140	mt.	1,699
001 004 030016 20 00	30X16 MM KABLO KANALI-YPŞK.BANTLI	140	mt.	1,880
001 004 030025 20 00	30X25 MM KABLO KANALI-YPŞK.BANTLI	80	mt.	2,362
001 004 040016 20 00	40X16 MM KABLO KANALI-YPŞK.BANTLI	100	mt.	2,676
001 004 040025 20 00	40X25 MM KABLO KANALI-YPŞK.BANTLI	80	mt.	3,304
001 004 040040 20 00	40X40 MM KABLO KANALI-YPŞK.BANTLI	50	mt.	3,835
001 004 060040 20 00	60X40 MM KABLO KANALI-YPŞK.BANTLI	40	mt.	5,720
001 004 060015 20 17	60X15 MM BALIK SIRTİ -YPŞK.BANTLI	80	mt.	4,785
001 004 075018 20 17	75X18 MM BALIK SIRTİ -YPŞK BANTLI	60	mt.	7,150
001 004 090020 20 17	90X20 MM BALIK SIRTİ -YPŞK BANTLI	40	mt.	9,012

Ürün Kodu	Açıklama / Stok Cinsi	Ambalaj (Kutulu)	Ambalaj Birimi	TL
<b>KANAL İÇİN UPS VE ENERJİ PRİZLERİ (45X45) TSE'Lİ</b>				
001 052 300001 00 00	45X45 TOP.PRİZ ÇEKİRDEĞİ (ÇCK.KOR.) (45° AÇILI)	TSE	50 ad.	4,125
001 052 300002 00 00	45X45 UPS TOP.PRİZ ÇEKİRDEĞİ (ÇCK.KOR.) (45° AÇILI)	TSE	50 ad.	4,400
001 052 500001 00 00	45X45 TOP.PRİZ ÇEKİRDEĞİ (ÇCK.KOR.)		30 ad.	6,050
001 052 500002 00 00	45X45 UPS TOP.PRİZ ÇEKİRDEĞİ (ÇCK.KOR.)		30 ad.	6,468
001 052 200005 00 00	45X45 PRİZ BİRLEŞTİRME APARATI		50 ad.	2,167
888 049 050008	DATA KONNEKTÖRÜ CAT 5e (RJ65 8 Kontak Tolles)		1 ad.	1,375 USD.
888 049 050032	DATA KONNEKTÖRÜ CAT 6e (RJ65 8 Kontak Tolles)		1 ad.	1,980 USD.
888 049 050009	TELEFON KONNEKTÖRÜ (RJ 11/12 6 Kontak)		1 ad.	1,210 USD.
888 049 050013	45X45 DATA PRİZ KAPAĞI		1 ad.	0,748 USD.
888 049 050012	45X22,5 DATA PRİZ KAPAĞI		1 ad.	0,616 USD.
888 049 051012	45X22,5 DATA PRİZ KAPAĞI YANMAZ		1 ad.	1,320 USD.

<b>DÖŞEME ALTI PRİZ SİSTEMLERİ</b>				
075 171 222508	8 MODÜL DÖŞEME ALTI PRİZ SİSTEMİ(BOŞ) 221X255		1 ad.	43,125
075 171 333308	8 MODÜL DÖŞEME ALTI PRİZ SİSTEMİ BUATI 330X330		1 ad.	46,000
075 171 272712	12 MODÜL DÖŞEME ALTI PRİZ SİSTEMİ(BOŞ) 270X270		1 ad.	66,125
075 171 424212	12 MODÜL DÖŞEME ALTI PRİZ SİSTEMİ BUATI 420X420		1 ad.	69,000
075 171 000040	S/Ü 3 MODÜL PRİZ UYGULAMA KASASI		1 ad.	35,000

<b>MEKS SERİSİ TSE'Lİ KAPALI TİP KABLO KANALLARI</b>				
001 002 010010 20 00	10X10 MM KABLO KANALI-MEKS	TSE	330 mt.	0,960
001 002 015015 20 00	15X15 MM KABLO KANALI-MEKS		250 mt.	1,092
001 002 016016 20 00	16X16 MM KABLO KANALI-MEKS		250 mt.	1,128
001 002 025016 20 00	25X16 MM KABLO KANALI-MEKS		150 mt.	1,512
001 002 025025 20 00	25X25 MM KABLO KANALI-MEKS		100 mt.	1,992
001 002 030015 20 00	30X15 MM KABLO KANALI-MEKS		140 mt.	2,148
001 002 030030 20 00	30X30 MM KABLO KANALI-MEKS		80 mt.	3,012
001 002 040017 20 00	40X17 MM KABLO KANALI-TAM KAPAKLI-MEKS		100 mt.	2,808
001 002 040025 20 00	40X25 MM KABLO KANALI-MEKS		80 mt.	2,784
001 002 040040 20 00	40X40 MM KABLO KANALI-MEKS		50 mt.	3,585
001 002 960025 20 00	60X25 MM KABLO KANALI-MEKS (BÖLMELİ)		40 mt.	4,547
001 002 060040 20 00	60X40 MM KABLO KANALI-MEKS		40 mt.	5,207
001 002 975022 20 00	75X22 MM KABLO KANALI-MEKS (BÖLMELİ)		50 mt.	7,182
001 002 080060 20 00	80X60 MM KABLO KANALI-MEKS		24 mt.	8,367
001 002 100036 20 00	100X36 MM KABLO KANALI-MEKS		30 mt.	10,354
001 002 100040 20 00	100X40 MM KABLO KANALI-MEKS		24 mt.	10,825
001 002 100048 20 00	100X48 MM KABLO KANALI-MEKS		24 mt.	11,666
001 002 120070 20 00	120X70 MM KABLO KANALI (İÇTEN KAPAKLI) (AKSESUARSIZ)		16 mt.	17,091
001 002 170070 20 00	170X70 MM KABLO KANALI (İÇTEN KAPAKLI) (AKSESUARSIZ)		12 mt.	25,525
001 002 250070 20 00	250X70 MM KABLO KANALI (İÇTEN KAPAKLI) (AKSESUARSIZ)		8 mt.	35,625
001 002 100060 20 00	100X60 MM KABLO KANALI-MEKS		20 mt.	11,604
001 002 120060 20 00	120X60 MM KABLO KANALI-MEKS		16 mt.	15,120

<b>MEKS SERİSİ KAPALI TİP KABLO KANALLARI (İÇTEN KAPAKLI) IP40</b>				
001 002 100037 20 00	100X37 MM KABLO KANALI (İÇTEN KAPAKLI)-MEKS (FOLYOLU)		30 mt.	10,212
001 002 100041 20 00	100X41 MM KABLO KANALI (İÇTEN KAPAKLI)-MEKS (FOLYOLU)		24 mt.	10,369
001 002 100050 20 00	100X50 MM KABLO KANALI (İÇTEN KAPAKLI)-MEKS (FOLYOLU)		20 mt.	11,640

<b>MEKSPLUS SERİSİ KAPALI TİP KABLO KANALLARI</b>				
001 003 040025 20 00	40X25 MM KABLO KANALI (İÇTEN KAPAKLI)	TSE	80 mt.	3,617
001 003 100037 20 00	100X37 MM KABLO KANALI (İÇTEN KAPAKLI)		30 mt.	9,798
001 003 100041 20 00	100X41 MM KABLO KANALI (İÇTEN KAPAKLI)		24 mt.	10,096
001 003 100050 20 00	100X50 MM KABLO KANALI (İÇTEN KAPAKLI) (2MM EK KALIN)		20 mt.	12,705
001 003 120070 20 00	120X70 MM KABLO KANALI (İÇTEN KAPAKLI) (AKSESUARSIZ)		16 mt.	16,077
001 003 170050 20 00	170X50 MM KABLO KANALI (İÇTEN KAPAKLI) (AKSESUARSIZ)		8 mt.	26,427
001 003 250070 20 00	250X70 MM KABLO KANALI (İÇTEN KAPAKLI) (AKSESUARSIZ)		8 mt.	36,880
001 006 100050 20 00	100X50 MM KABLO KANALI (İÇTEN KAPAKLI) (KPMS SERİSİ)		20 mt.	15,094
001 888 100050 00 00	100X50 MM KPMS SERİSİ PRİZ MONTAJ APARATI		50 ad.	1,980

<b>H.FREE SERİSİ KAPALI TİP KABLO KANALI</b>				
001 060 025025 20 00	25X25 KABLO KANALI HALOJEN FREE	CE	100 mt.	8,610
001 060 040040 20 00	40X40 KABLO KANALI HALOJEN FREE		50 mt.	11,310

<b>H.FREE SERİSİ KAPALI TİP KABLO KANALI VE AKSESUARLARI (FLARET)</b>				
001 060 100050 20 00	100X50 MM. KABLO KANALI HALOJEN FREE (İÇTEN KAPAKLI)	CE	20 mt.	45,000
001 061 100050 20 00	100X50 MM. KABLO KANALI HALOJEN FREE ARA BÖLME		150 mt.	4,552
001 039 100050 11 00	100X50-100X37 İÇ KÖŞE (HAREKETLİ) (H.FREE)		12 ad.	6,198
001 040 100050 11 00	100X50 MM. DIŞ KÖŞE (HAREKETLİ) (H.FREE)		10 ad.	7,590
001 041 100050 11 00	100X50 MM. T PARÇASI (H.FREE)		8 ad.	6,751
001 042 100050 11 00	100X50 MM. 90 L KÖŞE (H.FREE)		8 ad.	6,514
001 043 100050 11 00	100X50 MM. EK PARÇA (ÜÇLÜ SET) (H.FREE)		100 ad.	1,327
001 044 100050 11 00	100X50 MM. UÇ TAPA (H.FREE)		40 ad.	2,832
001 047 100001 11 00	PMS(100X37/50)(45X45)(1Lİ) İÇTEN KLİPSLİ (H.FREE)		20 ad.	4,474
001 047 100002 11 00	PMS(100X37/50)(45X45)(2Lİ) İÇTEN KLİPSLİ (H.FREE)		14 ad.	5,881
001 047 100003 11 00	PMS(100X37/50)(45X45)(3LÜ) İÇTEN KLİPSLİ (H.FREE)		12 ad.	7,822



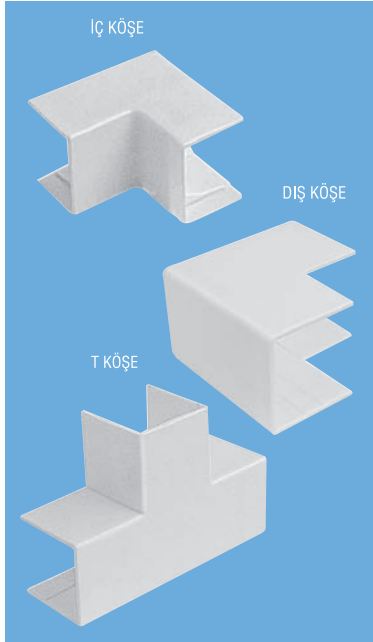
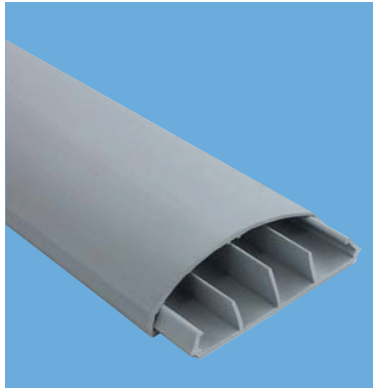

Ürün Kodu	Açıklama / Stok Cinsi	Ambalaj (Kutulu)	Ambalaj Birimi	TL
<b>MEKS SERİSİ KLİMA KANALI VE AKSESUARLARI</b>				
001 002 075060 20 00	75X60 MM KLİMA KANALI	30	mt.	7,000
001 050 030002 00 00	KLİMA KANALI KABLO TUTUCUSU	60	ad.	1,034
001 043 075060 00 00	KLİMA KANALI EK PARÇASI	40	ad.	1,063
001 039 075060 00 00	KLİMA KANALI İÇ KÖŞE	24	ad.	1,906
001 040 075060 00 00	KLİMA KANALI DIŞ KÖŞE	24	ad.	2,022
001 042 075060 00 00	KLİMA KANALI L KÖŞE	18	ad.	2,218
001 050 030001 00 00	KLİMA KANALI DUVAR GEÇİŞİ	60	ad.	1,184
001 044 075060 01 00	KLİMA KANALI İÇ SONLAMA	30	ad.	1,727
001 044 075060 02 00	KLİMA KANALI DIŞ SONLAMA	18	ad.	1,768
<b>TAVAN KÖŞE KANALI</b>				
001 002 023023 20 00	23X23 MM TAVAN KÖŞE KANALI	120	mt.	2,090
<b>FUGALI SÜPÜRGELİK</b>				
001 010 000200 20 00	50'LİK FUGALI SÜPÜRGELİK	60	mt.	1,925
<b>TEZGAH SÜPÜRGELİĞİ</b>				
001 011 000100 00 00	25'LİK TEZGAH SÜPÜRGELİĞİ 100CM	60	mt.	2,750
<b>BALIK SIRTI ZEMİN KANALLARI</b>				
001 002 060015 20 17	60X15 MM BALIK SIRTI KANAL (ZEMİN İÇİN)	80	mt.	3,638
001 042 060015 00 17	60X15 MM BALIK SIRTI KANAL L KÖŞE	24	ad.	1,045
001 043 060015 00 17	60X15 MM BALIK SIRTI KANAL EK PARÇASI	50	ad.	0,664
001 044 060015 00 17	60X15 MM BALIKSIRTI KANAL SONLAMA KAPAĞI	50	ad.	0,629
001 041 060015 00 17	60X15 MM BALIK SIRTI KANAL T KÖŞE	10	ad.	2,079
001 002 075018 20 17	75X18 MM BALIK SIRTI KANAL (ZEMİN İÇİN)	60	mt.	6,207
001 042 075018 00 17	75X18 MM BALIK SIRTI KANAL L KÖŞE	15	ad.	0,993
001 043 075018 00 17	75X18 MM BALIK SIRTI KANAL EK PARÇASI	50	ad.	0,496
001 044 075018 00 17	75X18 MM BALIKSIRTI KANAL SONLAMA KAPAĞI	50	ad.	0,526
001 041 075018 00 17	75X18 MM BALIK SIRTI KANAL T KÖŞE	8	ad.	1,881
001 002 090020 20 17	90X20 MM BALIK SIRTI KANAL (ZEMİN İÇİN)	40	mt.	8,157
001 042 090020 00 17	90X20 MM BALIK SIRTI KANAL L KÖŞE	20	ad.	1,231
001 043 090020 00 17	90X20 MM BALIK SIRTI KANAL EK PARÇASI	50	ad.	0,547
001 044 090020 00 17	90X20 MM BALIKSIRTI KANAL SONLAMA KAPAĞI	50	ad.	0,547
001 041 090020 00 17	90X20 MM BALIK SIRTI KANAL T KÖŞE	12	ad.	2,189
<b>12X12 KANAL AKSESUARLARI</b>				
001 039 012012 00 00	12X12 MM İÇ KÖŞE	60	ad.	0,613
001 040 012012 00 00	12X12 MM DIŞ KÖŞE	60	ad.	0,613
001 041 012012 00 00	12X12 MM T KÖŞE	60	ad.	0,613
001 042 012012 00 00	12X12 MM 90 L KÖŞE	60	ad.	0,613
001 044 012012 00 00	12X12 MM UÇ TAPA	100	ad.	0,613
001 043 012012 00 00	12X12 MM EK PARÇASI	100	ad.	0,613
<b>15X10 KANAL AKSESUARLARI</b>				
001 039 015010 00 00	15X10 MM İÇ KÖŞE	60	ad.	0,624
001 040 015010 00 00	15X10 MM DIŞ KÖŞE	60	ad.	0,624
001 041 015010 00 00	15X10 MM T KÖŞE	60	ad.	0,624
001 042 015010 00 00	15X10 MM 90 L KÖŞE	60	ad.	0,624
001 044 015010 00 00	15X10 MM UÇ TAPA	100	ad.	0,624
001 043 016016 00 00	15X10 MM EK PARÇASI	100	ad.	0,624
<b>20X10 KANAL AKSESUARLARI</b>				
001 039 020010 00 00	20X10 MM İÇ KÖŞE	60	ad.	0,659
001 040 020010 00 00	20X10 MM DIŞ KÖŞE	60	ad.	0,659
001 041 020010 00 00	20X10 MM T KÖŞE	30	ad.	0,659
001 042 020010 00 00	20X10 MM 90 L KÖŞE	50	ad.	0,659
001 044 020010 00 00	20X10 MM UÇ TAPA	100	ad.	0,659
001 043 020010 00 00	20X10 MM EK PARÇASI	100	ad.	0,659

Ürün Kodu	Açıklama / Stok Cinsi	Ambalaj (Kutulu)	CE	Ambalaj Birimi	TL
<b>16X16 KANAL AKSESUARLARI</b>					
001 039 016016 00 00	16X16 MM İÇ KÖŞE	60		ad.	0,636
001 040 016016 00 00	16X16 MM DIŞ KÖŞE	60		ad.	0,636
001 041 016016 00 00	16X16 MM T KÖŞE	60		ad.	0,936
001 042 016016 00 00	16X16 MM 90 L KÖŞE	60		ad.	0,636
001 044 016016 00 00	16X16 MM UÇ TAPA	100		ad.	0,636
001 043 016016 00 00	16X16 MM EK PARÇASI	100		ad.	0,659
<b>25X16 KANAL AKSESUARLARI</b>					
001 039 025016 00 00	25X16 MM İÇ KÖŞE	40		ad.	0,693
001 040 025016 00 00	25X16 MM DIŞ KÖŞE	40		ad.	0,710
001 041 025016 00 00	25X16 MM T KÖŞE	30		ad.	1,029
001 042 025016 00 00	25X16 MM 90 L KÖŞE	50		ad.	0,770
001 044 025016 00 00	25X16 MM UÇ TAPA	100		ad.	0,693
001 043 025016 00 00	25X16 MM EK PARÇA	100		ad.	0,693
001 047 01742100 00	25X16 MM PRİZ MONTAJ KASASI (45x45)	6		ad.	8,143
<b>25X25 KANAL AKSESUARLARI</b>					
001 039 025025 00 00	25X25 MM İÇ KÖŞE	40		ad.	0,728
001 040 025025 00 00	25X25 MM DIŞ KÖŞE	40		ad.	0,728
001 041 025025 00 00	25X25 MM T PARÇASI	24		ad.	1,098
001 042 025025 00 00	25X25 MM 90 L KÖŞE	40		ad.	0,728
001 044 025025 00 00	25X25 MM UÇ TAPA	100		ad.	0,728
001 043 025025 00 00	25X25 MM EK PARÇA	50		ad.	0,728
001 047 01742100 00	25X25 MM PRİZ MONTAJ KASASI (45x45)	6		ad.	8,143
<b>30X10 KANAL AKSESUARLARI</b>					
001 039 030010 00 00	30X10 MM İÇ KÖŞE	50		ad.	1,299
001 040 030010 00 00	30X10 MM DIŞ KÖŞE	50		ad.	1,299
001 041 030010 00 00	30X10 MM T PARÇASI	50		ad.	0,999
001 042 030010 00 00	30X10 MM 90 L KÖŞE	50		ad.	1,091
001 044 030025 00 00	30X10-16-25 MM UÇ TAPA	100		ad.	0,982
001 043 030025 00 00	30X10-16-25 MM EK PARÇA	100		ad.	0,924
<b>30X16 KANAL AKSESUARLARI</b>					
001 039 030016 00 00	30X16 MM İÇ KÖŞE	35		ad.	1,352
001 040 030016 00 00	30X16 MM DIŞ KÖŞE	48		ad.	1,352
001 041 030016 00 00	30X16 MM T PARÇASI	40		ad.	1,040
001 042 030016 00 00	30X16 MM 90 L KÖŞE	50		ad.	1,091
001 044 030025 00 00	30X10-16-25 MM UÇ TAPA	100		ad.	0,982
001 043 030025 00 00	30X10-16-25 MM EK PARÇA	100		ad.	0,924
<b>30X25 KANAL AKSESUARLARI</b>					
001 039 030025 00 00	30X25 MM İÇ KÖŞE	32		ad.	1,478
001 040 030025 00 00	30X25 MM DIŞ KÖŞE	30		ad.	1,478
001 041 030025 00 00	30X25 MM T PARÇASI	24		ad.	1,121
001 042 030025 00 00	30X25 MM 90 L KÖŞE	30		ad.	1,150
001 044 030025 00 00	30X10-16-25 MM UÇ TAPA	100		ad.	0,982
001 043 030025 00 00	30X10-16-25 MM EK PARÇA	100		ad.	0,924
<b>40X16 KANAL AKSESUARLARI</b>					
001 039 040016 00 00	40X16 MM İÇ KÖŞE	32		ad.	1,340
001 040 040016 00 00	40X16 MM DIŞ KÖŞE	30		ad.	1,340
001 041 040016 00 00	40X16 MM T KÖŞE	24		ad.	1,098
001 042 040016 00 00	40X16 MM 90 L KÖŞE	34		ad.	1,098
001 044 040040 00 00	40X16-25-40 MM UÇ TAPA	25		ad.	1,213
001 043 040040 00 00	40X16-25-40 MM EK PARÇA	100		ad.	1,098
001 047 01742100 00	40X16 MM PRİZ MONTAJ KASASI (45x45)	6		ad.	8,143

EK PARÇA

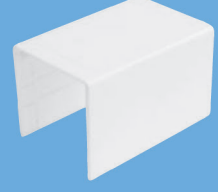

UÇ TAPA

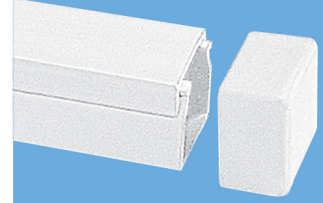

İÇ KÖŞE

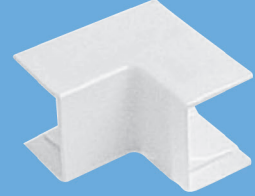

DIŞ KÖŞE

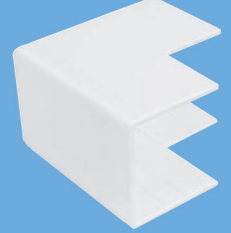

L KÖŞE

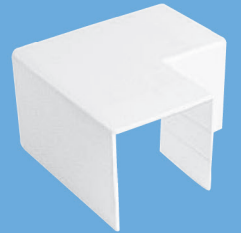

İÇ KÖŞE

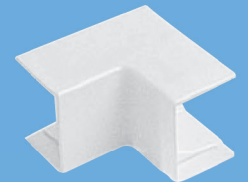

DIŞ KÖŞE

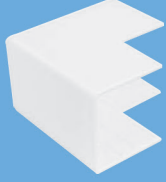

PRİZ MONTAJ KASASI

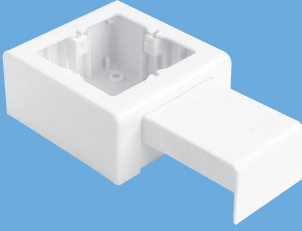

L KÖŞE

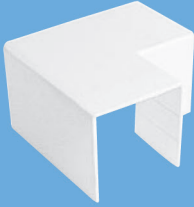

SONLAMA

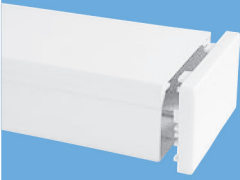

EK PARÇA



T KÖŞE

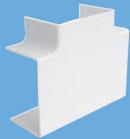

İÇ KÖŞE



DIŞ KÖŞE



Ürün Kodu	Açıklama / Stok Cinsi	Ambalaj (Kutulu)	CE	Ambalaj Birimi	TL
<b>40X25 KANAL AKSESUARLARI</b>					
001 039 040025 00 00	40X25 MM İÇ KÖŞE	24		ad.	1,444
001 040 040025 00 00	40X25 MM DIŞ KÖŞE	30		ad.	1,444
001 041 040025 00 00	40X25 MM T KÖŞE	18		ad.	1,155
001 042 040025 00 00	40X25 MM 90 L KÖŞE	24		ad.	1,155
001 044 040040 00 00	40X16-25-40 MM UÇ TAPA	25		ad.	1,213
001 043 040040 00 00	40X16-25-40 MM EK PARÇA	70		ad.	1,098
001 047 017421 00 00	40X25 MM PRİZ MONTAJ KASASI (45x45)	6		ad.	8,143
<b>40X40 KANAL AKSESUARLARI</b>					
001 039 040040 00 00	40X40 MM İÇ KÖŞE	18		ad.	1,213
001 040 040040 00 00	40X40 MM DIŞ KÖŞE	10		ad.	1,686
001 041 040040 00 00	40X40 MM T PARÇASI	48		ad.	1,363
001 042 040040 00 00	40X40 MM 90 L KÖŞE	60		ad.	1,213
001 044 040040 00 00	40X16-25-40 MM UÇ TAPA	25		ad.	1,213
001 043 040040 00 00	40X16-25-40 MM EK PARÇA	100		ad.	1,098
001 047 017421 00 00	40X40 MM PRİZ MONTAJ KASASI (45x45)	6		ad.	8,143
<b>75X22 KANAL AKSESUARLARI</b>					
001 039 075022 00 00	75X22 MM İÇ KÖŞE	20		ad.	1,427
001 040 075022 00 00	75X22 MM DIŞ KÖŞE	20		ad.	1,427
001 044 075022 01 00	75X22 MM SAĞ SONLAMA	30		ad.	1,427
001 044 075022 02 00	75X22 MM SOL SONLAMA	20		ad.	1,427
001 043 075022 00 00	75X22 MM EK PARÇASI	100		ad.	1,427
<b>60X25 KANAL AKSESUARLARI</b>					
001 039 060025 00 00	60X25 MM İÇ KÖŞE	48		ad.	2,873
001 040 060025 00 00	60X25 MM DIŞ KÖŞE	72		ad.	2,873
001 041 060025 00 00	60X25 MM T PARÇASI	40		ad.	2,873
001 042 060025 00 00	60X25 MM 90 L KÖŞE	60		ad.	2,873
001 044 060025 00 00	60X25 MM UÇ TAPA	50		ad.	1,283
001 043 060060 00 00	60X25-40-60 MM EK PARÇA	60		ad.	0,999
<b>60X40 KANAL AKSESUARLARI</b>					
001 039 060040 00 00	60X40 MM İÇ KÖŞE	26		ad.	2,873
001 040 060040 00 00	60X40 MM DIŞ KÖŞE	32		ad.	2,873
001 041 060040 00 00	60X40 MM T PARÇASI	32		ad.	2,873
001 042 060040 00 00	60X40 MM 90 L KÖŞE	40		ad.	2,873
001 044 060040 00 00	60X40 MM UÇ TAPA	50		ad.	1,224
001 043 060060 00 00	60X25-40-60 MM EK PARÇA	40		ad.	0,999
<b>60X60 KANAL AKSESUARLARI</b>					
001 039 060060 00 00	60X60 MM İÇ KÖŞE (HAREKETLİ)	16		ad.	2,888
001 040 060060 00 00	60X60 MM DIŞ KÖŞE (HAREKETLİ)	16		ad.	3,119
001 041 060060 00 00	60X60 MM T PARÇASI	20		ad.	2,888
001 042 060060 00 00	60X60 MM 90 L KÖŞE	24		ad.	2,888
001 044 060060 00 00	60X60 MM UÇ TAPA	30		ad.	1,163
001 043 060060 00 00	60X25-40-60 MM EK PARÇA	25		ad.	0,999
<b>80X40 KANAL AKSESUARLARI</b>					
001 039 080040 00 00	80X40 MM İÇ KÖŞE	18		ad.	3,119
001 040 080040 00 00	80X40 MM DIŞ KÖŞE	8		ad.	3,119
001 041 080040 00 00	80X40 MM T PARÇASI	12		ad.	3,119
001 042 080040 00 00	80X40 MM 90 L KÖŞE	16		ad.	3,234
001 044 080040 00 00	80X40 MM UÇ TAPA	60		ad.	1,213
001 043 080040 00 00	80X40 MM EK PARÇA	100		ad.	1,155
<b>80X60 KANAL AKSESUARLARI</b>					
001 039 080060 00 00	80X60 MM İÇ KÖŞE	12		ad.	3,215
001 040 080060 00 00	80X60 MM DIŞ KÖŞE	8		ad.	3,215
001 041 080060 00 00	80X60 MM T PARÇASI	10		ad.	3,523
001 042 080060 00 00	80X60 MM 90 L KÖŞE	12		ad.	3,215
001 044 080060 00 00	80X60 MM UÇ TAPA	48		ad.	1,329
001 043 080060 00 00	80X60 MM EK PARÇA	80		ad.	1,455

Ürün Kodu	Açıklama / Stok Cinsi	Ambalaj (Kutulu)	Ambalaj Birimi	TL
<b>100X36 KANAL AKSESUARLARI</b>				
001 039 100036 00 00	100X36 MM İÇ KÖŞE (SABİT)	8	ad.	3,523
001 040 100036 00 00	100X36 MM DIŞ KÖŞE (SABİT)	8	ad.	3,523
001 039 100040 01 00	100X36 MM İÇ KÖŞE (HAREKETLİ)	8	ad.	3,523
001 040 100040 01 00	100X36 MM DIŞ KÖŞE (HAREKETLİ)	10	ad.	3,523
001 041 100036 00 00	100X36 MM T PARÇASI	12	ad.	3,523
001 042 100036 00 00	100X36 MM 90 L KÖŞE	12	ad.	3,523
001 044 100060 00 00	100X36-40-48-60 MM UÇ TAPA	20	ad.	1,665
001 043 100060 00 00	100X36-40-48-60 MM EK PARÇA	100	ad.	1,100
001 050 030004 00 00	100X36 MM KANAL KİLİTLEME APARATI	100	ad.	0,410
001 013 100036 20 00	100X36 MM ARA BÖLME	200	mt.	1,802
<b>100X37 KANAL AKSESUARLARI</b>				
001 039 100037 00 00	100X37 MM İÇ KÖŞE (SABİT)	12	ad.	3,408
001 040 100037 00 00	100X37 MM DIŞ KÖŞE (SABİT)	8	ad.	3,408
001 039 100050 01 00	100X37 MM İÇ KÖŞE (HAREKETLİ)	12	ad.	3,408
001 040 100050 01 00	100X37 MM DIŞ KÖŞE (HAREKETLİ)	10	ad.	4,181
001 041 100037 00 00	100X37 MM T PARÇASI	12	ad.	3,408
001 042 100037 00 00	100X37 MM 90 L KÖŞE	12	ad.	3,408
001 044 100037 00 00	100X37 MM UÇ TAPA	50	ad.	1,665
001 043 100050 00 00	100X37-50 MM EK PARÇA	100	ad.	1,155
<b>100X40 KANAL AKSESUARLARI</b>				
001 039 100040 00 00	100X40 MM İÇ KÖŞE (SABİT)	8	ad.	3,523
001 040 100040 00 00	100X40 MM DIŞ KÖŞE (SABİT)	8	ad.	3,777
001 039 100040 01 00	100X40 MM İÇ KÖŞE (HAREKETLİ)	8	ad.	3,523
001 040 100040 01 00	100X40 MM DIŞ KÖŞE (HAREKETLİ)	10	ad.	3,523
001 041 100040 00 00	100X40 MM T PARÇASI	12	ad.	3,523
001 042 100040 00 00	100X40 MM 90 L KÖŞE	12	ad.	3,523
001 044 100060 00 00	100X36-40-48-60 MM UÇ TAPA	20	ad.	1,665
001 043 100060 00 00	100X36-40-48-60 MM EK PARÇA	100	ad.	1,100
001 050 030004 00 00	100X40 MM KANAL KİLİTLEME APARATI	100	ad.	0,410
001 013 100040 20 00	100X40 MM ARA BÖLME	200	mt.	1,860
<b>100X48 KANAL AKSESUARLARI</b>				
001 039 100048 00 00	100X48 MM İÇ KÖŞE (SABİT)	8	ad.	3,916
001 040 100048 00 00	100X48 MM DIŞ KÖŞE (SABİT)	8	ad.	3,916
001 039 100060 01 00	100X48 MM İÇ KÖŞE (HAREKETLİ)	8	ad.	3,904
001 040 100060 01 00	100X48 MM DIŞ KÖŞE (HAREKETLİ)	10	ad.	3,904
001 041 100048 00 00	100X48 MM T PARÇASI	8	ad.	3,904
001 042 100048 00 00	100X48 MM 90 L KÖŞE	8	ad.	3,904
001 044 100060 00 00	100X36-40-48-60 MM UÇ TAPA	20	ad.	1,665
001 043 100060 00 00	100X36-40-48-60 MM EK PARÇA	100	ad.	1,100
001 050 030004 00 00	100X48 MM KANAL KİLİTLEME APARATI	100	ad.	0,410
001 013 100048 20 00	100X48 MM ARA BÖLME	150	mt.	1,779
<b>MEKSPUS SERİSİ 100X37/50 İÇİN PRİZ SETLERİ (45x45)</b>				
001 047 070001 00 00	100X37/50 İÇİN 45X45 P.M.SETİ (TEK Lİ) YENİ	20	ad.	3,147
001 047 070002 00 00	100X37/50 İÇİN 45X45 P.M.SETİ (İKİLİ) YENİ	14	ad.	3,985
001 047 070003 00 00	100X37/50 İÇİN 45X45 P.M.SETİ (ÜÇ LÜ) YENİ	12	ad.	4,158
001 047 070004 00 00	100X37/50 İÇİN 45X45 P.M.SETİ (DÖRTLÜ) YENİ	10	ad.	4,816
<b>MEKSPUS SERİSİ 100X37/50 İÇİN PRİZ SETLERİ (55X55)</b>				
001 047 080001 00 00	100X37/50 İÇİN P.M.SETİ (TEK Lİ) YENİ	20	ad.	3,147
001 047 080002 00 00	100X37/50 İÇİN P.M.SETİ (İKİLİ) YENİ	14	ad.	3,420
001 047 080003 00 00	100X37/50 İÇİN P.M.SETİ (ÜÇ LÜ) YENİ	12	ad.	4,620
<b>100X50 - 100X41 KANAL AKSESUARLARI</b>				
001 039 100050 00 00	100X50-41 MM İÇ KÖŞE (SABİT)	8	ad.	3,465
001 040 100050 00 00	100X50-41 MM DIŞ KÖŞE (SABİT)	8	ad.	3,465
001 039 100050 01 00	100X50-41-37 MM İÇ KÖŞE (HAREKETLİ)	12	ad.	3,408
001 040 100050 01 00	100X50-41-37 MM DIŞ KÖŞE (HAREKETLİ)	10	ad.	4,181
001 041 100050 00 00	100X50-41 MM T KÖŞE	8	ad.	3,870
001 042 100050 00 00	100X50-41 MM 90 L KÖŞE	8	ad.	3,500
001 044 100050 00 00	100X50-41 MM UÇ TAPA	40	ad.	1,964
001 043 100050 00 00	100X50-37 MM EK PARÇA	100	ad.	1,386
001 043 100050 01 00	100X50 MM EK PARÇA (3LÜ SET)	100	ad.	1,386
001 046 195100 00 00	100X50 MM KANAL İÇİ KÜP BUAT	25	ad.	1,650
<b>100X50 KAİDESİZ KANAL AKSESUARLAR</b>				
001 039 100051 00 00	100X50 MM KAİDESİZ İÇ KÖŞE	8	ad.	3,983
001 040 100051 00 00	100X50 MM KAİDESİZ DIŞ KÖŞE	8	ad.	3,985
001 041 100051 00 00	100X50 MM KAİDESİZ T KÖŞE	8	ad.	4,450
001 042 100051 00 00	100X50 MM KAİDESİZ 90 L KÖŞE	8	ad.	4,025
001043 100051 00 00	100X50 MM KAİDESİZ EK PARÇA	100	ad.	1,260
001 044 100051 00 00	100X50 MM KAİDESİZ UÇ TAPA	40	ad.	1,600

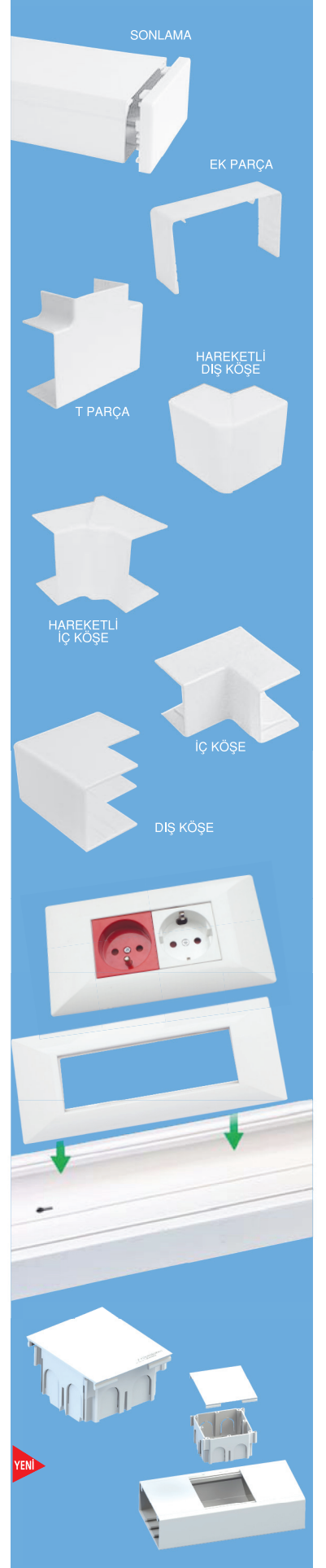

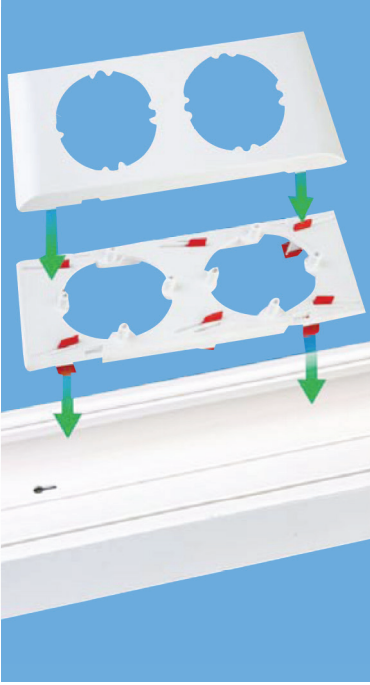

Ürün Kodu	Açıklama / Stok Cinsi	Ambalaj (Kutulu)	Ambalaj Birimi	TL
<b>100X60 KANAL AKSESUARLARI</b>				
001 039 100060 00 00	100X60 MM İÇ KÖŞE (SABİT)	8	ad.	3,465
001 040 100060 00 00	100X60 MM DIŞ KÖŞE (SABİT)	8	ad.	4,043
001 039 100060 01 00	100X60 MM İÇ KÖŞE (HAREKETLİ)	8	ad.	3,904
001 040 100060 01 00	100X60 MM DIŞ KÖŞE (HAREKETLİ)	10	ad.	3,904
001 041 100060 00 00	100X60 MM T PARÇASI	8	ad.	3,604
001 042 100060 00 00	100X60 MM 90 L KÖŞE	8	ad.	3,696
001 044 100060 00 00	100X36-40-48-60 MM UÇ TAPA	20	ad.	1,665
001 043 100060 00 00	100X36-40-48-60 MM EK PARÇA	100	ad.	1,100
001 050 030004 00 00	100X60 MM KANAL KİLİTLEME APARATI	100	ad.	0,410
001 013 100060 20 00	100X60 MM ARA BÖLME	130	mt.	2,230
<b>MEKS SERİSİ 100'LÜK KANAL. İÇİN PRİZ MONTAJ SET. (55X55)</b>				
001 047 020001 00 00	100'LÜK KANAL İÇİN P.M.SETİ TEKLİ	20	ad.	3,147
001 047 020002 00 00	100'LÜK KANAL İÇİN P.M.SETİ İKİLİ	14	ad.	3,950
001 047 020003 00 00	100'LÜK KANAL İÇİN P.M.SETİ ÜÇLÜ	12	ad.	5,082
<b>MEKS SERİSİ 100'LÜK KANAL. İÇİN PRİZ MONTAJ SET. (45X45)</b>				
001 047 040001 00 00	100'LÜK KANAL İÇİN 45X45 P.M.SETİ TEKLİ	20	ad.	3,147
001 047 040002 00 00	100'LÜK KANAL İÇİN 45X45 P.M.SETİ İKİLİ	14	ad.	3,540
001 047 040003 00 00	100'LÜK KANAL İÇİN 45X45 P.M.SETİ ÜÇLÜ	12	ad.	4,043
001 047 040004 00 00	100'LÜK KANAL İÇİN 45X45 P.M.SETİ DÖRTLÜ	10	ad.	4,563
<b>120X60 KANAL AKSESUARLARI</b>				
001 039 120060 00 00	120X60 MM İÇ KÖŞE	8	ad.	4,274
001 040 120060 00 00	120X60 MM DIŞ KÖŞE	8	ad.	4,274
001 041 120060 00 00	120X60 MM T PARÇA	8	ad.	4,274
001 042 120060 00 00	120X60 MM 90 L KÖŞE	8	ad.	4,274
001 047 060001 00 00	120X60 MM PRİZ MONTAJ ÇERV.TEKLİ	20	ad.	3,673
001 047 060002 00 00	120X60 MM PRİZ MONTAJ ÇERV.İKİLİ	20	ad.	4,158
001 047 060003 00 00	120X60 MM PRİZ MONTAJ ÇERV.ÜÇLÜ	20	ad.	4,794
001 044 120060 00 00	120X60 MM UÇ TAPA	20	ad.	1,665
001 043 120060 00 00	120X60 MM EK PARÇA	50	ad.	1,231
<b>SİDEM SERİSİ RENKLİ KABLO KANALLARI</b>				
001 007 010008 20 0X	10X8 MM KABLO KANALI (SİDEM)	330	mt.	2,715
001 007 012012 20 0X	12X12 MM KABLO KANALI (SİDEM)	250	mt.	2,830
001 007 015010 20 0X	15X10 MM KABLO KANALI (SİDEM)	250	mt.	3,003
001 007 016016 20 0X	16X16 MM KABLO KANALI (SİDEM)	250	mt.	3,234
001 007 020010 20 0X	20X10 MM KABLO KANALI (SİDEM)	200	mt.	3,061
001 007 025016 20 0X	25X16 MM KABLO KANALI (SİDEM)	150	mt.	3,927
001 007 025025 20 0X	25X25 MM KABLO KANALI (SİDEM)	100	mt.	5,140
001 007 930010 20 0X	30X10 MM KABLO KANALI (SİDEM) (BÖLMELİ)	140	mt.	3,927
001 007 930016 20 0X	30X16 MM KABLO KANALI (SİDEM) (BÖLMELİ)	140	mt.	5,025
001 007 030025 20 0X	30X25 MM KABLO KANALI (SİDEM)	80	mt.	5,452
001 007 040016 20 0X	40X16 MM KABLO KANALI (SİDEM)	100	mt.	5,336
001 007 940016 20 0X	40X16 MM KABLO KANALI (SİDEM) (BÖLMELİ)	100	mt.	5,602
001 007 040025 20 0X	40X25 MM KABLO KANALI (SİDEM)	80	mt.	6,642
001 007 040040 20 0X	40X40 MM KABLO KANALI (SİDEM)	50	mt.	8,547
001 007 960025 20 0X	60X25 MM KABLO KANALI (SİDEM) (BÖLMELİ)	40	mt.	9,876
001 007 060040 20 0X	60X40 MM KABLO KANALI (SİDEM)	40	mt.	10,973
001 007 060060 20 0X	60X60 MM KABLO KANALI (SİDEM)	32	mt.	14,438
001 007 975022 20 0X	75X22 MM KABLO KANALI (SİDEM) (BÖLMELİ)	50	mt.	12,359
001 007 080040 20 0X	80X40 MM KABLO KANALI (SİDEM)	30	mt.	13,629
001 007 080060 20 0X	80X60 MM KABLO KANALI (SİDEM)	24	mt.	16,517
001 007 100036 20 0X	100X36 MM KABLO KANALI (SİDEM)	30	mt.	17,787
001 007 100040 20 0X	100X40 MM KABLO KANALI (SİDEM)	24	mt.	18,480
001 007 100048 20 0X	100X48 MM KABLO KANALI (SİDEM)	24	mt.	19,635
001 007 100060 20 0X	100X60 MM KABLO KANALI (SİDEM)	20	mt.	21,137
001 007 075060 20 0X	75X60 MM KLİMA KANALI (SİDEM)	30	mt.	16,055
001 007 100037 20 0X	100X37 MM KABLO KANALI(SİDEM)(I.KAPAKLI)	30	mt.	17,325
001 007 100050 20 0X	100X50 MM KABLO KANALI(SİDEM)(I.KAPAKLI)	20	mt.	19,982
001 007 120060 20 0X	120X60 MM KABLO KANALI(SİDEM)(I.KAPAKLI)	16	mt.	25,410
001 007 120070 20 0X	120X70 MM KABLO KANALI(SİDEM)	16	mt.	36,731
001 007 170070 20 0X	170X70 MM KABLO KANALI(SİDEM)	12	mt.	38,069

Ürün Kodu	Açıklama / Stok Cinsi	Ambalaj (Kutulu)	Ambalaj Birimi	TL
<b>SİDEM SERİSİ RENKLİ KABLO KANALLARI (YAPIŞKANLI)</b>				
001 155 010008 20 0X	10X8 MM KABLO KANALI (SİDEM) YAPIŞKANLI	330	mt.	2,888
001 155 012012 20 0X	12X12 MM KABLO KANALI (SİDEM) YAPIŞKANLI	250	mt.	3,003
001 155 015010 20 0X	15X10 MM KABLO KANALI (SİDEM) YAPIŞKANLI	250	mt.	3,205
001 155 016016 20 0X	16X16 MM KABLO KANALI (SİDEM) YAPIŞKANLI	250	mt.	3,431
001 155 020010 20 0X	20X10 MM KABLO KANALI (SİDEM) YAPIŞKANLI	180	mt.	3,326
001 155 025016 20 0X	25X16 MM KABLO KANALI (SİDEM) YAPIŞKANLI	150	mt.	4,297
001 155 025025 20 0X	25X25 MM KABLO KANALI (SİDEM) YAPIŞKANLI	100	mt.	5,267
001 155 930010 20 0X	30X10 MM KABLO KANALI (SİDEM) YAPIŞKANLI	140	mt.	3,639
001 155 930016 20 0X	30X16 MM KABLO KANALI (SİDEM) YAPIŞKANLI	140	mt.	5,198
001 155 030025 20 0X	30X25 MM KABLO KANALI (SİDEM) YAPIŞKANLI	80	mt.	5,602
001 155 040016 20 0X	40X16 MM KABLO KANALI (SİDEM) YAPIŞKANLI	100	mt.	6,122
001 155 040025 20 0X	40X25 MM KABLO KANALI (SİDEM) YAPIŞKANLI	80	mt.	7,392
001 155 040040 20 0X	40X40 MM KABLO KANALI (SİDEM) YAPIŞKANLI	50	mt.	9,263
001 155 960025 20 0X	60X25 MM KABLO KANALI (SİDEM) YAPIŞKANLI	40	mt.	11,146
001 155 060015 20 0X	60X15 MM KABLO KANALI (SİDEM) YAPIŞKANLI	50	mt.	8,778
001 155 075018 20 0X	75X18 MM KABLO KANALI (SİDEM) YAPIŞKANLI	50	mt.	13,179
001 155 060040 20 0X	60X40 MM KABLO KANALI (SİDEM) YAPIŞKANLI	40	mt.	12,243

<b>SİDEM SERİSİ SÜPÜRGELİKLER VE AKSESUARLARI</b>				
001 007 060015 20 0X	60X15 MM BALIK SIRTI KANAL (SİDEM)	80	mt.	7,508
001 031 060015 00 0X	60X15 MM BALIK SIRTI KANAL L KÖŞE(SİDEM)	1	ad.	3,077
001 032 060015 00 0X	60X15 MM BALIK SIRTI EK PARÇASI(SİDEM)	1	ad.	1,409
001 033 060015 00 0X	60X15 MM BALIKSIRTI SONLAMAKAPAĞI(SİDEM)	1	ad.	1,461
001 030 060015 00 0X	60X15 MM BALIKSIRTI T KÖŞE (SİDEM)	1	ad.	3,077
001 007 075018 20 0X	75X18 MM BALIK SIRTI KANAL (SİDEM)	60	mt.	11,955
001 007 090020 20 0X	90X20 MM BALIK SIRTI KANAL (SİDEM)	40	mt.	16,914

<b>12X12 KANAL AKSESUARLARI (SİDEM SERİSİ)</b>				
001 028 012012 00 0X	12X12 MM (SİDEM) İÇ KÖŞE	1	ad.	0,890
001 029 012012 00 0X	12X12 MM (SİDEM) DIŞ KÖŞE	1	ad.	0,890
001 030 012012 00 0X	12X12 MM (SİDEM) T KÖŞE	1	ad.	0,890
001 031 012012 00 0X	12X12 MM (SİDEM) 90 L KÖŞE	1	ad.	0,890
001 033 012012 00 0X	12X12 MM (SİDEM) UÇ TAPA	1	ad.	0,890
001 032 012012 00 0X	12X12 MM (SİDEM) EK PARÇASI	1	ad.	0,890

<b>15X10 KANAL AKSESUARLARI (SİDEM SERİSİ)</b>				
001 028 015010 00 0X	15X10 MM (SİDEM) İÇ KÖŞE	1	ad.	0,930
001 029 015010 00 0X	15X10 MM (SİDEM) DIŞ KÖŞE	1	ad.	0,930
001 030 015010 00 0X	15X10 MM (SİDEM) T KÖŞE	1	ad.	1,114
001 031 015010 00 0X	15X10 MM (SİDEM) 90 L KÖŞE	1	ad.	1,075
001 033 015010 00 0X	15X10 MM (SİDEM) UÇ TAPA	1	ad.	0,867
001 032 015010 00 0X	15X10 MM (SİDEM) EK PARÇASI	1	ad.	1,005

<b>16X16 KANAL AKSESUARLARI (SİDEM SERİSİ)</b>				
001 028 016016 00 0X	16X16 MM (SİDEM) İÇ KÖŞE	1	ad.	1,022
001 029 016016 00 0X	16X16 MM (SİDEM) DIŞ KÖŞE	1	ad.	0,906
001 030 016016 00 0X	16X16 MM (SİDEM) T KÖŞE	1	ad.	1,340
001 031 016016 00 0X	16X16 MM (SİDEM) 90 L KÖŞE	1	ad.	0,947
001 033 016016 00 0X	16X16 MM (SİDEM) UÇ TAPA	1	ad.	0,883
001 032 016016 00 0X	16X16 MM (SİDEM) EK PARÇASI	1	ad.	1,063

<b>20X10 KANAL AKSESUARLARI (SİDEM SERİSİ)</b>				
001 028 020010 00 0X	20X10 MM (SİDEM) İÇ KÖŞE	1	ad.	0,965
001 029 020010 00 0X	20X10 MM (SİDEM) DIŞ KÖŞE	1	ad.	0,965
001 030 020010 00 0X	20X10 MM (SİDEM) T KÖŞE	1	ad.	0,883
001 031 020010 00 0X	20X10 MM (SİDEM) 90 L KÖŞE	1	ad.	0,883
001 033 020010 00 0X	20X10 MM (SİDEM) UÇ TAPA	1	ad.	0,883
001 032 020010 00 0X	20X10 MM (SİDEM) EK PARÇASI	1	ad.	0,883

## RENK SEÇENEKLERİ



İÇ KÖŞE

DIŞ KÖŞE

L KÖŞE

T KÖŞE

EK PARÇA

İÇ KÖŞE



DIŞ KÖŞE

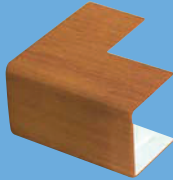

L KÖŞE



T KÖŞE

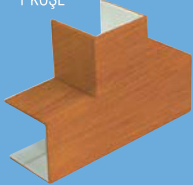

EK PARÇA



UÇ TAPA



Ürün Kodu	Açıklama / Stok Cinsi	Ambalaj (Kutulu)	Ambalaj Birimi	TL
<b>25X16 KANAL AKSESUARLARI (SİDEM SERİSİ)</b>				
001 028 025016 00 0 X	25X16 MM (SİDEM) İÇ KÖŞE	1	ad.	1,571
001 029 025016 00 0 X	25X16 MM (SİDEM) DIŞ KÖŞE	1	ad.	1,271
001 030 025016 00 0 X	25X16 MM (SİDEM) T KÖŞE	1	ad.	1,525
001 031 025016 00 0 X	25X16 MM (SİDEM) 90 L KÖŞE	1	ad.	1,271
001 033 025016 00 0 X	25X16 MM (SİDEM) UÇ TAPA	1	ad.	1,271
001 032 025016 00 0 X	25X16 MM (SİDEM) EK PARÇA	1	ad.	1,271
001 034 012516 00 0 X	25X16 MM (SİDEM) P.MONTAJ KASASI	1	ad.	9,309
<b>25X25 KANAL AKSESUARLARI (SİDEM SERİSİ)</b>				
001 028 025025 00 0 X	25X25 MM (SİDEM) İÇ KÖŞE	1	ad.	1,686
001 029 025025 00 0 X	25X25 MM (SİDEM) DIŞ KÖŞE	1	ad.	1,686
001 030 025025 00 0 X	25X25 MM (SİDEM) T PARÇASI	1	ad.	1,686
001 031 025025 00 0 X	25X25 MM (SİDEM) 90 L KÖŞE	1	ad.	1,340
001 033 025025 00 0 X	25X25 MM (SİDEM) UÇ TAPA	1	ad.	1,329
001 032 025025 00 0 X	25X25 MM (SİDEM) EK PARÇA	1	ad.	1,329
001 034 012525 00 0 X	25X25 MM (SİDEM) P.MONTAJ KASASI	1	ad.	9,309
<b>30X10 KANAL AKSESUARLARI (SİDEM SERİSİ)</b>				
001 028 030010 00 0 X	30X10 MM (SİDEM) İÇ KÖŞE	1	ad.	1,675
001 029 030010 00 0 X	30X10 MM (SİDEM) DIŞ KÖŞE	1	ad.	1,802
001 030 030010 00 0 X	30X10 MM (SİDEM) T PARÇASI	1	ad.	1,675
001 031 030010 00 0 X	30X10 MM (SİDEM) 90 L KÖŞE	1	ad.	1,675
001 033 030025 00 0 X	30X10-16-25 MM (SİDEM)UÇ TAPA	1	ad.	1,807
001 032 030025 00 0 X	30X10-16-25 MM (SİDEM)EK PARÇA	1	ad.	1,807
<b>30X16 KANAL AKSESUARLARI (SİDEM SERİSİ)</b>				
001 028 030016 00 0 X	30X16 MM (SİDEM) İÇ KÖŞE	1	ad.	1,825
001 029 030016 00 0 X	30X16 MM (SİDEM) DIŞ KÖŞE	1	ad.	1,883
001 030 030016 00 0 X	30X16 MM (SİDEM) T PARÇASI	1	ad.	1,791
001 031 030016 00 0 X	30X16 MM (SİDEM) 90 L KÖŞE	1	ad.	1,791
001 033 030025 00 0 X	30X10-16-25 MM (SİDEM)UÇ TAPA	1	ad.	1,807
001 032 030025 00 0 X	30X10-16-25 MM (SİDEM)EK PARÇA	1	ad.	1,807
<b>30X25 KANAL AKSESUARLARI (SİDEM SERİSİ)</b>				
001 028 030025 00 0 X	30X25 MM (SİDEM) İÇ KÖŞE	1	ad.	2,022
001 029 030025 00 0 X	30X25 MM (SİDEM) DIŞ KÖŞE	1	ad.	2,114
001 030 030025 00 0 X	30X25 MM (SİDEM) T PARÇASI	1	ad.	1,807
001 031 030025 00 0 X	30X25 MM (SİDEM) 90 L KÖŞE	1	ad.	1,807
001 033 030025 00 0 X	30X10-16-25 MM (SİDEM)UÇ TAPA	1	ad.	1,807
001 032 030025 00 0 X	30X10-16-25 MM (SİDEM)EK PARÇA	1	ad.	1,807
<b>40X16 KANAL AKSESUARLARI (SİDEM SERİSİ)</b>				
001 028 040016 00 0 X	40X16 MM (SİDEM) İÇ KÖŞE	1	ad.	2,276
001 029 040016 00 0 X	40X16 MM (SİDEM) DIŞ KÖŞE	1	ad.	1,964
001 030 040016 00 0 X	40X16 MM (SİDEM) T KÖŞE	1	ad.	1,906
001 031 040016 00 0 X	40X16 MM (SİDEM) 90 L KÖŞE	1	ad.	1,906
001 033 040040 00 0 X	40X16-25-40 MM (SİDEM) UÇ TAPA	1	ad.	2,137
001 032 040040 00 0 X	40X16-25-40 MM (SİDEM) EK PARÇA	1	ad.	2,137
001 034 014016 00 0 X	40X16 MM (SİDEM) P.MONTAJ KASASI	1	ad.	9,309
<b>40X25 KANAL AKSESUARLARI (SİDEM SERİSİ)</b>				
001 028 040025 00 0 X	40X25 MM (SİDEM) İÇ KÖŞE	1	ad.	2,022
001 029 040025 00 0 X	40X25 MM (SİDEM) DIŞ KÖŞE	1	ad.	2,195
001 030 040025 00 0 X	40X25 MM (SİDEM) T KÖŞE	1	ad.	2,022
001 031 040025 00 0 X	40X25 MM (SİDEM) 90 L KÖŞE	1	ad.	2,022
001 033 040040 00 0 X	40X16-25-40 MM (SİDEM) UÇ TAPA	1	ad.	2,137
001 032 040040 00 0 X	40X16-25-40 MM (SİDEM) EK PARÇA	1	ad.	2,137
001 034 014025 00 0 X	40X25 MM (SİDEM) P.MONTAJ KASASI	1	ad.	9,309
<b>40X40 KANAL AKSESUARLARI (SİDEM SERİSİ)</b>				
001 028 040040 00 0 X	40X40 MM (SİDEM) İÇ KÖŞE	1	ad.	2,461
001 029 040040 00 0 X	40X40 MM (SİDEM) DIŞ KÖŞE	1	ad.	2,518
001 030 040040 00 0 X	40X40 MM (SİDEM) T PARÇASI	1	ad.	2,148
001 031 040040 00 0 X	40X40 MM (SİDEM) 90 L KÖŞE	1	ad.	2,137
001 033 040040 00 0 X	40X16-25-40 MM (SİDEM) UÇ TAPA	1	ad.	2,137
001 032 040040 00 0 X	40X16-25-40 MM (SİDEM) EK PARÇA	1	ad.	2,137
001 034 014040 00 0 X	40X40 MM (SİDEM) P.MONTAJ KASASI	1	ad.	9,309

Ürün Kodu	Açıklama / Stok Cinsi	Ambalaj (Kutulu)	Ambalaj Birimi	TL
<b>75X22 KANAL AKSESUARLARI (SİDEM SERİSİ)</b>				
		TS	CE	
001 028 075022 00 0 X	75X22 MM (SİDEM) İÇ KÖŞE	1	ad.	2,657
001 029 075022 00 0 X	75X22 MM (SİDEM) DIŞ KÖŞE	1	ad.	2,657
001 033 075022 01 0 X	75X22 MM (SİDEM) SAĞ SONLAMA	1	ad.	2,657
001 033 075022 02 0 X	75X22 MM (SİDEM) SOL SONLAMA	1	ad.	2,657
001 032 075022 00 0 X	75X22 MM (SİDEM) EK PARÇASI	1	ad.	2,657
<b>60X25 KANAL AKSESUARLARI (SİDEM SERİSİ)</b>				
		TS	CE	
001 028 060025 00 0 X	60X25 MM (SİDEM) İÇ KÖŞE	1	ad.	4,514
001 029 060025 00 0 X	60X25 MM (SİDEM) DIŞ KÖŞE	1	ad.	4,514
001 030 060025 00 0 X	60X25 MM (SİDEM) T PARÇASI	1	ad.	4,514
001 031 060025 00 0 X	60X25 MM (SİDEM) 90 L KÖŞE	1	ad.	4,514
001 033 060025 00 0 X	60X25 MM (SİDEM) UÇ TAPA	1	ad.	2,022
001 032 060060 00 0 X	60X25-40-60 MM (SİDEM) EK PARÇA	1	ad.	1,999
<b>60X40 KANAL AKSESUARLARI (SİDEM SERİSİ)</b>				
		TS	CE	
001 028 060040 00 0 X	60X40 MM (SİDEM) İÇ KÖŞE	1	ad.	4,514
001 029 060040 00 0 X	60X40 MM (SİDEM) DIŞ KÖŞE	1	ad.	4,514
001 030 060040 00 0 X	60X40 MM (SİDEM) T PARÇASI	1	ad.	4,514
001 031 060040 00 0 X	60X40 MM (SİDEM) 90 L KÖŞE	1	ad.	4,514
001 033 060040 00 0 X	60X40 MM (SİDEM) UÇ TAPA	1	ad.	2,184
001 032 060060 00 0 X	60X25-40-60 MM (SİDEM) EK PARÇA	1	ad.	1,999
<b>60X60 KANAL AKSESUARLARI (SİDEM SERİSİ)</b>				
		TS	CE	
001 028 060060 00 0 X	60X60 MM (SİDEM) İÇ KÖŞE	1	ad.	4,514
001 029 060060 00 0 X	60X60 MM (SİDEM) DIŞ KÖŞE	1	ad.	4,514
001 030 060060 00 0 X	60X60 MM (SİDEM) T PARÇASI	1	ad.	4,514
001 031 060060 00 0 X	60X60 MM (SİDEM) 90 L KÖŞE	1	ad.	4,514
001 033 060060 00 0 X	60X60 MM (SİDEM) UÇ TAPA	1	ad.	2,184
001 032 060060 00 0 X	60X25-40-60 MM (SİDEM) EK PARÇA	1	ad.	1,999
<b>80X40 KANAL AKSESUARLARI (SİDEM SERİSİ)</b>				
		TS	CE	
001 028 080040 00 0 X	80X40 MM (SİDEM) İÇ KÖŞE	1	ad.	5,082
001 029 080040 00 0 X	80X40 MM (SİDEM) DIŞ KÖŞE	1	ad.	5,082
001 030 080040 00 0 X	80X40 MM (SİDEM) T PARÇASI	1	ad.	5,082
001 031 080040 00 0 X	80X40 MM (SİDEM) 90 L KÖŞE	1	ad.	5,082
001 033 080040 00 0 X	80X40 MM (SİDEM) UÇ TAPA	1	ad.	2,207
001 032 080040 00 0 X	80X40 MM (SİDEM) EK PARÇA	1	ad.	2,207
<b>80X60 KANAL AKSESUARLARI (SİDEM SERİSİ)</b>				
		TS	CE	
001 028 080060 00 0 X	80X60 MM (SİDEM) İÇ KÖŞE	1	ad.	5,336
001 029 080060 00 0 X	80X60 MM (SİDEM) DIŞ KÖŞE	1	ad.	5,602
001 030 080060 00 0 X	80X60 MM (SİDEM) T PARÇASI	1	ad.	5,660
001 031 080060 00 0 X	80X60 MM (SİDEM) 90 L KÖŞE	1	ad.	5,718
001 033 080060 00 0 X	80X60 MM (SİDEM) UÇ TAPA	1	ad.	2,426
001 032 080060 00 0 X	80X60 MM (SİDEM) EK PARÇA	1	ad.	2,703
<b>100X37 KANAL AKSESUARLARI (SİDEM SERİSİ)</b>				
		TS	CE	
001 028 100037 00 0 X	100X37 MM (SİDEM) İÇ KÖŞE (SABİT)	1	ad.	5,336
001 029 100037 00 0 X	100X37 MM (SİDEM) DIŞ KÖŞE (SABİT)	1	ad.	5,833
001 028 100037 01 0 X	100X37 MM (SİDEM) İÇ KÖŞE (HAREKETLİ)	1	ad.	5,336
001 029 100037 01 0 X	100X37 MM (SİDEM) DIŞ KÖŞE (HAREKETLİ)	1	ad.	5,757
001 030 100037 00 0 X	100X37 MM (SİDEM) T PARÇASI	1	ad.	5,336
001 031 100037 00 0 X	100X37 MM (SİDEM) 90 L KÖŞE	1	ad.	5,336
001 033 100037 00 0 X	100X37 MM (SİDEM) UÇ TAPA	1	ad.	2,461
001 032 100050 00 0 X	100X37-50 MM (SİDEM) EK PARÇA	1	ad.	2,703
<b>100X36 KANAL AKSESUARLARI (SİDEM SERİSİ)</b>				
		TS	CE	
001 028 100036 00 0 X	100X36 MM (SİDEM) İÇ KÖŞE (SABİT)	1	ad.	5,336
001 029 100036 00 0 X	100X36 MM (SİDEM) DIŞ KÖŞE (SABİT)	1	ad.	5,336
001 028 100036 01 0 X	100X36 MM (SİDEM) İÇ KÖŞE (HAREKETLİ)	1	ad.	5,336
001 029 100036 01 0 X	100X36 MM (SİDEM) DIŞ KÖŞE (HAREKETLİ)	1	ad.	5,336
001 030 100036 00 0 X	100X36 MM (SİDEM) T PARÇASI	1	ad.	5,336
001 031 100036 00 0 X	100X36 MM (SİDEM) 90 L KÖŞE	1	ad.	5,833
001 033 100060 00 0 X	100X36-40-48-60 MM (SİDEM) UÇ TAPA	1	ad.	2,564
001 032 100060 00 0 X	100X36-40-48-60 MM (SİDEM) EK PARÇA	1	ad.	1,848

İÇ KÖŞE

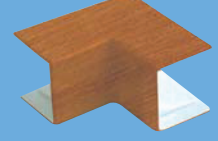

DIŞ KÖŞE

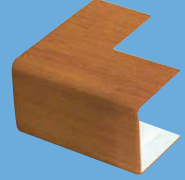

L KÖŞE



T KÖŞE

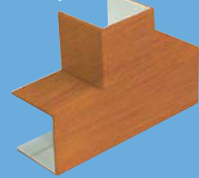

EK PARÇA



UÇ TAPA





Ürün Kodu	Açıklama / Stok Cinsi	Ambalaj (Kutulu)	Ambalaj Birimi	TL
<b>100X40 KANAL AKSESUARLARI (SİDEM SERİSİ)</b>				
001 028 100040 00 0 X	100X40 MM (SİDEM) İÇ KÖŞE (SABİT)	1	ad.	5,833
001 029 100040 00 0 X	100X40 MM (SİDEM) DIŞ KÖŞE (SABİT)	1	ad.	5,833
001 028 100040 01 0 X	100X40 MM (SİDEM) İÇ KÖŞE (HAREKETLİ)	1	ad.	6,058
001 029 100040 01 0 X	100X40 MM (SİDEM) DIŞ KÖŞE (HAREKETLİ)	1	ad.	5,833
001 030 100040 00 0 X	100X40 MM (SİDEM) T PARÇASI	1	ad.	5,833
001 031 100040 00 0 X	100X40 MM (SİDEM) 90 L KÖŞE	1	ad.	5,833
001 033 100060 00 0 X	100X36-40-48-60 MM (SİDEM) UÇ TAPA	1	ad.	2,564
001 032 100060 00 0 X	100X36-40-48-60 MM (SİDEM) EK PARÇA	1	ad.	1,848
<b>100X48 KANAL AKSESUARLARI (SİDEM SERİSİ)</b>				
001 028 100048 00 0 X	100X48 MM (SİDEM) İÇ KÖŞE (SABİT)	1	ad.	6,376
001 029 100048 00 0 X	100X48 MM (SİDEM) DIŞ KÖŞE (SABİT)	1	ad.	5,891
001 028 100048 01 0 X	100X48 MM (SİDEM) İÇ KÖŞE (HAREKETLİ)	1	ad.	6,815
001 029 100048 01 0 X	100X48 MM (SİDEM) DIŞ KÖŞE (HAREKETLİ)	1	ad.	6,064
001 030 100048 00 0 X	100X48 MM (SİDEM) T PARÇASI	1	ad.	5,891
001 031 100048 00 0 X	100X48 MM (SİDEM) 90 L KÖŞE	1	ad.	5,891
001 033 100060 00 0 X	100X36-40-48-60 MM (SİDEM) EK PARÇA	1	ad.	2,564
001 032 100060 00 0 X	100X36-40-48-60 MM (SİDEM) EK PARÇA	1	ad.	1,848
<b>100X37/50 İÇİN KANAL AKSESUARLARI (SİDEM SERİSİ)</b>				
001 034 400001 00 0 X	100X37/50 İÇİN (SİDEM)45X45 P.M.S.TEKLİ	1	ad.	4,620
001 034 400002 00 0 X	100X37/50 İÇİN (SİDEM)45X45P.M.S.İKİLİ	1	ad.	5,473
001 034 400003 00 0 X	100X37/50 İÇİN (SİDEM)45X45 P.M.S.ÜÇLÜ	1	ad.	6,841
001 034 400004 00 0 X	100X37/50 İÇİN (SİDEM)45X45P.M.S.DÖRTLÜ	1	ad.	8,208
001 034 500001 00 0 X	100X37/50 İÇİN (SİDEM)55X55P.M.S.TEKLİ	1	ad.	4,514
001 034 500002 00 0 X	100X37/50 İÇİN (SİDEM)55X55P.M.S.İKİLİ	1	ad.	5,473
001 034 500003 00 0 X	100X37/50 İÇİN (SİDEM)55X55P.M.S. ÜÇLÜ	1	ad.	6,841
<b>100X50 KANAL AKSESUARLARI (SİDEM SERİSİ)</b>				
001 028 100050 00 0 X	100X50-41 MM (SİDEM) İÇ KÖŞE (SABİT)	1	ad.	6,503
001 029 100050 00 0 X	100X50-41 MM (SİDEM) DIŞ KÖŞE (SABİT)	1	ad.	5,949
001 028 100050 01 0 X	100X50-41-37 MM (SİDEM) İÇ KÖŞE (HAREKETLİ)	1	ad.	5,949
001 029 100050 01 0 X	100X50-41-37 MM (SİDEM) DIŞ KÖŞE (HAREKETLİ)	1	ad.	6,064
001 030 100050 00 0 X	100X50-41 MM (SİDEM) T KÖŞE	1	ad.	5,949
001 031 100050 00 0 X	100X50-41 MM (SİDEM) 90 L KÖŞE	1	ad.	5,949
001 033 100050 00 0 X	100X50-41 MM (SİDEM) UÇ TAPA	1	ad.	2,923
001 032 100050 00 0 X	100X50-37 MM (SİDEM) EK PARÇA	1	ad.	2,703
<b>100X60 KANAL AKSESUARLARI (SİDEM SERİSİ)</b>				
001 028 100060 00 0 X	100X60 MM (SİDEM) İÇ KÖŞE (SABİT)	1	ad.	6,503
001 029 100060 00 0 X	100X60 MM (SİDEM) DIŞ KÖŞE (SABİT)	1	ad.	6,503
001 028 100060 01 0 X	100X60 MM (SİDEM) İÇ KÖŞE (HAREKETLİ)	1	ad.	6,815
001 029 100060 01 0 X	100X60 MM (SİDEM) DIŞ KÖŞE (HAREKETLİ)	1	ad.	6,445
001 030 100060 00 0 X	100X60 MM (SİDEM) T PARÇASI	1	ad.	6,295
001 031 100060 00 0 X	100X60 MM (SİDEM) 90 L KÖŞE	1	ad.	5,636
001 033 100060 00 0 X	100X36-40-48-60 MM (SİDEM) UÇ TAPA	1	ad.	2,564
001 032 100060 00 0 X	100X36-40-48-60 MM (SİDEM) EK PARÇA	1	ad.	1,848
<b>100'LÜK SERİ PRİZ MONTAJ SETLERİ (55X55 İÇİN) (SİDEM SERİSİ)</b>				
001 034 000001 00 0 X	100'LÜK SERİ 55X55 P.M.S.TEKLİ SİDEM	1	ad.	4,736
001 034 000002 00 0 X	100'LÜK SERİ 55X55 P.M.S.İKİLİ SİDEM	1	ad.	6,642
001 034 000003 00 0 X	100'LÜK SERİ 55X55 P.M.S.ÜÇLÜ SİDEM	1	ad.	8,374
<b>100'LÜK SERİ PRİZ MONTAJ SETLERİ (45X45 İÇİN)(SİDEM SERİSİ)</b>				
001 034 100001 00 0 X	100'LÜK SERİ 45X45 P.M.S.TEKLİ SİDEM	1	ad.	4,514
001 034 100002 00 0 X	100'LÜK SERİ 45X45 P.M.S.İKİLİ SİDEM	1	ad.	5,473
001 034 100003 00 0 X	100'LÜK SERİ 45X45 P.M.S.ÜÇLÜ SİDEM	1	ad.	6,841
001 034 100004 00 0 X	100'LÜK SERİ 45X45 P.M.S.DÖRTLÜ SİDEM	1	ad.	8,208
<b>120X60 KANAL AKSESUARLARI (SİDEM SERİSİ)</b>				
001 028 120060 00 0 X	120X60 MM (SİDEM) İÇ KÖŞE	1	ad.	8,201
001 029 120060 00 0 X	120X60 MM (SİDEM) DIŞ KÖŞE	1	ad.	6,841
001 030 120060 00 0 X	120X60 MM (SİDEM) T PARÇA	1	ad.	6,841
001 031 120060 00 0 X	120X60 MM (SİDEM) 90 L KÖŞE	1	ad.	6,841
001 034 300001 00 0 X	120X60 MM (SİDEM) P.MONTAJ ÇERV.TEKLİ	1	ad.	6,584
001 034 300002 00 0 X	120X60 MM (SİDEM) P.MONTAJ ÇERV.İKİLİ	1	ad.	8,085
001 034 300003 00 0 X	120X60 MM (SİDEM) P.MONTAJ ÇERV.ÜÇLÜ	1	ad.	9,101
001 033 120060 00 0 X	120X60 MM (SİDEM) UÇ TAPA	1	ad.	3,662
001 032 120060 00 0 X	120X60 MM (SİDEM) EK PARÇA	1	ad.	2,772

Ürün Kodu	Açıklama / Stok Cinsi	Ambalaj (Kutu/Bağ)	Ambalaj (Koli/Çuval)	TL	
<b>EKO SERİSİ PLASTİK SİRALER (SİYAH)</b>					
001 020 401011 00 11	11 Q PLASTİK SİRAL (SİYAH) EKO	100 mt.	1000	0,357	
001 020 401014 00 11	14 Q PLASTİK SİRAL (SİYAH) EKO	100 mt.	1000	0,357	
001 020 401018 00 11	18 Q PLASTİK SİRAL (SİYAH) EKO	100 mt.	1000	0,506	
001 020 401020 00 11	20 Q PLASTİK SİRAL (SİYAH) EKO	100 mt.	1000	0,506	
001 020 401026 00 11	26 Q PLASTİK SİRAL (SİYAH) EKO	50 mt.	500	0,685	
001 020 401032 00 11	32 Q PLASTİK SİRAL (SİYAH) EKO	50 mt.	500	0,935	
<b>MEKS SERİSİ PLASTİK SİRALER (SİYAH)</b>					
001 020 400014 00 11	14 Q PLASTİK SİRAL (SİYAH)	100 mt.	1000	0,413	
001 020 400016 00 11	16 Q PLASTİK SİRAL (SİYAH)	100 mt.	1000	0,464	
001 020 400018 00 11	18 Q PLASTİK SİRAL (SİYAH)	50 mt.	500	0,607	
001 020 400020 00 11	20 Q PLASTİK SİRAL (SİYAH)	50 mt.	500	0,607	
001 020 400026 00 11	26 Q PLASTİK SİRAL (SİYAH)	50 mt.	250	0,772	
001 020 400032 00 11	32 Q PLASTİK SİRAL (SİYAH)	50 mt.	250	1,031	
001 020 400040 00 11	40 Q PLASTİK SİRAL (SİYAH)	25 mt.	125	1,343	
001 020 400050 00 11	50 Q PLASTİK SİRAL (SİYAH)	25 mt.	125	1,738	
<b>PLASTİK SİRALER (SİYAH) (TELLİ)</b>					
001 020 410014 00 11	14 Q PLASTİK SİRAL (SİYAH) TELLİ	100 mt.	1000	0,494	
001 020 410016 00 11	16 Q PLASTİK SİRAL (SİYAH) TELLİ	100 mt.	1000	0,618	
001 020 410018 00 11	18 Q PLASTİK SİRAL (SİYAH) TELLİ	50 mt.	500	0,641	
001 020 410020 00 11	20 Q PLASTİK SİRAL (SİYAH) TELLİ	50 mt.	500	0,641	
001 020 410026 00 11	26 Q PLASTİK SİRAL (SİYAH) TELLİ	50 mt.	250	0,867	
001 020 410032 00 11	32 Q PLASTİK SİRAL (SİYAH) TELLİ	50 mt.	250	1,060	
001 020 410040 00 11	40 Q PLASTİK SİRAL (SİYAH) TELLİ	25 mt.	125	1,401	
<b>PLASTİK SİRALER (RENKLİ)</b>					
001 020 400011 00 00	11 Q PLS. SİRAL (GRİ - BYZ - KIR - MAVİ)	100 mt.	1000	0,605	
001 020 400014 00 00	14 Q PLS. SİRAL (GRİ - BYZ - KIR - MAVİ)	100 mt.	1000	0,509	
001 020 400016 00 00	16 Q PLS. SİRAL (GRİ - BYZ - KIR - MAVİ)	100 mt.	1000	0,716	
001 020 400018 00 00	18 Q PLS. SİRAL (GRİ - BYZ - KIR - MAVİ)	50 mt.	500	0,832	
001 020 400020 00 00	20 Q PLS. SİRAL (GRİ - BYZ - KIR - MAVİ)	50 mt.	250	0,832	
001 020 400026 00 00	26 Q PLS. SİRAL (GRİ - BYZ - KIR - MAVİ)	50 mt.	250	1,018	
001 020 400032 00 00	32 Q PLS. SİRAL (GRİ - BYZ - KIR - MAVİ)	50 mt.	250	1,774	
001 020 400040 00 00	40 Q PLS. SİRAL (GRİ - BYZ - KIR - MAVİ)	25 mt.	125	1,843	
001 020 400050 00 00	50 Q PLS. SİRAL (GRİ - BYZ - KIR - MAVİ)	25 mt.	125	2,885	
001 020 990016 00 17	16MM SİRAL EK MUFU (GRİ)	200 ad.		0,241	
001 020 990020 00 17	20MM SİRAL EK MUFU (GRİ)	200 ad.		0,287	
001 020 990025 00 17	25MM SİRAL EK MUFU (GRİ)	100 ad.		0,347	
001 020 990032 00 17	32MM SİRAL EK MUFU (GRİ)	200 ad.		0,384	
<b>PP POLYPROPİLEN SİRALER</b>					
		Rakor Ölçüleri			
001 020 160007 00 11	MUT/PP-7 SİRAL BORU	PG7	100 mt.	1000	0,132 EUR.
001 020 160009 00 11	MUT/PP-8,5 SİRAL BORU	PG7	100 mt.	1000	0,165 EUR.
001 020 160010 00 11	MUT/PP-10 SİRAL BORU	PG9	100 mt.	1000	0,176 EUR.
001 020 160012 00 11	MUT/PP-12 SİRAL BORU	PG11	50 mt.	500	0,185 EUR.
001 020 160014 00 11	MUT/PP-14 SİRAL BORU	PG13,5	50 mt.	250	0,247 EUR.
001 020 160017 00 11	MUT/PP-17 SİRAL BORU	PG16	50 mt.	250	0,309 EUR.
001 020 160019 00 11	MUT/PP-19 SİRAL BORU		50 mt.	250	0,371 EUR.
001 020 160023 00 11	MUT/PP-23 SİRAL BORU	PG21	50 mt.	250	0,395 EUR.
001 020 160026 00 11	MUT/PP-26 SİRAL BORU		25 mt.	125	0,433 EUR.
001 020 160029 00 11	MUT/PP-29 SİRAL BORU	PG29	25 mt.	125	0,495 EUR.
001 020 160036 00 11	MUT/PP-36 SİRAL BORU	PG36	25 mt.	125	0,680 EUR.
001 020 160048 00 11	MUT/PP-48 SİRAL BORU	PG48	25 mt.	125	0,989 EUR.
<b>PA6 POLYAMİD SİRALER (ALEV YAYMAYAN)</b>					
		Rakor Ölçüleri			
001 020 170007 00 11	MUT/PA6-7 SİRAL BORU (ALEV YAYMAYAN)	PG7	100 mt.	1000	0,231 EUR.
001 020 170009 00 11	MUT/PA6-8,5 SİRAL BORU (ALEV YAYMAYAN)	PG7	100 mt.	1000	0,259 EUR.
001 020 170010 00 11	MUT/PA6-10 SİRAL BORU (ALEV YAYMAYAN)	PG9	100 mt.	1000	0,325 EUR.
001 020 170012 00 11	MUT/PA6-12 SİRAL BORU (ALEV YAYMAYAN)	PG11	50 mt.	500	0,402 EUR.
001 020 170014 00 11	MUT/PA6-14 SİRAL BORU (ALEV YAYMAYAN)	PG13,5	50 mt.	250	0,572 EUR.
001 020 170017 00 11	MUT/PA6-17 SİRAL BORU (ALEV YAYMAYAN)	PG16	50 mt.	250	0,638 EUR.
001 020 170019 00 11	MUT/PA6-19 SİRAL BORU (ALEV YAYMAYAN)		50 mt.	250	0,693 EUR.
001 020 170023 00 11	MUT/PA6-23 SİRAL BORU (ALEV YAYMAYAN)	PG21	50 mt.	250	0,935 EUR.
001 020 170026 00 11	MUT/PA6-26 SİRAL BORU (ALEV YAYMAYAN)		25 mt.	125	0,990 EUR.
001 020 170029 00 11	MUT/PA6-29 SİRAL BORU (ALEV YAYMAYAN)	PG29	25 mt.	125	1,155 EUR.
001 020 170036 00 11	MUT/PA6-36 SİRAL BORU (ALEV YAYMAYAN)	PG36	25 mt.	125	1,429 EUR.
001 020 170048 00 11	MUT/PA6-48 SİRAL BORU (ALEV YAYMAYAN)	PG48	25 mt.	125	1,661 EUR.

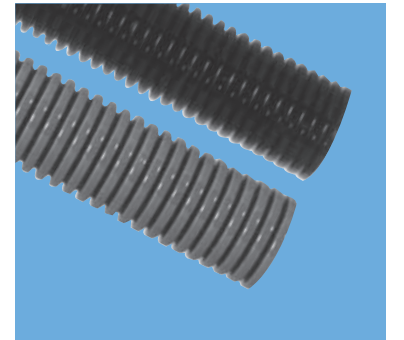
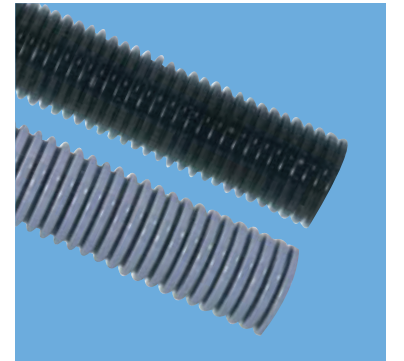
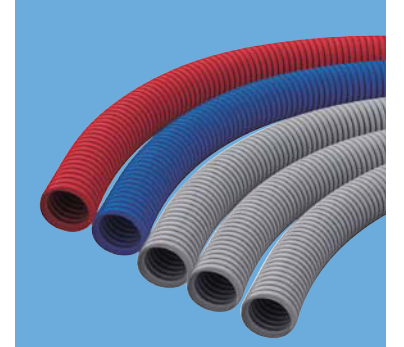

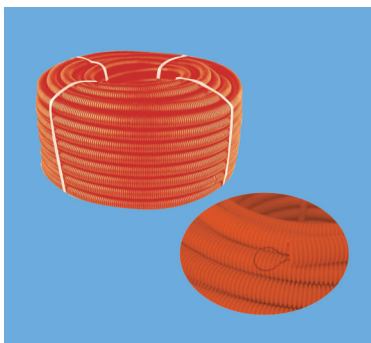
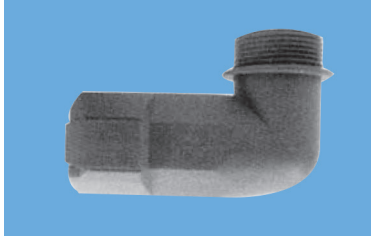
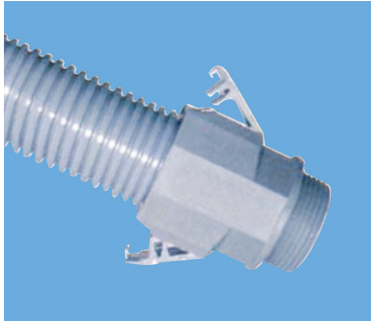

Ürün Kodu	Açıklama / Stok Cinsi	Ambalaj (Kutu/Bağ)	Ambalaj (Koli/Çuval)	TL
<b>POLYAMİD SİRİRAL RAKORU</b>				
057 097 110007	PSR-7 POLYAMİD SİRİRAL REKORU	50 ad.		0,490 EUR.
057 097 110009	PSR-9 POLYAMİD SİRİRAL REKORU	50 ad.		0,523 EUR.
057 097 110011	PSR-11 POLYAMİD SİRİRAL REKORU	50 ad.		0,555 EUR.
057 097 110135	PSR-13,5 POLYAMİD SİRİRAL REKORU	50 ad.		0,588 EUR.
057 097 110016	PSR-16 POLYAMİD SİRİRAL REKORU	25 ad.		0,686 EUR.
057 097 110021	PSR-21 POLYAMİD SİRİRAL REKORU	20 ad.		1,078 EUR.
057 097 110029	PSR-29 POLYAMİD SİRİRAL REKORU	10 ad.		1,862 EUR.
057 097 110036	PSR-36 POLYAMİD SİRİRAL REKORU	1 ad.		2,646 EUR.
057 097 110048	PSR-48 POLYAMİD SİRİRAL REKORU	1 ad.		3,430 EUR.
<b>POLYAMİD SİRİRAL RAKORU (90 DERECE DİRSEK)</b>				
057 097 120007	PSRD-7 POLYAMİD SİRİRAL RAKORU 90 DRC.DİRSEK	1 ad.		0,915 EUR.
057 097 120009	PSRD-9 POLYAMİD SİRİRAL RAKORU 90 DRC.DİRSEK	1 ad.		0,980 EUR.
057 097 120011	PSRD-11 POLYAMİD SİRİRAL RAKORU 90 DRC.DİRSEK	1 ad.		1,078 EUR.
057 097 120135	PSRD-13,5 POLYAMİD SİRİRAL RAKORU 90 DRC.DİRSEK	1 ad.		1,274 EUR.
057 097 120016	PSRD-16 POLYAMİD SİRİRAL RAKORU 90 DRC.DİRSEK	1 ad.		1,470 EUR.
057 097 120021	PSRD-21 POLYAMİD SİRİRAL RAKORU 90 DRC.DİRSEK	1 ad.		2,352 EUR.
057 097 120029	PSRD-29 POLYAMİD SİRİRAL RAKORU 90 DRC.DİRSEK	1 ad.		3,038 EUR.
057 097 120036	PSRD-36 POLYAMİD SİRİRAL RAKORU 90 DRC.DİRSEK	1 ad.		4,116 EUR.
<b>HAFİF SERİ PVC. SİRİRALER (ALEV YAYMAYAN)</b>				
001 020 010016 00 17	16'LİK ALEV YAYMAYAN SİRİRAL (HAFİF SERİ)	100 mt.	500	0,604
001 020 010020 00 17	20'LİK ALEV YAYMAYAN SİRİRAL (HAFİF SERİ)	100 mt.	500	0,852
001 020 010025 00 17	25'LİK ALEV YAYMAYAN SİRİRAL (HAFİF SERİ)	50 mt.	250	1,115
001 020 010032 00 17	32'LİK ALEV YAYMAYAN SİRİRAL (HAFİF SERİ)	50 mt.	250	1,405
<b>AĞIR SERİ PVC. SİRİRALER (ALEV YAYMAYAN) (750N)</b>				
001 020 000016 00 17	16'LİK ALEV YAYMAYAN SİRİRAL (AĞIR SERİ)	100 mt.	500	0,636
001 020 000020 00 17	20'LİK ALEV YAYMAYAN SİRİRAL (AĞIR SERİ)	100 mt.	500	0,898
001 020 000025 00 17	25'LİK ALEV YAYMAYAN SİRİRAL (AĞIR SERİ)	50 mt.	250	1,158
001 020 000032 00 17	32'LİK ALEV YAYMAYAN SİRİRAL (AĞIR SERİ)	50 mt.	250	1,597
<b>HAFİF SERİ PVC. KLAVUZ TELLİ SİRİRALER (ALEV YAYMAYAN)(320N)</b>				
001 020 120016 00 17	16'LİK KLAVUZ TELLİ ALEV YAYMAYAN SİRİRAL (HAFİF SERİ)	100 mt.	500	0,680
001 020 120020 00 17	20'LİK KLAVUZ TELLİ ALEV YAYMAYAN SİRİRAL (HAFİF SERİ)	100 mt.	500	0,896
001 020 120025 00 17	25'LİK KLAVUZ TELLİ ALEV YAYMAYAN SİRİRAL (HAFİF SERİ)	50 mt.	250	1,205
001 020 120032 00 17	32'LİK KLAVUZ TELLİ ALEV YAYMAYAN SİRİRAL (HAFİF SERİ)	50 mt.	250	1,591
<b>AĞIR SERİ PVC. KLAVUZ TELLİ SİRİRALER (ALEV YAYMAYAN)(750N)</b>				
001 020 100016 00 17	16'LİK KLAVUZ TELLİ ALEV YAYMAYAN SİRİRAL (AĞIR SERİ)	100 mt.	500	0,742
001 020 100020 00 17	20'LİK KLAVUZ TELLİ ALEV YAYMAYAN SİRİRAL (AĞIR SERİ)	100 mt.	500	1,051
001 020 100025 00 17	25'LİK KLAVUZ TELLİ ALEV YAYMAYAN SİRİRAL (AĞIR SERİ)	50 mt.	250	1,359
001 020 100032 00 17	32'LİK KLAVUZ TELLİ ALEV YAYMAYAN SİRİRAL (AĞIR SERİ)	50 mt.	250	1,745
<b>HALOJEN FREE SİRİRALER (ALEV YAYAN)(320N)</b>				
001 020 140016 00 12	16'LİK HALOJEN FREE SPR. (ALEV YAYAN)	100 mt.	500	0,544
001 020 140020 00 12	20'LİK HALOJEN FREE SPR. (ALEV YAYAN)	100 mt.	500	0,606
001 020 140025 00 12	25'LİK HALOJEN FREE SPR. (ALEV YAYAN)	50 mt.	250	0,848
001 020 140032 00 12	32'LİK HALOJEN FREE SPR. (ALEV YAYAN)	50 mt.	250	1,175
001 020 140040 00 12	40'LİK HALOJEN FREE SPR. (ALEV YAYAN)	25 mt.	125	1,697
001 020 140050 00 12	50'LİK HALOJEN FREE SPR. (ALEV YAYAN)	25 mt.	125	2,138
<b>HALOJEN FREE SİRİRALER (ALEV YAYAN) TELLİ (320N)</b>				
001 020 141016 00 12	Ø16 H.FREE SİRİRAL(ALEV YAYAN)TELLİ	100 mt.	500	0,635
001 020 141020 00 12	Ø20 H.FREE SİRİRAL(ALEV YAYAN)TELLİ	100 mt.	500	0,724
001 020 141025 00 12	Ø25 H.FREE SİRİRAL(ALEV YAYAN)TELLİ	50 mt.	250	0,979
001 020 141032 00 12	Ø32 H.FREE SİRİRAL(ALEV YAYAN)TELLİ	50 mt.	250	1,264
001 020 141040 00 12	Ø40 H.FREE SİRİRAL(ALEV YAYAN)TELLİ	25 mt.	125	1,827
<b>HALOJEN FREE SİRİRALER (ALEV YAYMAYAN) (320N)</b>				
001 020 150016 00 17	16'LİK HALOJEN FREE SPR. (ALEV YAYMAYAN)	100 mt.	500	0,784
001 020 150020 00 17	20'LİK HALOJEN FREE SPR. (ALEV YAYMAYAN)	100 mt.	500	0,871
001 020 150025 00 17	25'LİK HALOJEN FREE SPR. (ALEV YAYMAYAN)	50 mt.	250	1,199
001 020 150032 00 17	32'LİK HALOJEN FREE SPR. (ALEV YAYMAYAN)	50 mt.	250	1,439
001 020 150040 00 17	40'LİK HALOJEN FREE SPR. (ALEV YAYMAYAN)	25 mt.	125	2,398
001 020 150050 00 17	50'LİK HALOJEN FREE SPR. (ALEV YAYMAYAN)	25 mt.	125	3,021
<b>HALOJEN FREE SİRİRALER (ALEV YAYMAYAN) TELLİ (320N)</b>				
001 020 151016 00 17	Ø16 H.FREE SİRİRAL(A.YAYMAYAN)TELLİ	100 mt.	500	0,879
001 020 151020 00 17	Ø20 H.FREE SİRİRAL(A.YAYMAYAN)TELLİ	100 mt.	500	0,998
001 020 151025 00 17	Ø25 H.FREE SİRİRAL(A.YAYMAYAN)TELLİ	50 mt.	250	1,357
001 020 151032 00 17	Ø32 H.FREE SİRİRAL(A.YAYMAYAN)TELLİ	50 mt.	250	1,597
001 020 151040 00 17	Ø40 H.FREE SİRİRAL(A.YAYMAYAN)TELLİ	25 mt.	125	2,556

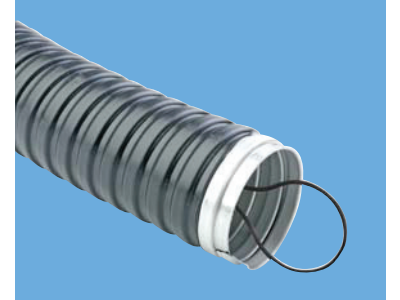
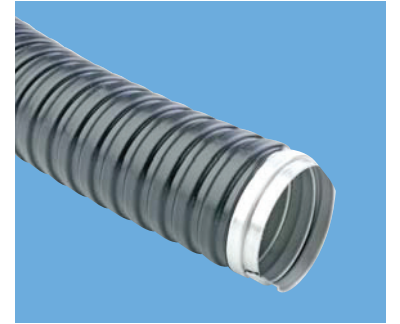
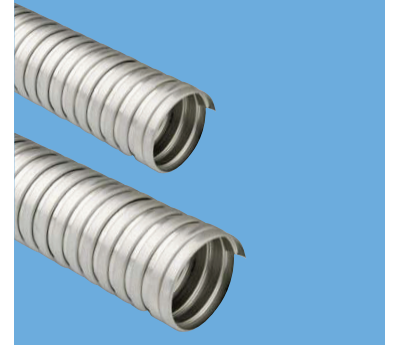
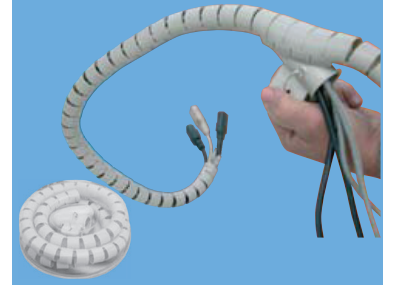

Ürün Kodu	Açıklama / Stok Cinsi	Ambalaj (Kutu/Bağ)	Ambalaj (Koli/Çuval)	TL
<b>KABLO TOPLAMA SİRALI</b>				
888 020 900003	R1034 16 MM KAB.TOP SPR.(1,5M VAK. AMB.)	1 ad.	40	3,360 USD.
888 020 900006	R1035 22 MM KAB.TOP SPR.(1,5M VAK. AMB.)	1 ad.	40	4,572 USD.
888 020 900009	R1036 28 MM KAB.TOP SPR.(1,5M VAK. AMB.)	1 ad.	40	5,806 USD.
888 020 900001	R1033 10 MM KAB.TOP SPR. (25M RULO AMB.)	25 mt.	150	1,665 USD.
888 020 900004	R1034 16 MM KAB.TOP SPR. (25M RULO AMB.)	25 mt.	150	1,860 USD.
888 020 900007	R1035 22 MM KAB.TOP SPR. (25M RULO AMB.)	25 mt.	100	2,595 USD.
888 020 900010	R1036 28 MM KAB.TOP SPR. (25M RULO AMB.)	25 mt.	100	3,388 USD.
888 020 900011	R1037 34 MM KAB.TOP SPR. (25M RULO AMB.)	25 mt.	50	4,241 USD.

HELEZON PANO SİRALI		İÇ ÇAP (mm)	DIŞ ÇAP (mm)			
001 020 500001	NO. 1 HELEZON PANO SİRALI (BOY: 50CM)	5	6	100 ad.	4000	0,184
001 020 500002	NO. 2 HELEZON PANO SİRALI (BOY: 50CM)	7	8	100 ad.	3000	0,232
001 020 500003	NO. 3 HELEZON PANO SİRALI (BOY: 50CM)	10	11	100 ad.	2000	0,360
001 020 500004	NO. 4 HELEZON PANO SİRALI (BOY: 50CM)	13	14	50 ad.	800	0,600
001 020 500005	NO. 5 HELEZON PANO SİRALI (BOY: 50CM)	16	17	50 ad.	800	0,840

HELEZON PANO SİRALI (RULO)		İÇ ÇAP (mm)	DIŞ ÇAP (mm)			
001 020 600001	NO. 1 HELEZON PANO SİRALI (100 MT.LİK RULO)	5	6	100 mt.	500	0,368
001 020 600002	NO. 2 HELEZON PANO SİRALI (100 MT.LİK RULO)	7	8	100 mt.	500	0,464
001 020 600003	NO. 3 HELEZON PANO SİRALI (100 MT.LİK RULO)	10	11	100 mt.	500	0,747
001 020 600004	NO. 4 HELEZON PANO SİRALI (50 MT.LİK RULO)	13	14	50 mt.	250	1,245
001 020 600005	NO. 5 HELEZON PANO SİRALI (50 MT.LİK RULO)	16	17	50 mt.	250	1,702

YENİ

**EKO SERİSİ ÇELİK SİRALER**

001 054 150009 00 66	9 Q ÇELİK SİRAL EKO YENİ	50 mt.	200	0,765
001 054 150011 00 66	11 Q ÇELİK SİRAL EKO (3/8") YENİ	50 mt.	200	0,895
001 054 150014 00 66	14 Q ÇELİK SİRAL EKO (1/2")	50 mt.	200	1,056
001 054 150016 00 66	16 Q ÇELİK SİRAL EKO	50 mt.	200	1,122
001 054 150018 00 66	18 Q ÇELİK SİRAL EKO (3/4")	50 mt.	200	1,240
001 054 150021 00 66	21 Q ÇELİK SİRAL EKO	50 mt.	200	1,374
001 054 150026 00 66	26 Q ÇELİK SİRAL EKO (1")	25 mt.	100	2,153
001 054 150029 00 66	29 Q ÇELİK SİRAL EKO (1 1/4")	25 mt.	100	2,490
001 054 150037 00 66	37 Q ÇELİK SİRAL EKO (1 1/2")	25 mt.	100	3,024
001 054 150042 00 66	42 Q ÇELİK SİRAL EKO	25 mt.	100	3,713
001 054 150050 00 66	50 Q ÇELİK SİRAL EKO (2")	25 mt.	100	4,066

YENİ

**EKO SERİSİ ÇELİK SİRALER (KLAVUZ TELLİ)**

001 054 221011 00 66	11 Q ÇELİK SİRAL EKO (KLAVUZ TELLİ) (3/8")	50 mt.	200	1,078
001 054 221014 00 66	14 Q ÇELİK SİRAL EKO (KLAVUZ TELLİ) (1/2")	50 mt.	200	1,210
001 054 221016 00 66	16 Q ÇELİK SİRAL EKO (KLAVUZ TELLİ)	50 mt.	200	1,298
001 054 221018 00 66	18 Q ÇELİK SİRAL EKO (KLAVUZ TELLİ) (3/4")	50 mt.	200	1,375
001 054 221021 00 66	21 Q ÇELİK SİRAL EKO (KLAVUZ TELLİ)	50 mt.	200	1,595
001 054 221026 00 66	26 Q ÇELİK SİRAL EKO (KLAVUZ TELLİ) (1")	25 mt.	100	2,208
001 054 221029 00 66	29 Q ÇELİK SİRAL EKO (KLAVUZ TELLİ) (1 1/4")	25 mt.	100	2,545
001 054 221037 00 66	37 Q ÇELİK SİRAL EKO (KLAVUZ TELLİ) (1 1/2")	25 mt.	100	3,298
001 054 221042 00 66	42 Q ÇELİK SİRAL EKO (KLAVUZ TELLİ)	25 mt.	100	4,054
001 054 221050 00 66	50 Q ÇELİK SİRAL EKO (KLAVUZ TELLİ) (2")	25 mt.	100	4,121

YENİ

**EKO SERİSİ İZOLELİ ÇELİK SİRALER**

001 054 160009 00 11	9 Q İZOLELİ ÇELİK SİRAL EKO	50 mt.		1,265
001 054 160011 00 11	11 Q İZOLELİ ÇELİK SİRAL EKO (3/8")	50 mt.		1,375
001 054 160014 00 11	14 Q İZOLELİ ÇELİK SİRAL EKO (1/2")	50 mt.		1,540
001 054 160016 00 11	16 Q İZOLELİ ÇELİK SİRAL EKO	50 mt.		1,650
001 054 160018 00 11	18 Q İZOLELİ ÇELİK SİRAL EKO (3/4")	50 mt.		1,925
001 054 160026 00 11	26 Q İZOLELİ ÇELİK SİRAL EKO (1")	25 mt.		2,750
001 054 160029 00 11	29 Q İZOLELİ ÇELİK SİRAL EKO (1 1/4")	25 mt.		3,167
001 054 160037 00 11	37 Q İZOLELİ ÇELİK SİRAL EKO (1 1/2")	25 mt.		4,061
001 054 160042 00 11	42 Q İZOLELİ ÇELİK SİRAL EKO	25 mt.		5,149
001 054 160050 00 11	50 Q İZOLELİ ÇELİK SİRAL EKO (2")	25 mt.		5,583

YENİ

**EKO SERİSİ İZOLELİ ÇELİK SİRALER (KLAVUZ TELLİ)**

001 054 231011 00 11	11 Q İZOLELİ ÇELİK SİRAL EKO (KLAVUZ TELLİ) (3/8")	50 mt.		1,523
001 054 231014 00 11	14 Q İZOLELİ ÇELİK SİRAL EKO (KLAVUZ TELLİ) (1/2")	50 mt.		1,554
001 054 231016 00 11	16 Q İZOLELİ ÇELİK SİRAL EKO (KLAVUZ TELLİ)	50 mt.		1,705
001 054 231018 00 11	18 Q İZOLELİ ÇELİK SİRAL EKO (KLAVUZ TELLİ) (3/4")	50 mt.		1,785
001 054 231026 00 11	26 Q İZOLELİ ÇELİK SİRAL EKO (KLAVUZ TELLİ) (1")	50 mt.		2,678
001 054 231029 00 11	29 Q İZOLELİ ÇELİK SİRAL EKO (KLAVUZ TELLİ) (1 1/4")	25 mt.		3,222
001 054 231037 00 11	37 Q İZOLELİ ÇELİK SİRAL EKO (KLAVUZ TELLİ) (1 1/2")	25 mt.		3,710
001 054 231042 00 11	42 Q İZOLELİ ÇELİK SİRAL EKO (KLAVUZ TELLİ)	25 mt.		5,170
001 054 231050 00 11	50 Q İZOLELİ ÇELİK SİRAL EKO (KLAVUZ TELLİ) (2")	25 mt.		5,800

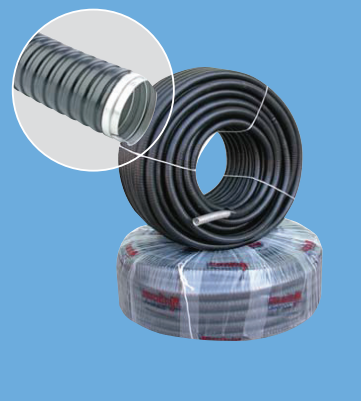
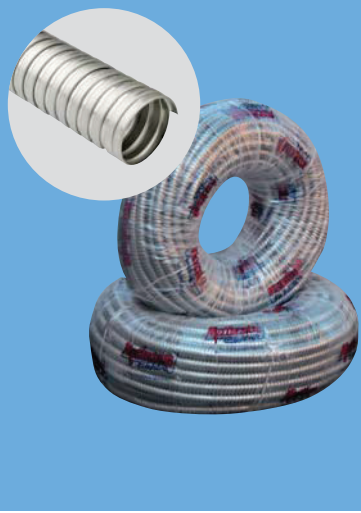

Ürün Kodu	Açıklama / Stok Cinsi	Ambalaj (Kutu/Bağ)	Ambalaj (Koli/Çuval)	TL
-----------	-----------------------	--------------------	----------------------	----

### MEKS SERİSİ ÇELİK SİRALER

001 054 120009 00 66	9 Q ÇELİK SİRAL	TS CE	50 mt.	200	0,990
001 054 120011 00 66	11 Q ÇELİK SİRAL (3/8")	TS CE	50 mt.	200	1,078
001 054 120014 00 66	14 Q ÇELİK SİRAL (1/2")	TS CE	50 mt.	200	1,210
001 054 120016 00 66	16 Q ÇELİK SİRAL	TS CE	50 mt.	200	1,386
001 054 120018 00 66	18 Q ÇELİK SİRAL (3/4")	TS CE	50 mt.	200	1,430
001 054 120021 00 66	21 Q ÇELİK SİRAL	TS CE	50 mt.	200	1,595
001 054 120026 00 66	26 Q ÇELİK SİRAL (1")	TS CE	25 mt.	100	2,300
001 054 120029 00 66	29 Q ÇELİK SİRAL (1 1/4")	TS CE	25 mt.	100	2,769
001 054 120037 00 66	37 Q ÇELİK SİRAL (1 1/2")	TS CE	25 mt.	100	3,355
001 054 120042 00 66	42 Q ÇELİK SİRAL	TS CE	25 mt.	100	4,108
001 054 120050 00 66	50 Q ÇELİK SİRAL (2")	TS CE	25 mt.	100	4,483
001 054 120063 00 66	63 Q ÇELİK SİRAL	TS CE	15 mt.	60	6,353

### MEKS SERİSİ ÇELİK SİRALER (KLAUZ TELLİ)

001 054 121011 00 66	11 Q ÇELİK SİRAL (KLAUZ TELLİ)(3/8")		50 mt.	200	1,272
001 054 121014 00 66	14 Q ÇELİK SİRAL (KLAUZ TELLİ) (1/2")		50 mt.	200	1,438
001 054 121016 00 66	16 Q ÇELİK SİRAL (KLAUZ TELLİ)		50 mt.	200	1,535
001 054 121018 00 66	18 Q ÇELİK SİRAL (KLAUZ TELLİ) (3/4")		25 mt.	100	1,675
001 054 121021 00 66	21 Q ÇELİK SİRAL (KLAUZ TELLİ)		25 mt.	100	1,760
001 054 121026 00 66	26 Q ÇELİK SİRAL (KLAUZ TELLİ) (1")		25 mt.	100	2,461
001 054 121029 00 66	29 Q ÇELİK SİRAL (KLAUZ TELLİ) (1 1/4")		25 mt.	100	2,795
001 054 121037 00 66	37 Q ÇELİK SİRAL (KLAUZ TELLİ) (1 1/2")		25 mt.	100	3,652
001 054 121042 00 66	42 Q ÇELİK SİRAL (KLAUZ TELLİ)		25 mt.	100	4,429
001 054 121050 00 66	50 Q ÇELİK SİRAL (KLAUZ TELLİ) (2")		25 mt.	100	4,565
001 054 121063 00 66	Ø63 ÇELİK SİRAL (KLAUZ TELLİ)		15 mt.	60	6,435

### MEKS SERİSİ İZOLELİ ÇELİK SİRALER

001 054 130009 00 11	9 Q İZOLELİ ÇELİK SİRAL	TS CE	50 mt.		1,395
001 054 130011 00 11	11 Q İZOLELİ ÇELİK SİRAL (3/8")	TS CE	50 mt.		1,521
001 054 130014 00 11	14 Q İZOLELİ ÇELİK SİRAL (1/2")	TS CE	50 mt.		1,663
001 054 130016 00 11	16 Q İZOLELİ ÇELİK SİRAL	TS CE	50 mt.		1,777
001 054 130018 00 11	18 Q İZOLELİ ÇELİK SİRAL (3/4")	TS CE	50 mt.		2,003
001 054 130026 00 11	26 Q İZOLELİ ÇELİK SİRAL (1")	TS CE	25 mt.		2,996
001 054 130029 00 11	29 Q İZOLELİ ÇELİK SİRAL (1 1/4")	TS CE	25 mt.		3,383
001 054 130037 00 11	37 Q İZOLELİ ÇELİK SİRAL (1 1/2")	TS CE	25 mt.		4,045
001 054 130042 00 11	42 Q İZOLELİ ÇELİK SİRAL	TS CE	25 mt.		5,250
001 054 130050 00 11	50 Q İZOLELİ ÇELİK SİRAL (2")	TS CE	25 mt.		6,043
001 054 130063 00 11	Ø63 İZOLELİ ÇELİK SİRAL	TS CE	15 mt.		8,294

### MEKS SERİSİ İZOLELİ ÇELİK SİRALER (KLAUZ TELLİ)

001 054 140011 00 11	11 Q İZOLELİ ÇELİK SİRAL (KLAUZ TELLİ) (1/2")		50 mt.		1,712
001 054 140014 00 11	14 Q İZOLELİ ÇELİK SİRAL (KLAUZ TELLİ) (1/2")		50 mt.		1,740
001 054 140016 00 11	16 Q İZOLELİ ÇELİK SİRAL (KLAUZ TELLİ)		50 mt.		1,865
001 054 140018 00 11	18 Q İZOLELİ ÇELİK SİRAL (KLAUZ TELLİ) (3/4")		50 mt.		2,082
001 054 140026 00 11	26 Q İZOLELİ ÇELİK SİRAL (KLAUZ TELLİ) (1")		25 mt.		3,045
001 054 140029 00 11	29 Q İZOLELİ ÇELİK SİRAL (KLAUZ TELLİ) (1 1/4")		25 mt.		3,366
001 054 140037 00 11	37 Q İZOLELİ ÇELİK SİRAL (KLAUZ TELLİ) (1 1/2")		25 mt.		4,116
001 054 140042 00 11	42 Q İZOLELİ ÇELİK SİRAL (KLAUZ TELLİ)		25 mt.		5,300
001 054 140050 00 11	50 Q İZOLELİ ÇELİK SİRAL (KLAUZ TELLİ) (2")		25 mt.		6,111
001 054 140063 00 11	Ø63 İZOLELİ ÇELİK SİRAL (KLAUZ TELLİ)		15 mt.		8,349

Ürün Kodu	Açıklama / Stok Cinsi	Ambalaj (Kutu/Bağ)	Ambalaj (Koli/Çuval)	TL
<b>SÜPER ETANJ PLASTİK RAKORLAR</b>				
010 097 00007	PG-7 SÜPER ETANJ PLASTİK REKOR	450 ad.	4500	0,446
010 097 00009	PG-9 SÜPER ETANJ PLASTİK REKOR	300 ad.	3000	0,536
010 097 00011	PG-11 SÜPER ETANJ PLASTİK REKOR	200 ad.	2000	0,625
010 097 000135	PG-13,5 SÜPER ETANJ PLASTİK REKOR	175 ad.	1750	0,685
010 097 00016	PG-16 SÜPER ETANJ PLASTİK REKOR	125 ad.	1250	0,804
010 097 00021	PG-21 SÜPER ETANJ PLASTİK REKOR	75 ad.	750	1,131
010 097 00029	PG-29 SÜPER ETANJ PLASTİK REKOR	40 ad.	400	1,845
010 097 00036	PG-36 SÜPER ETANJ PLASTİK REKOR	20 ad.	200	3,479
010 097 00042	PG-42 SÜPER ETANJ PLASTİK REKOR	15 ad.	150	4,538
010 097 00048	PG-48 SÜPER ETANJ PLASTİK REKOR	12 ad.	120	5,143



<b>PLASTİK RAKOR SOMUNLARI</b>				
010 098 020007	PG-7 SOMUN	250 ad.		0,175
010 098 020009	PG-9 SOMUN	250 ad.		0,210
010 098 020011	PG-11 SOMUN	250 ad.		0,210
010 098 020135	PG-13,5 SOMUN	250 ad.		0,245
010 098 020016	PG-16 SOMUN	250 ad.		0,245
010 098 020021	PG-21 SOMUN	250 ad.		0,315
010 098 020029	PG-29 SOMUN	150 ad.		0,524
010 098 020036	PG-36 SOMUN	100 ad.		1,083



<b>KÖR TAPA</b>				
012 098 000007	PG 7 KÖR TAPA	250 ad.		0,333
012 098 000009	PG 9 KÖR TAPA	250 ad.		0,363
012 098 000011	PG 11 KÖR TAPA	250 ad.		0,393
012 098 000135	PG 13,5 KÖR TAPA	250 ad.		0,484
012 098 000016	PG 16 KÖR TAPA	250 ad.		0,605
012 098 000021	PG 21 KÖR TAPA	250 ad.		0,756
012 098 000029	PG 29 KÖR TAPA	150 ad.		1,271
012 098 000036	PG 36 KÖR TAPA	100 ad.		1,815



<b>NİKEL KAPLI ÇELİK SİRİAL RAKORU</b>				
012 097 030009	CLK-9 NİKEL KAPLI ÇELİK SİRİAL RAKORU	150 ad.		5,731
012 097 030011	CLK-11 NİKEL KAPLI ÇELİK SİRİAL RAKORU	175 ad.		7,347
012 097 030014	CLK-14 NİKEL KAPLI ÇELİK SİRİAL RAKORU	90 ad.		8,082
012 097 030016	CLK-16 NİKEL KAPLI ÇELİK SİRİAL RAKORU	75 ad.		9,404
012 097 030018	CLK-18 NİKEL KAPLI ÇELİK SİRİAL RAKORU	80 ad.		11,021
012 097 030026	CLK-26 NİKEL KAPLI ÇELİK SİRİAL RAKORU	30 ad.		14,988
012 097 030037	CLK-37 NİKEL KAPLI ÇELİK SİRİAL RAKORU	9 ad.		32,327

<b>SÜPER ETANJ METAL RAKORLAR</b>				
057 097 100007	PG-7 SÜPER ETANJ METAL RAKOR	1 ad.		4,084
057 097 100009	PG-9 SÜPER ETANJ METAL RAKOR	1 ad.		4,628
057 097 100011	PG-11 SÜPER ETANJ METAL RAKOR	1 ad.		4,991
057 097 100135	PG-13,5 SÜPER ETANJ METAL RAKOR	1 ad.		5,748
057 097 100016	PG-16 SÜPER ETANJ METAL RAKOR	1 ad.		7,411
057 097 100021	PG-21 SÜPER ETANJ METAL RAKOR	1 ad.		11,495
057 097 100029	PG-29 SÜPER ETANJ METAL RAKOR	1 ad.		19,511
057 097 100036	PG-36 SÜPER ETANJ METAL RAKOR	1 ad.		30,250
057 097 100042	PG-42 SÜPER ETANJ METAL RAKOR	1 ad.		45,980
057 097 100048	PG-48 SÜPER ETANJ METAL RAKOR	1 ad.		61,408



<b>PİRİNÇ RAKORLAR (KELEPÇELİ)</b>				
012 097 020009	9'LUK PİRİNÇ RAKOR (KELEPÇELİ)	1 ad.		6,612
012 097 020011	11'LIK PİRİNÇ RAKOR (KELEPÇELİ)	1 ad.		7,788
012 097 020135	13,5'LUK PİRİNÇ RAKOR (KELEPÇELİ)	1 ad.		9,110
012 097 020016	16'LIK PİRİNÇ RAKOR (KELEPÇELİ)	1 ad.		9,992
012 097 020021	21'LIK PİRİNÇ RAKOR (KELEPÇELİ)	1 ad.		13,519
012 097 020029	29'LUK PİRİNÇ RAKOR (KELEPÇELİ)	1 ad.		22,041
012 097 020036	36'LIK PİRİNÇ RAKOR (KELEPÇELİ)	1 ad.		33,062
012 097 020042	42'LIK PİRİNÇ RAKOR (KELEPÇELİ)	1 ad.		44,083



<b>PİRİNÇ RAKORLAR (NORMAL)</b>				
012 097 010009	9'LUK PİRİNÇ RAKOR (NORMAL)	1 ad.		3,674
012 097 010011	11'LIK PİRİNÇ RAKOR (NORMAL)	1 ad.		4,408
012 097 010135	13,5'LUK PİRİNÇ RAKOR (NORMAL)	1 ad.		5,584
012 097 010016	16'LIK PİRİNÇ RAKOR (NORMAL)	1 ad.		6,612
012 097 010021	21'LIK PİRİNÇ RAKOR (NORMAL)	1 ad.		9,992
012 097 010029	29'LUK PİRİNÇ RAKOR (NORMAL)	1 ad.		16,164
012 097 010036	36'LIK PİRİNÇ RAKOR (NORMAL)	1 ad.		22,041
012 097 010042	42'LIK PİRİNÇ RAKOR (NORMAL)	1 ad.		26,450

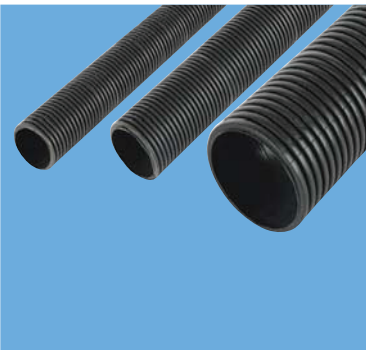

Ürün Kodu	Açıklama / Stok Cinsi	Ambalaj (Kutu/Bağ)	Ambalaj (Koli/Çuval)	TL
-----------	-----------------------	--------------------	----------------------	----

### SİBOR SERİSİ HALOGEN FREE TURUNCU BORULAR ( 6 ATÜ) (ALEV YAYAN)

001 165 706014 00 12	14/6 ATÜ BORU (H.FREE TURUNCU) (ALEV YAYAN) SİBOR SERİSİ	100	mt.	0,632
001 165 706016 00 12	16/6 ATÜ BORU (H.FREE TURUNCU) (ALEV YAYAN) SİBOR SERİSİ	100	mt.	0,766
001 165 706018 00 12	18/6 ATÜ BORU (H.FREE TURUNCU) (ALEV YAYAN) SİBOR SERİSİ	100	mt.	0,922
001 165 706020 00 12	20/6 ATÜ BORU (H.FREE TURUNCU) (ALEV YAYAN) SİBOR SERİSİ	100	mt.	1,035
001 165 706025 00 12	25/6 ATÜ BORU (H.FREE TURUNCU) (ALEV YAYAN) SİBOR SERİSİ	100	mt.	1,366
001 165 706032 00 12	32/6 ATÜ BORU (H.FREE TURUNCU) (ALEV YAYAN) SİBOR SERİSİ	100	mt.	2,132
001 165 706037 00 12	37/6 ATÜ BORU (H.FREE TURUNCU) (ALEV YAYAN) SİBOR SERİSİ	100	mt.	2,723
001 165 706040 00 12	40/6 ATÜ BORU (H.FREE TURUNCU) (ALEV YAYAN) SİBOR SERİSİ	100	mt.	3,157
001 165 706050 00 12	50/6 ATÜ BORU (H.FREE TURUNCU) (ALEV YAYAN) SİBOR SERİSİ	100	mt.	4,422

### SİBOR SERİSİ HALOGEN FREE TURUNCU BORULAR ( 10 ATÜ) (ALEV YAYAN)

001 165 710014 00 12	14/10 ATÜ BORU (H.FREE TURUNCU) (ALEV YAYAN) SİBOR SERİSİ	100	mt.	0,714
001 165 710016 00 12	16/10 ATÜ BORU (H.FREE TURUNCU) (ALEV YAYAN) SİBOR SERİSİ	100	mt.	0,849
001 165 710018 00 12	18/10 ATÜ BORU (H.FREE TURUNCU) (ALEV YAYAN) SİBOR SERİSİ	100	mt.	1,051
001 165 710020 00 12	20/10 ATÜ BORU (H.FREE TURUNCU) (ALEV YAYAN) SİBOR SERİSİ	100	mt.	1,279
001 165 710025 00 12	25/10 ATÜ BORU (H.FREE TURUNCU) (ALEV YAYAN) SİBOR SERİSİ	100	mt.	1,593
001 165 710032 00 12	32/10 ATÜ BORU (H.FREE TURUNCU) (ALEV YAYAN) SİBOR SERİSİ	100	mt.	2,526
001 165 710037 00 12	37/10 ATÜ BORU (H.FREE TURUNCU) (ALEV YAYAN) SİBOR SERİSİ	100	mt.	3,040
001 165 710040 00 12	40/10 ATÜ BORU (H.FREE TURUNCU) (ALEV YAYAN) SİBOR SERİSİ	100	mt.	4,153
001 165 710050 00 12	50/10 ATÜ BORU (H.FREE TURUNCU) (ALEV YAYAN) SİBOR SERİSİ	100	mt.	5,418

### SİBOR SERİSİ HALOGEN FREE BORULAR ( 6 ATÜ) (ALEV YAYMAYAN)

001 165 206014 00 12	14/6 ATÜ BORU (H.FREE TURUNCU) (ALEV YAYMAYAN) SİBOR SERİSİ	100	mt.	1,051
001 165 206016 00 12	16/6 ATÜ BORU (H.FREE TURUNCU) (ALEV YAYMAYAN) SİBOR SERİSİ	100	mt.	1,217
001 165 206018 00 12	18/6 ATÜ BORU (H.FREE TURUNCU) (ALEV YAYMAYAN) SİBOR SERİSİ	100	mt.	1,359
001 165 206020 00 12	20/6 ATÜ BORU (H.FREE TURUNCU) (ALEV YAYMAYAN) SİBOR SERİSİ	100	mt.	1,655
001 165 206025 00 12	25/6 ATÜ BORU (H.FREE TURUNCU) (ALEV YAYMAYAN) SİBOR SERİSİ	100	mt.	2,091
001 165 206032 00 12	32/6 ATÜ BORU (H.FREE TURUNCU) (ALEV YAYMAYAN) SİBOR SERİSİ	100	mt.	3,485
001 165 206037 00 12	37/6 ATÜ BORU (H.FREE TURUNCU) (ALEV YAYMAYAN) SİBOR SERİSİ	100	mt.	4,356
001 165 206040 00 12	40/6 ATÜ BORU (H.FREE TURUNCU) (ALEV YAYMAYAN) SİBOR SERİSİ	100	mt.	4,879
001 165 206050 00 12	50/6 ATÜ BORU (H.FREE TURUNCU) (ALEV YAYMAYAN) SİBOR SERİSİ	100	mt.	7,493

### SİBOR SERİSİ HALOGEN FREE BORULAR ( 10 ATÜ) (ALEV YAYMAYAN)

001 165 210014 00 12	14/10 ATÜ BORU (H.FREE TURUNCU) (ALEV YAYMAYAN) SİBOR SERİSİ	100	mt.	1,133
001 165 210016 00 12	16/10 ATÜ BORU (H.FREE TURUNCU) (ALEV YAYMAYAN) SİBOR SERİSİ	100	mt.	1,359
001 165 210018 00 12	18/10 ATÜ BORU (H.FREE TURUNCU) (ALEV YAYMAYAN) SİBOR SERİSİ	100	mt.	1,655
001 165 210020 00 12	20/10 ATÜ BORU (H.FREE TURUNCU) (ALEV YAYMAYAN) SİBOR SERİSİ	100	mt.	2,091
001 165 210025 00 12	25/10 ATÜ BORU (H.FREE TURUNCU) (ALEV YAYMAYAN) SİBOR SERİSİ	100	mt.	2,440
001 165 210032 00 12	32/10 ATÜ BORU (H.FREE TURUNCU) (ALEV YAYMAYAN) SİBOR SERİSİ	100	mt.	3,834
001 165 210037 00 12	37/10 ATÜ BORU (H.FREE TURUNCU) (ALEV YAYMAYAN) SİBOR SERİSİ	100	mt.	5,228
001 165 210040 00 12	40/10 ATÜ BORU (H.FREE TURUNCU) (ALEV YAYMAYAN) SİBOR SERİSİ	100	mt.	6,273
001 165 210050 00 12	50/10 ATÜ BORU (H.FREE TURUNCU) (ALEV YAYMAYAN) SİBOR SERİSİ	100	mt.	9,061

### HDPE KORUGE BORULAR

096 045 150050	Q50 KORUGE KANGAL BORU	100 mt.		4,016
096 045 150060	Q63 KORUGE KANGAL BORU	100 mt.		4,364
096 045 150075	Q75 KORUGE KANGAL BORU	100 mt.		5,155
096 045 150100	Q100 KORUGE BOY BORU (6 MT.)	6 mt.		6,009
096 045 150115	Q115 KORUGE BOY BORU (6 MT.)	6 mt.		6,483
096 045 150002	Q100 MANŞON	1 ad.		3,045
096 045 150001	Q115 MANŞON	1 ad.		3,361

### HDPE KORUGE BORULAR (TÜRK TELEKOM ONAYLI)

096 045 160050	Q50 KORUGE KANGAL BORU + MANŞON	6 mt.		4,196
096 045 160075	Q75 KORUGE KANGAL BORU +MANŞON	6 mt.		5,136
096 045 150110	Q110 KORUGE KANGAL BORU +MANŞON	6 mt.		7,004

\* TÜRK TELEKOM ONAYLI KORUGE BORULAR PROJE BAZLI SEVKİYATI YAPILMAKTADIR.

Ürün Kodu	Açıklama / Stok Cinsi	Ambalaj (Kutu/Bağ)	Ambalaj (Koli/Çuval)	TL
<b>MEKS SERİSİ HALOGEN FREE TURUNCU BORULAR (6 ATÜ) (ALEV YAYAN)</b>				
001 165 506014 00 12	14/6 ATÜ BORU (H.FREE TURUNCU) (ALEV YAYAN)		100mt.	0,665
001 165 506016 00 12	16/6 ATÜ BORU (H.FREE TURUNCU) (ALEV YAYAN)	CE	300mt.	0,806
001 165 506018 00 12	18/6 ATÜ BORU (H.FREE TURUNCU) (ALEV YAYAN)		100mt.	0,970
001 165 506020 00 12	20/6 ATÜ BORU (H.FREE TURUNCU) (ALEV YAYAN)	CE	100mt.	1,089
001 165 506025 00 12	25/6 ATÜ BORU (H.FREE TURUNCU) (ALEV YAYAN)	CE	100mt.	1,438
001 165 506032 00 12	32/6 ATÜ BORU (H.FREE TURUNCU) (ALEV YAYAN)	CE	100mt.	2,244
001 165 506037 00 12	37/6 ATÜ BORU (H.FREE TURUNCU) (ALEV YAYAN)		100mt.	2,866
001 165 506040 00 12	40/6 ATÜ BORU (H.FREE TURUNCU) (ALEV YAYAN)	CE	100mt.	3,323
001 165 506050 00 12	50/6 ATÜ BORU (H.FREE TURUNCU) (ALEV YAYAN)	CE	100mt.	4,654
001 165 506063 00 12	63/6 ATÜ BORU (H.FREE TURUNCU) (ALEV YAYAN)	CE	100mt.	7,268
001 165 506075 00 12	75/6 ATÜ BORU (H.FREE TURUNCU) (ALEV YAYAN)	CE	100mt.	9,172
001 165 506090 00 12	90/6 ATÜ BORU (H.FREE TURUNCU) (ALEV YAYAN)		75mt.	13,857

<b>MEKS SERİSİ HALOGEN FREE TURUNCU BORULAR (10 ATÜ) (ALEV YAYAN)</b>				
001 165 510014 00 12	14/10 ATÜ BORU (H.FREE TURUNCU) (ALEV YAYAN)		100mt.	0,751
001 165 510016 00 12	16/10 ATÜ BORU (H.FREE TURUNCU) (ALEV YAYAN)	CE	300mt.	0,894
001 165 510018 00 12	18/10 ATÜ BORU (H.FREE TURUNCU) (ALEV YAYAN)		100mt.	1,107
001 165 510020 00 12	20/10 ATÜ BORU (H.FREE TURUNCU) (ALEV YAYAN)	CE	100mt.	1,346
001 165 510025 00 12	25/10 ATÜ BORU (H.FREE TURUNCU) (ALEV YAYAN)	CE	100mt.	1,677
001 165 510032 00 12	32/10 ATÜ BORU (H.FREE TURUNCU) (ALEV YAYAN)	CE	100mt.	2,659
001 165 510037 00 12	37/10 ATÜ BORU (H.FREE TURUNCU) (ALEV YAYAN)		100mt.	3,200
001 165 510040 00 12	40/10 ATÜ BORU (H.FREE TURUNCU) (ALEV YAYAN)	CE	100mt.	4,372
001 165 510050 00 12	50/10 ATÜ BORU (H.FREE TURUNCU) (ALEV YAYAN)	CE	100mt.	5,704
001 165 510063 00 12	63/10 ATÜ BORU (H.FREE TURUNCU) (ALEV YAYAN)	CE	100mt.	8,262
001 165 510075 00 12	75/10 ATÜ BORU (H.FREE TURUNCU) (ALEV YAYAN)	CE	100mt.	9,758
001 165 510090 00 12	90/10 ATÜ BORU (H.FREE TURUNCU) (ALEV YAYAN)		75mt.	16,099
001 165 510100 00 12	100/10 ATÜ BORU (H.FREE TURUNCU) (ALEV YAYAN)		50mt.	19,965
001 165 510110 00 12	110/10 ATÜ BORU (H.FREE TURUNCU) (ALEV YAYAN)		50mt.	22,205

<b>MEKS SERİSİ HALOGEN FREE BORULAR (6 ATÜ) (ALEV YAYMAYAN)</b>				
001 165 106014 00 12	14/6 ATÜ BORU (H.FREE TURUNCU) (ALEV YAYMAYAN)		100mt.	1,107
001 165 106016 00 12	16/6 ATÜ BORU (H.FREE TURUNCU) (ALEV YAYMAYAN)	CE	100mt.	1,281
001 165 106018 00 12	18/6 ATÜ BORU (H.FREE TURUNCU) (ALEV YAYMAYAN)		100mt.	1,431
001 165 106020 00 12	20/6 ATÜ BORU (H.FREE TURUNCU) (ALEV YAYMAYAN)	CE	100mt.	1,743
001 165 106025 00 12	25/6 ATÜ BORU (H.FREE TURUNCU) (ALEV YAYMAYAN)	CE	100mt.	2,201
001 165 106032 00 12	32/6 ATÜ BORU (H.FREE TURUNCU) (ALEV YAYMAYAN)	CE	100mt.	3,669
001 165 106037 00 12	37/6 ATÜ BORU (H.FREE TURUNCU) (ALEV YAYMAYAN)		100mt.	4,586
001 165 106040 00 12	40/6 ATÜ BORU (H.FREE TURUNCU) (ALEV YAYMAYAN)	CE	100mt.	5,136
001 165 106050 00 12	50/6 ATÜ BORU (H.FREE TURUNCU) (ALEV YAYMAYAN)	CE	100mt.	7,887
001 165 106063 00 12	63/6 ATÜ BORU (H.FREE TURUNCU) (ALEV YAYMAYAN)	CE	100mt.	12,009
001 165 106075 00 12	75/6 ATÜ BORU (H.FREE TURUNCU) (ALEV YAYMAYAN)	CE	100mt.	15,591
001 165 106090 00 12	90/6 ATÜ BORU (H.FREE TURUNCU) (ALEV YAYMAYAN)		75mt.	22,011

<b>MEKS SERİSİ HALOGEN FREE BORULAR (10 ATÜ) (ALEV YAYMAYAN)</b>				
001 165 110014 00 12	14/10 ATÜ BORU (H.FREE TURUNCU) (ALEV YAYMAYAN)		100mt.	1,192
001 165 110016 00 12	16/10 ATÜ BORU (H.FREE TURUNCU) (ALEV YAYMAYAN)	CE	100mt.	1,431
001 165 110018 00 12	18/10 ATÜ BORU (H.FREE TURUNCU) (ALEV YAYMAYAN)		100mt.	1,743
001 165 110020 00 12	20/10 ATÜ BORU (H.FREE TURUNCU) (ALEV YAYMAYAN)	CE	100mt.	2,201
001 165 110025 00 12	25/10 ATÜ BORU (H.FREE TURUNCU) (ALEV YAYMAYAN)	CE	100mt.	2,568
001 165 110032 00 12	32/10 ATÜ BORU (H.FREE TURUNCU) (ALEV YAYMAYAN)	CE	100mt.	4,035
001 165 110037 00 12	37/10 ATÜ BORU (H.FREE TURUNCU) (ALEV YAYMAYAN)		100mt.	5,503
001 165 110040 00 12	40/10 ATÜ BORU (H.FREE TURUNCU) (ALEV YAYMAYAN)	CE	100mt.	6,603
001 165 110050 00 12	50/10 ATÜ BORU (H.FREE TURUNCU) (ALEV YAYMAYAN)	CE	100mt.	9,538
001 165 110063 00 12	63/10 ATÜ BORU (H.FREE TURUNCU) (ALEV YAYMAYAN)	CE	100mt.	14,359
001 165 110075 00 12	75/10 ATÜ BORU (H.FREE TURUNCU) (ALEV YAYMAYAN)	CE	100mt.	18,276
001 165 110090 00 12	90/10 ATÜ BORU (H.FREE TURUNCU) (ALEV YAYMAYAN)		75mt.	26,597
001 165 110100 00 12	100/10 ATÜ BORU (H.FREE TURUNCU) (ALEV YAYMAYAN)		50mt.	34,466
001 165 110110 00 12	110/10 ATÜ BORU (H.FREE TURUNCU) (ALEV YAYMAYAN)		50mt.	37,594



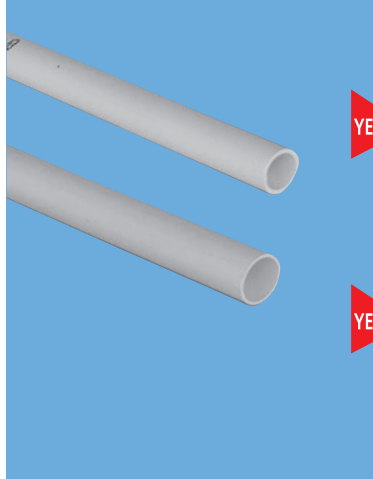

Ürün Kodu	Açıklama / Stok Cinsi	Ambalaj (Kutu/Bağ)	Ambalaj (Koli/Çuval)	TL
<b>POLİETİLEN SİYAH YERALTI BORULAR (450N)</b>				
001 165 406014 00 11	14/6 ATÜ POLİETİLEN BORU (SİYAH)	100 mt.		0,570
001 165 406016 00 11	16/6 ATÜ POLİETİLEN BORU (SİYAH)	100 mt.		0,704
001 165 406018 00 11	18/6 ATÜ POLİETİLEN BORU (SİYAH)	100 mt.		0,816
001 165 406020 00 11	20/6 ATÜ POLİETİLEN BORU (SİYAH)	100 mt.		0,970
001 165 406025 00 11	25/6 ATÜ POLİETİLEN BORU (SİYAH)	100 mt.	CE	1,301
001 165 406032 00 11	32/6 ATÜ POLİETİLEN BORU (SİYAH)	100 mt.	CE	2,039
001 165 406037 00 11	37/6 ATÜ POLİETİLEN BORU (SİYAH)	100 mt.		2,398
001 165 406040 00 11	40/6 ATÜ POLİETİLEN BORU (SİYAH)	100 mt.	CE	2,640
001 165 406050 00 11	50/6 ATÜ POLİETİLEN BORU (SİYAH)	100 mt.	CE	3,944
001 165 406063 00 11	63/6 ATÜ POLİETİLEN BORU (SİYAH)	100 mt.	CE	6,103
001 165 406075 00 11	75/6 ATÜ POLİETİLEN BORU (SİYAH)	100 mt.	CE	8,033
001 165 406090 00 11	90/6 ATÜ POLİETİLEN BORU (SİYAH)	75 mt.	CE	11,226
<b>POLİETİLEN SİYAH YER ALTI BORULAR (750N)</b>				
001 165 410014 00 11	14/10 ATÜ POLİETİLEN BORU (SİYAH)	100 mt.		0,693
001 165 410016 00 11	16/10 ATÜ POLİETİLEN BORU (SİYAH)	100 mt.		0,813
001 165 410018 00 11	18/10 ATÜ POLİETİLEN BORU (SİYAH)	100 mt.		0,939
001 165 410020 00 11	20/10 ATÜ POLİETİLEN BORU (SİYAH)	100 mt.		1,144
001 165 410025 00 11	25/10 ATÜ POLİETİLEN BORU (SİYAH)	100 mt.	CE	1,503
001 165 410032 00 11	32/10 ATÜ POLİETİLEN BORU (SİYAH)	100 mt.	CE	2,169
001 165 410037 00 11	37/10 ATÜ POLİETİLEN BORU (SİYAH)	100 mt.		2,806
001 165 410040 00 11	40/10 ATÜ POLİETİLEN BORU (SİYAH)	100 mt.	CE	3,302
001 165 410050 00 11	50/10 ATÜ POLİETİLEN BORU (SİYAH)	100 mt.	CE	4,769
001 165 410063 00 11	63/10 ATÜ POLİETİLEN BORU (SİYAH)	100 mt.	CE	6,906
001 165 410075 00 11	75/10 ATÜ POLİETİLEN BORU (SİYAH)	100 mt.	CE	8,556
001 165 410090 00 11	90/10 ATÜ POLİETİLEN BORU (SİYAH)	75 mt.	CE	13,631
001 165 410100 00 11	100/10 ATÜ POLİETİLEN BORU (SİYAH)	50 mt.		16,869
001 165 410110 00 11	110/10 ATÜ POLİETİLEN BORU (SİYAH)	50 mt.	CE	19,280
<b>PLASTİK BORULAR</b>				
001 045 000014 30 00	14 MM KALIN BOY BORU	102 mt.	510	0,500
001 045 000018 30 00	18 MM KALIN BOY BORU	102 mt.	510	0,672
001 045 000026 30 00	26 MM KALIN BOY BORU	51 mt.	255	1,222
001 045 000037 30 00	37 MM KALIN BOY BORU	30 mt.		2,335
001 045 010014 00 11	14 MM KANGAL (NORMAL)	100 mt.		0,497
001 045 010018 00 11	18 MM KANGAL (NORMAL)	100 mt.		0,672
001 045 010026 00 11	26 MM KANGAL (NORMAL)	50 mt.		1,217
001 045 010037 00 11	37 MM KANGAL (NORMAL)	50 mt.		2,668
001 045 020014 00 00	14 MM KANGAL (KAUÇUK)	100 mt.		0,491
001 045 020018 00 00	18 MM KANGAL (KAUÇUK)	100 mt.		0,681
001 045 020026 00 00	26 MM KANGAL (KAUÇUK)	50 mt.		1,217
001 045 020037 00 00	37 MM KANGAL (KAUÇUK)	50 mt.		2,569
001 045 030014 00 00	14 MM KANGAL (KAUÇUK) (KALIN)	100 mt.		0,609
001 045 030018 00 00	18 MM KANGAL (KAUÇUK) (KALIN)	100 mt.		0,844
<b>PLASTİK DİRSEK VE MUFLAR</b>				
127 051 000014	PLASTİK 14 Q DİRSEK	100 ad.	2000	0,155
127 051 000018	PLASTİK 18 Q DİRSEK	100 ad.	1000	0,189
127 051 000026	PLASTİK 26 Q DİRSEK	100 ad.	500	0,258
001 051 020014 00 11	PLASTİK 14 Q MUF		1500	0,146
001 051 020018 00 11	PLASTİK 18 Q MUF		1000	0,183
001 051 020026 00 11	PLASTİK 26 Q MUF		500	0,214
001 051 020037 00 11	PLASTİK 37 Q MUF		250	0,265
<b>H.FREE ALEV YAYMAYAN BORULAR (320N)</b>				
001 045 500016 30 17	Ø16/320N (H.FREE)(A.YAYMAYAN)BOY BORU (3M)(GRİ)	102 mt.		3,000
001 045 500020 30 17	Ø20/320N (H.FREE)(A.YAYMAYAN)BOY BORU (3M)(GRİ)	102 mt.		4,430
001 045 500025 30 17	Ø25/320N (H.FREE)(A.YAYMAYAN)BOY BORU (3M)(GRİ)	51 mt.		5,660
001 045 500032 30 17	Ø32/320N (H.FREE)(A.YAYMAYAN)BOY BORU (3M)(GRİ)	30 mt.		7,710
001 045 500040 30 17	Ø40/320N (H.FREE)(A.YAYMAYAN)BOY BORU (3M)(GRİ)	30 mt.		11,300
001 045 500050 30 17	Ø50/320N (H.FREE)(A.YAYMAYAN)BOY BORU (3M)(GRİ)	30 mt.		23,390
<b>H.FREE ALEV YAYMAYAN BORULAR (750N)</b>				
001 045 510016 30 17	Ø16/750N (H.FREE)(A.YAYMAYAN)BOY BORU (3M)(GRİ)	102 mt.		3,180
001 045 510020 30 17	Ø20/750N (H.FREE)(A.YAYMAYAN)BOY BORU (3M)(GRİ)	102 mt.		4,610
001 045 510025 30 17	Ø25/750N (H.FREE)(A.YAYMAYAN)BOY BORU (3M)(GRİ)	51 mt.		6,020
001 045 510032 30 17	Ø32/750N (H.FREE)(A.YAYMAYAN)BOY BORU (3M)(GRİ)	30 mt.		8,430
001 045 510040 30 17	Ø40/750N (H.FREE)(A.YAYMAYAN)BOY BORU (3M)(GRİ)	30 mt.		12,730
001 045 510050 30 17	Ø50/750N (H.FREE)(A.YAYMAYAN)BOY BORU (3M)(GRİ)	30 mt.		25,180
<b>H.FREE ALEV YAYMAYAN BORULAR (1250N)</b>				
001 045 520016 30 17	Ø16/1250N (H.FREE)(A.YAYMAYAN)BOY BORU (3M)(GRİ)	102 mt.		3,350
001 045 520020 30 17	Ø20/1250N (H.FREE)(A.YAYMAYAN)BOY BORU (3M)(GRİ)	102 mt.		4,970
001 045 520025 30 17	Ø25/1250N (H.FREE)(A.YAYMAYAN)BOY BORU (3M)(GRİ)	51 mt.		6,380
001 045 520032 30 17	Ø32/1250N (H.FREE)(A.YAYMAYAN)BOY BORU (3M)(GRİ)	30 mt.		9,330
001 045 520040 30 17	Ø40/1250N (H.FREE)(A.YAYMAYAN)BOY BORU (3M)(GRİ)	30 mt.		13,810
001 045 520050 30 17	Ø50/1250N (H.FREE)(A.YAYMAYAN)BOY BORU (3M)(GRİ)	30 mt.		28,410

Ürün Kodu	Açıklama / Stok Cinsi	Ambalaj (Kutu/Bağ)	Ambalaj (Koli/Çuval)	TL
<b>PVC.ALEV YAYMAYAN BORULAR</b>				
001 045 120014 30 17	14'LÜK PVC.ALEV YAYMAYAN BORU (BOY: 3M.)	—	102 mt.	0,819
001 045 120016 30 17	16'LİK PVC.ALEV YAYMAYAN BORU (BOY: 3M.)	—	102 mt.	0,840
001 045 120018 30 17	18'LİK PVC.ALEV YAYMAYAN BORU (BOY: 3M.)	—	102 mt.	1,118
001 045 120020 30 17	20'LİK PVC.ALEV YAYMAYAN BORU (BOY: 3M.)	—	102 mt.	1,334
001 045 120025 30 17	25'LİK PVC.ALEV YAYMAYAN BORU (BOY: 3M.)	—	51 mt.	1,817
001 045 120032 30 17	32'LİK PVC.ALEV YAYMAYAN BORU (BOY: 3M.)	—	30 mt.	2,783
001 045 120040 30 17	40'LİK PVC.ALEV YAYMAYAN BORU (BOY: 3M.)	—	30 mt.	5,051

<b>PVC.ALEV YAYMAYAN KENDİNDEN MUFLU BORULAR</b>				
001 045 110014 30 17	14'LÜK PVC.ALEV YAYMAYAN MUFLU BORU (BOY: 3 M.)	—	102 mt.	1,202
001 045 110016 30 17	16'LİK PVC.ALEV YAYMAYAN MUFLU BORU (BOY: 3 M.)	—	102 mt.	1,256
001 045 110018 30 17	18'LİK PVC.ALEV YAYMAYAN MUFLU BORU (BOY: 3 M.)	—	102 mt.	1,315
001 045 110020 30 17	20'LİK PVC.ALEV YAYMAYAN MUFLU BORU (BOY: 3 M.)	—	102 mt.	1,515
001 045 110025 30 17	25'LİK PVC.ALEV YAYMAYAN MUFLU BORU (BOY: 3 M.)	—	51 mt.	2,091
001 045 110032 30 17	32'LİK PVC.ALEV YAYMAYAN MUFLU BORU (BOY: 3 M.)	—	30 mt.	3,161
001 045 110040 30 17	40'LİK PVC.ALEV YAYMAYAN MUFLU BORU (BOY: 3 M.)	—	30 mt.	5,673

<b>DİRSEK VE MUFLAR ALEV YAYMAYAN</b>				
001 051 010014 00 17	14'LÜK ALEV YAYMAYAN DİRSEK	100 ad.	700	0,454
001 051 010016 00 17	16'LİK ALEV YAYMAYAN DİRSEK	100 ad.	600	0,465
001 051 010018 00 17	18'LİK ALEV YAYMAYAN DİRSEK	100 ad.	400	0,502
001 051 010020 00 17	20'LİK ALEV YAYMAYAN DİRSEK	100 ad.	300	0,662
001 051 010025 00 17	25'LİK ALEV YAYMAYAN DİRSEK	50 ad.	150	0,769
001 051 010032 00 17	32'LİK ALEV YAYMAYAN DİRSEK	50 ad.	100	1,509
001 051 030014 00 17	14-16'LİK ALEV YAYMAYAN MUF	100 ad.	700	0,278
001 051 030018 00 17	18-20'LİK ALEV YAYMAYAN MUF	100 ad.	700	0,331
001 051 030025 00 17	25'LİK ALEV YAYMAYAN MUF	50 ad.	300	0,371
001 051 030032 00 17	32'LİK ALEV YAYMAYAN MUF	50 ad.	200	0,715

<b>GEÇMELİ TİP ANTİGRON BORU KROŞELERİ</b>				
001 048 010016 00 17	16'LİK ANTİGRON BORU KROŞESİ (GEÇMELİ TİP)	100 ad.	2000	0,147
001 048 010018 00 17	18'LİK ANTİGRON BORU KROŞESİ (GEÇMELİ TİP)	100 ad.	4000	0,158
001 048 010020 00 17	20'LİK ANTİGRON BORU KROŞESİ (GEÇMELİ TİP)	100 ad.	1500	0,168
001 048 010025 00 17	25'LİK ANTİGRON BORU KROŞESİ (GEÇMELİ TİP)	100 ad.	1000	0,191
001 048 010032 00 17	32'LİK ANTİGRON BORU KROŞESİ (GEÇMELİ TİP)	100 ad.	800	0,275
001 048 010040 00 17	40'LİK ANTİGRON BORU KROŞESİ (GEÇMELİ TİP)	50 ad.	1000	0,410
074 048 050016	16 LİK ANTİGRON BORU KROŞESİ (GEÇMELİ TİP) KAPAKLI	100 ad.	4000	0,181
074 048 050017	20 LİK ANTİGRON BORU KROŞESİ (GEÇMELİ TİP) KAPAKLI	100 ad.	3000	0,226
074 048 050025	25 LİK ANTİGRON BORU KROŞESİ (GEÇMELİ TİP) KAPAKLI	100 ad.	2500	0,254
074 048 050032	32 LİK ANTİGRON BORU KROŞESİ (GEÇMELİ TİP) KAPAKLI	100 ad.	1500	0,299

<b>YENİ</b>	<b>DÜZ BORU T DİRSEK H. FREE ALEV YAYMAYAN</b>			
999 999 999888	16'LİK DÜZ BORU T DİRSEK H.F A.YAYMAYAN	100 ad.	300	1,480
999 999 999889	20'LİK DÜZ BORU T DİRSEK H.F A.YAYMAYAN	100 ad.	300	1,708
999 999 999890	25'LİK DÜZ BORU T DİRSEK H.F A.YAYMAYAN	100 ad.	300	1,834
999 999 999891	32'LİK DÜZ BORU T DİRSEK H.F A.YAYMAYAN	100 ad.	200	2,277

<b>YENİ</b>	<b>DÜZ BORU REKORU H.FREE ALEV YAYMAYAN</b>			
999 999 999888	16 LİK DÜZ BORU REKORU H.F A.YAYMAYAN	100 ad.	1,630	
999 999 999889	20 LİK DÜZ BORU REKORU H.F A.YAYMAYAN	100 ad.	1,912	
999 999 999890	25 LİK DÜZ BORU REKORU H.F A.YAYMAYAN	100 ad.	2,176	
999 999 999891	32 LİK DÜZ BORU REKORU H.F A.YAYMAYAN	100 ad.	2,721	

<b>YENİ</b>	<b>ANTİGRON BORU KROŞESİ (GEÇMELİ TİP) H.FREE ALEV YAYMAYAN</b>			
001 048 010016 00 17	16 LİK ANT. BORU KR. (GEÇ.TİP) KAPAKLI H.F A.YAYMAYAN	100 ad.	4000	0,329
001 048 010018 00 17	20 LİK ANT. BORU KR. (GEÇ.TİP) KAPAKLI H.F A.YAYMAYAN	100 ad.	3000	0,379
001 048 010020 00 17	25 LİK ANT. BORU KR. (GEÇ.TİP) KAPAKLI H.F A.YAYMAYAN	100 ad.	2500	0,430
001 048 010025 00 17	32 LİK ANT. BORU KR. (GEÇ.TİP) KAPAKLI H.F A.YAYMAYAN	50 ad.	1500	0,495

<b>YENİ</b>	<b>ŞİPRAL REKORU H. FREE ALEV YAYMAYAN</b>			
001 048 010016 00 17	16 LİK ŞİPRAL REKORU KAPAKLI H.FREE A.YAYMAYAN	100 ad.	4000	1,366
001 048 010018 00 17	20 LİK ŞİPRAL REKORU KAPAKLI H.FREE A.YAYMAYAN	100 ad.	3000	1,912
001 048 010020 00 17	25 LİK ŞİPRAL REKORU KAPAKLI H.FREE A.YAYMAYAN	100 ad.	2500	2,454
001 048 010025 00 17	32 LİK ŞİPRAL REKORU KAPAKLI H.FREE A.YAYMAYAN	50 ad.	1500	3,264

Listemizde Olmayan H.Free Aksesuarları için Fiyat alınız

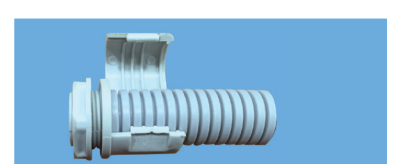
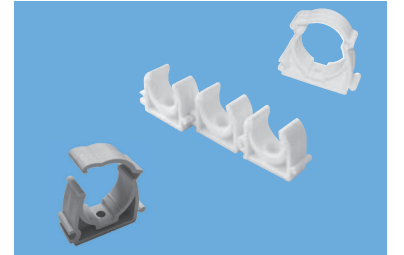
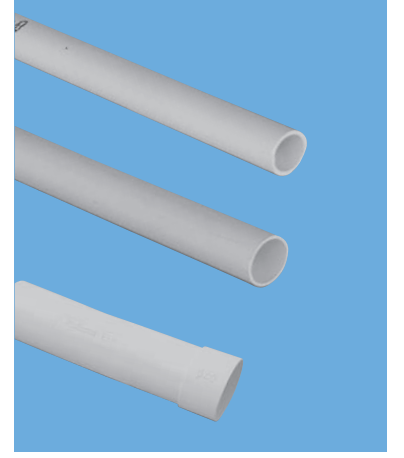

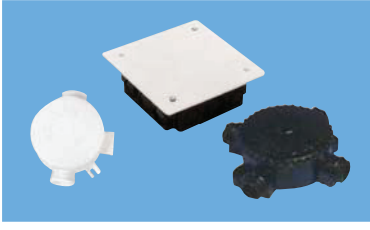

Ürün Kodu	Açıklama / Stok Cinsi	Ambalaj (Kutu/Bağ)	Ambalaj (Koli/Çuval)	TL
<b>PLASTİK KASA-BUAT-TAKOZLAR</b>				
126 046 130103	NORM KASA	100 ad.	1000	0,181
126 046 130104	NORM BUAT (14-18 ÇIKIŞLI)	50 ad.	500	0,363
126 046 130105	NORM BUAT KAPAKSIZ	50 ad.	500	0,298
001 046 160102 00 11	GEÇMELİ PLASTİK KASA	100 ad.	400	0,495
126 046 130106	GEÇMELİ DERİN KASA	100 ad.	500	0,363
126 046 130107	GEÇMELİ DERİN KASA KAPAKSIZ	100 ad.	500	0,281
001 046 120101 00 11	ALÇIPAN KASA 1'Lİ	75 ad.	300	0,913
001 046 120102 00 11	ALÇIPAN KASA 2'Lİ	50 ad.	200	1,502
001 046 120103 00 11	ALÇIPAN KASA 3'Lİ	25 ad.	100	1,883
001 046 120100 00 11	GEÇMELİ ALÇIPAN KASA	50 ad.	300	0,897
001 046 170101 00 11	TÜNEL KASA	100 ad.	500	0,608
001 046 170102 00 11	TÜNEL BUAT	50 ad.	300	0,264
001 046 000001 00 11	PLASTİK TAKOZ (14-18 ÇIKIŞLI)	100 ad.	1000	0,272
<b>TURUNCU KASA VE BUATLAR (ALEV YAYAN)</b>				
001 046 130102 00 12	NORM KASA (TURUNCU) (ALEV YAYAN)	100 ad.	1000	0,297
001 046 130101 00 12	NORM BUAT (TURUNCU) (ALEV YAYAN)	50 ad.	500	0,528
001 046 160102 00 12	GEÇMELİ PLASTİK KASA (TURUNCU) (ALEV YAYAN)	100 ad.	400	0,502
001 046 160101 00 12	GEÇMELİ DERİN KASA (TURUNCU) (ALEV YAYAN)	100 ad.	500	0,528
001 046 170101 00 12	TÜNEL KASA (TURUNCU) (ALEV YAYAN)	100 ad.	500	1,165
001 046 170102 00 12	TÜNEL BUAT (TURUNCU) (ALEV YAYAN)	50 ad.	300	0,979
001 046 120101 00 12	ALÇIPAN KASA 1'Lİ (TURUNCU) (ALEV YAYAN)	75 ad.	300	0,843
001 046 120102 00 12	ALÇIPAN KASA 2'Lİ (TURUNCU) (ALEV YAYAN)	50 ad.	200	1,215
001 046 120103 00 12	ALÇIPAN KASA 3'LÜ (TURUNCU) (ALEV YAYAN)	25 ad.	100	1,753
001 046 120104 00 12	ALÇIPAN KASA 4'LÜ (TURUNCU) (ALEV YAYAN)	28 ad.	100	3,808
001 046 120105 00 12	ALÇIPAN KASA 5'Lİ (TURUNCU) (ALEV YAYAN)	24 ad.	100	4,614
001 046 120106 00 12	ALÇIPAN KASA 6'Lİ (TURUNCU) (ALEV YAYAN)	20 ad.	100	5,507
001 046 120100 00 12	GEÇMELİ ALÇIPAN KASA (TURUNCU)	50 ad.	300	0,956
<b>TURUNCU KASA VE BUATLAR (ALEV YAYMAYAN)</b>				
001 046 131102 00 12	NORM KASA (TURUNCU) (ALEV YAYMAYAN)	100 ad.	500	0,378
001 046 131101 00 12	NORM BUAT (TURUNCU) (ALEV YAYMAYAN)	50 ad.	500	0,630
001 046 161102 00 12	GEÇMELİ PLASTİK KASA (TURUNCU) (ALEV YAYMAYAN)	100 ad.	400	0,546
001 046 161101 00 12	GEÇMELİ DERİN KASA (TURUNCU) (ALEV YAYMAYAN)	100 ad.	500	0,630
001 046 210002 00 12	TÜNEL KASA (TURUNCU) (ALEV YAYMAYAN)	100 ad.	500	1,376
001 046 210003 00 12	TÜNEL BUAT (TURUNCU) (ALEV YAYMAYAN)	50 ad.	300	2,315
001 046 121101 00 12	ALÇIPAN KASA 1'Lİ (TURUNCU) (ALEV YAYMAYAN)	75 ad.	300	1,089
001 046 121102 00 12	ALÇIPAN KASA 2'Lİ (TURUNCU) (ALEV YAYMAYAN)	50 ad.	200	1,499
001 046 121103 00 12	ALÇIPAN KASA 3'LÜ (TURUNCU) (ALEV YAYMAYAN)	25 ad.	100	1,975
001 046 121100 00 12	GEÇMELİ ALÇ.KASA (TURUNCU) (ALEV YAYMAYAN)	50 ad.	300	1,000
<b>KARE BUAT</b>				
001 046 021010 00 11	10X10 KARE BUAT	10 ad.	300	2,174
001 046 021212 00 11	12X12 KARE BUAT	10 ad.	200	2,384
001 046 021515 00 11	15X15 KARE BUAT	10 ad.	120	3,570
001 046 022020 00 11	20X20 KARE BUAT	10 ad.	70	4,904
001 046 000103 00 11	ANTİGRON BUAT 3'LÜ PLASTİK (SİYAH)	10 ad.	240	2,352
001 046 000104 00 11	ANTİGRON BUAT 4'LÜ PLASTİK (SİYAH)	10 ad.	240	2,447
001 046 000103 00 00	ANTİGRON BUAT 3'LÜ PLASTİK (BEYAZ)	10 ad.	240	2,594
001 046 000104 00 00	ANTİGRON BUAT 4'LÜ PLASTİK (BEYAZ)	10 ad.	240	3,045
<b>TURUNCU KARE BUAT</b>				
001 046 021010 00 12	10X10 KARE BUAT TURUNCU	10 ad.	300	2,384
001 046 021212 00 12	12X12 KARE BUAT TURUNCU	10 ad.	200	2,615
001 046 021515 00 12	15X15 KARE BUAT TURUNCU	10 ad.	120	3,626
001 046 022020 00 12	20X20 KARE BUAT TURUNCU	10 ad.	70	4,752
001 046 000103 00 12	ANTİGRON BUAT 3'LÜ TURUNCU	10 ad.	240	2,812
001 046 000104 00 12	ANTİGRON BUAT 4'LÜ TURUNCU	10 ad.	240	3,297
<b>TURUNCU KARE BUAT</b>				
001 046 051010 00 12	KARE BUAT TURUNCU(10X10) (A. YAYMAYAN)	10 ad.	300	3,292
001 046 051212 00 12	KARE BUAT TURUNCU(12X12) (A. YAYMAYAN)	10 ad.	200	3,599
001 046 051515 00 12	KARE BUAT TURUNCU(15X15) (A. YAYMAYAN)	10 ad.	120	4,749
001 046 052020 00 12	KARE BUAT TURUNCU(20X20) (A. YAYMAYAN)	10 ad.	70	6,268
<b>KARE BUAT KAPAKLARI</b>				
000 700 000043 00 00	10X10 KARE BUAT KAPAĞI	1 ad.	300	0,558
000 700 000045 00 00	12X12 KARE BUAT KAPAĞI	1 ad.	200	0,654
000 700 000047 00 00	15X15 KARE BUAT KAPAĞI	1 ad.	200	0,891
000 700 000049 00 00	20X20 KARE BUAT KAPAĞI	1 ad.	100	1,747
<b>LÜX BUAT KAPAKLARI</b>				
126 046 180001	LÜX BUAT KAPAĞI (BOMBELİ-PLASTİK AYAK)	100 ad.	1000	0,248
126 046 180002	LÜX BUAT KAPAĞI (BOMBELİ-SAC AYAK)	100 ad.	1000	0,462
126 046 180003	LÜX BUAT KAPAĞI (DÜZ-PLASTİK AYAK)	100 ad.	1000	0,262
126 046 180004	LÜX BUAT KAPAĞI (BOMB.PLASTİK AYAK)VIDALI	100 ad.	1000	0,400

Ürün Kodu	Açıklama / Stok Cinsi	Ambalaj (Kutu/Bağ)	Ambalaj (Koli/Çuval)	TL
<b>BETON DUVAR ANAHTAR KASALARI (ALEV YAYAN)</b>				
000 700 000037 00 14	BUAT ARKA KAPAK SARI (ALEV YAYAN)	50 ad.	500	0,385
000 700 000035 00 12	BUAT GÖVDE 60'LİK TURUNCU (ALEV YAYAN)	50 ad.	350	0,525
000 700 000256 00 14	KALIBA TESPİT ELEMANI SARI (ALEV YAYAN)		250	0,536
000 700 000039 00 12	SIĞ BRÜT ANAHTAR KASASI TURUNCU (ALEV YAYAN)	100 ad.	500	0,572
000 700 000036 00 14	KONİK GÖVDE SARI (ALEV YAYAN)	50 ad.	250	0,570
000 700 000214 00 14	APLİK 20'LİK SARI (ALEV YAYAN)	100 ad.	1000	0,344
000 700 000215 00 12	APLİK EĞİK BAĞLANTI DİRSEĞİ TURUNCU (ALEV YAYAN)	100 ad.	1000	0,286
<b>BETON DUVAR ANAHTAR KASALARI (ALEV YAYMAYAN)</b>				
000 700 200037 00 14	BUAT ARKA KAPAK SARI (ALEV YAYMAYAN)	50 ad.	500	0,515
000 700 200035 00 12	BUAT GÖVDE 60'LİK TURUNCU (ALEV YAYMAYAN)	50 ad.	350	0,788
000 700 200256 00 14	KALIBA TESPİT ELEMANI SARI (ALEV YAYMAYAN)		250	0,709
000 700 200039 00 12	SIĞ BRÜT ANAHTAR KASASI TURUNCU (ALEV YAYMAYAN)	100 ad.	500	0,861
000 700 200036 00 14	KONİK GÖVDE SARI (ALEV YAYMAYAN)	50 ad.	250	0,656
000 700 200214 00 14	APLİK 20'LİK SARI (ALEV YAYMAYAN)	100 ad.	1000	0,515
000 700 200215 00 12	APLİK EĞİK BAĞLANTI DİRSEĞİ TURUNCU (ALEV YAYMAYAN)	100 ad.	1000	0,431
<b>FİBER SUSTALAR</b>				
999 999 000779	FİBER KLAVUZ 11mm (100mt-120mt-150mt-200mt.)	1 mt		12,137
999 999 000780	FİBER KLAVUZ MAKARASI	1 ad.		569,250
<b>PVC.İZOLE KAPLI ÇELİK SUSTA</b>				
049 019 300010	10 MT. PVC.İZOLE KAPLI ÇELİK SUSTA	1 ad.	30	25,713
049 019 300015	15 MT. PVC.İZOLE KAPLI ÇELİK SUSTA	1 ad.	24	38,569
049 019 300020	20 MT. PVC.İZOLE KAPLI ÇELİK SUSTA	1 ad.	20	51,425
049 019 300025	25 MT. PVC.İZOLE KAPLI ÇELİK SUSTA	1 ad.	18	64,281
<b>PLASTİK SUSTALAR (KILAVUZ TELLİ) BLACK SERİSİ</b>				
049 019 400010	10 MT.KILAVUZ TELLİ PLASTİK SUSTA (BLACK SERİSİ)	10 ad.	80	6,667
049 019 400015	15 MT.KILAVUZ TELLİ PLASTİK SUSTA (BLACK SERİSİ)	8 ad.	64	10,000
049 019 400020	20 MT.KILAVUZ TELLİ PLASTİK SUSTA (BLACK SERİSİ)	6 ad.	48	13,333
049 019 400025	25 MT KILAVUZ TELLİ PLASTİK SUSTA (BLACK SERİSİ)	5 ad.	40	16,667
<b>PLASTİK SUSTALAR (KILAVUZ TELLİ)</b>				
049 019 400010	10 MT.KILAVUZ TELLİ PLASTİK SUSTA	1 ad.	25	10,560
049 019 400015	15 MT.KILAVUZ TELLİ PLASTİK SUSTA	1 ad.	20	15,180
049 019 400020	20 MT.KILAVUZ TELLİ PLASTİK SUSTA	1 ad.	15	20,826
049 019 400025	25 MT KILAVUZ TELLİ PLASTİK SUSTA	1 ad.	15	26,400
<b>ÇELİK SUSTA VE ZİNCİR</b>				
001 019 000010 00 00	SUSTA (1.KALİTE) (10M)	40 ad.	40	11,857
001 019 000015 00 00	SUSTA (1.KALİTE) (15M)	30 ad.	30	17,222
001 019 000020 00 00	SUSTA (1.KALİTE) (20M)	20 ad.	20	22,602
001 019 000025 00 00	SUSTA (1.KALİTE) (25M)	15 ad.	15	27,982
001 019 100010 00 00	TAKVİYELİ SUSTA(1.KALİTE)(10M)	40 ad.	40	14,362
001 019 100015 00 00	TAKVİYELİ SUSTA(1.KALİTE)(15M)	30 ad.	30	20,979
001 019 100020 00 00	TAKVİYELİ SUSTA(1.KALİTE)(20M)	20 ad.	20	27,611
001 019 100025 00 00	TAKVİYELİ SUSTA(1.KALİTE)(25M)	15 ad.	15	34,244
001 018 000001 00 00	FLORESAN ZİNCİRİ	100 mt.	500	0,625
<b>İTHAL SUSTA TABANCASI</b>				
888 888 000700	SUSTA TABANCASI	1 ad.		374,00 EUR.

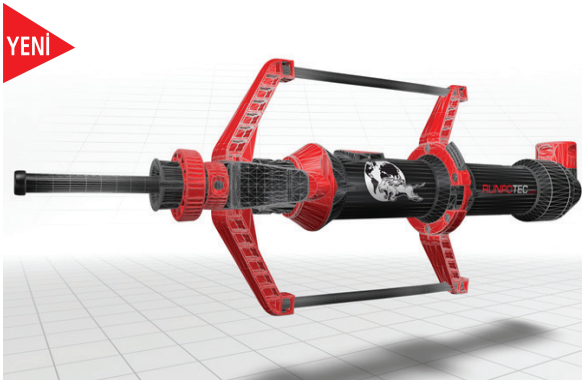
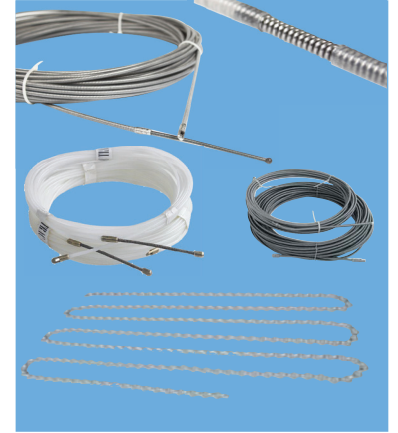
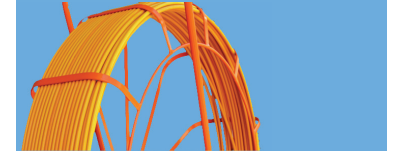
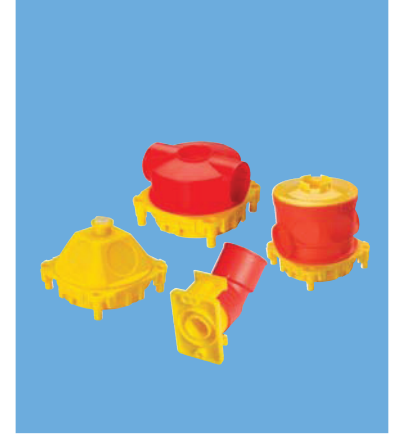



Ürün Kodu	Açıklama / Stok Cinsi	Ambalaj (Kutu/Bağ)	Ambalaj (Koli/Çuval)	TL
<b>MEKSBOX W OTOMAT KUTULARI</b>				
001 027 200001 00 00	MÜHÜRLÜ W OTOMAT KUT.(S/Ü) 1 Lİ	20 ad.	160	1,426
001 027 200002 00 00	MÜHÜRLÜ W OTOMAT KUT.(S/Ü) 2 Lİ	20 ad.	80	1,638
001 027 200004 00 00	MÜHÜRLÜ W OTOMAT KUT.(S/Ü) 4 LÜ	10 ad.	80	3,760
001 027 100002 00 00	W OTOMAT KUT.(S/Ü)MEKSBOX 2 Lİ	1 ad.	30	7,711
001 027 000002 00 00	W OTOMAT KUT.(S/A)MEKSBOX 2 Lİ	1 ad.	30	6,584
001 027 100004 00 00	W OTOMAT KUT.(S/Ü)MEKSBOX 4 LÜ	1 ad.	20	8,265
001 027 000004 00 00	W OTOMAT KUT.(S/A)MEKSBOX 4 LÜ	1 ad.	20	7,435
001 027 100006 00 00	W OTOMAT KUT.(S/Ü)MEKSBOX 6 Lİ	1 ad.	20	11,990
001 027 000006 00 00	W OTOMAT KUT.(S/A)MEKSBOX 6 Lİ	1 ad.	20	11,165
001 027 100009 00 00	W OTOMAT KUT.(S/Ü)MEKSBOX 9 LU	1 ad.	20	15,940
001 027 000009 00 00	W OTOMAT KUT.(S/A)MEKSBOX 9 LU	1 ad.	20	15,598
001 027 100012 00 00	W OTOMAT KUT.(S/Ü)MEKSBOX 12 Lİ	1 ad.	10	18,011
001 027 000012 00 00	W OTOMAT KUT.(S/A)MEKSBOX 12 Lİ	1 ad.	10	17,444
001 027 100016 00 00	W OTOMAT KUT.(S/Ü)MEKSBOX 16 Lİ	1 ad.	10	22,425
001 027 000016 00 00	W OTOMAT KUT.(S/A)MEKSBOX 16 Lİ	1 ad.	10	21,483
001 027 100024 00 00	W OTOMAT KUT.(S/Ü)MEKSBOX 24 LÜ	1 ad.	5	33,007
001 027 000024 00 00	W OTOMAT KUT.(S/A)MEKSBOX 24 LÜ	1 ad.	5	30,813
001 027 100036 00 00	W OTOMAT KUT.(S/Ü)MEKSBOX 36 Lİ	1 ad.	5	43,407
001 027 000036 00 00	W OTOMAT KUT.(S/A)MEKSBOX 36 Lİ	1 ad.	5	42,499
<b>MEKSBOX W OTOMAT KUTULARI (ALEV YAYMAYAN)</b>				
001 027 210001 00 00	MÜH.W OTOMAT KUT.ALEV YAYMAYAN(S/Ü)1 Lİ	20 ad.	160	2,071
001 027 210002 00 00	MÜH.W OTOMAT KUT.ALEV YAYMAYAN(S/Ü)2 Lİ	20 ad.	80	2,911
001 027 210004 00 00	MÜH.W OTOMAT KUT.ALEV YAYMAYAN(S/Ü)4 LÜ	10 ad.	80	6,230
001 027 110002 00 00	W OTOMAT KUT.(S/Ü)ALEV YAYMAYAN 2 Lİ	1 ad.	30	10,009
001 027 010002 00 00	W OTOMAT KUT.(S/A)ALEV YAYMAYAN 2 Lİ	1 ad.	30	9,892
001 027 110004 00 00	W OTOMAT KUT.(S/Ü)ALEV YAYMAYAN 4 LÜ	1 ad.	20	12,737
001 027 010004 00 00	W OTOMAT KUT.(S/A)ALEV YAYMAYAN 4 LÜ	1 ad.	20	12,008
001 027 110006 00 00	W OTOMAT KUT.(S/Ü)ALEV YAYMAYAN 6 Lİ	1 ad.	20	17,361
001 027 010006 00 00	W OTOMAT KUT.(S/A)ALEV YAYMAYAN 6 Lİ	1 ad.	20	14,871
001 027 110009 00 00	W OTOMAT KUT.(S/Ü)ALEV YAYMAYAN 9 LU	1 ad.	20	23,185
001 027 010009 00 00	W OTOMAT KUT.(S/A)ALEV YAYMAYAN 9 LU	1 ad.	20	20,164
001 027 110012 00 00	W OTOMAT KUT.(S/Ü)ALEV YAYMAYAN 12 Lİ	1 ad.	10	27,664
001 027 010012 00 00	W OTOMAT KUT.(S/A)ALEV YAYMAYAN 12 Lİ	1 ad.	10	24,526
001 027 110016 00 00	W OTOMAT KUT.(S/Ü)ALEV YAYMAYAN 16 Lİ	1 ad.	10	33,862
001 027 010016 00 00	W OTOMAT KUT.(S/A)ALEV YAYMAYAN 16 Lİ	1 ad.	10	28,903
001 027 110024 00 00	W OTOMAT KUT.(S/Ü)ALEV YAYMAYAN 24 LÜ	1 ad.	5	49,414
001 027 010024 00 00	W OTOMAT KUT.(S/A)ALEV YAYMAYAN 24 LÜ	1 ad.	5	41,873
001 027 110036 00 00	W OTOMAT KUT.(S/Ü)ALEV YAYMAYAN 36 Lİ	1 ad.	5	70,689
001 027 010036 00 00	W OTOMAT KUT.(S/A)ALEV YAYMAYAN 36 Lİ	1 ad.	5	70,435
<b>ÖRTME PARÇALARI</b>				
001 026 000002 00 00	W OTOMAT ÖRTME PARÇASI (12'Lİ) YENİ TİP	50 ad.	400	0,882
<b>SAYAÇ KUTULARI</b>				
047 089 010855	MONOFAZE MODÜLER SAYAÇ KUTUSU(215X405X115) MM	1 ad.		56,548
047 089 010856	TRİFAZE SAYAÇ KUTUSU(540X350X130) MM	1 ad.		88,281
047 089 010843	LÜKS MONOFAZE DİJİTAL SAYAÇ KUTUSU	1 ad.		23,762
047 089 010844	LÜKS MONOFAZE DİJİTAL MEKANİK SAYAÇ KUTUSU	1 ad.		24,063
047 089 010845	LÜKS MONOFAZE DİJİTAL MEKANİK SAYAÇ KUTUSU S/A	1 ad.		24,664
047 089 010841	LÜKS TRİFAZE DİJİTAL MEKANİK SAYAÇ KUTUSU	1 ad.		37,448

Ürün Kodu	Açıklama / Stok Cinsi	Ambalaj (Kutu/Bağ)	Ambalaj (Koli/Çuval)	TL
<b>PLASTİK ZAYIF AKIM KUTUSU (TABAN SAÇLI)</b>				
888 111 000001	ZAYIF AKIM KUTUSU KOMPLE MODÜLLÜ (SAÇ)	1 ad.		92,400
097 130 012230	SIVA ALTI PLS.ZAYIF AKIM KUTUSU (TABAN SAÇLI) 22X30 CM.	1 ad.		46,945
097 130 022230	SIVA ÜSTÜ PLS.ZAYIF AKIM KUTUSU (TABAN SAÇLI) 22X30 CM.	1 ad.		52,848
097 130 013530	SIVA ALTI PLS.ZAYIF AKIM KUTUSU (TABAN SAÇLI) 35X30 CM.	1 ad.		67,607
097 130 023530	SIVA ÜSTÜ PLS ZAYIF AKIM KUTUSU (TABAN SAÇLI) 35X30 CM	1 ad.		75,337



<b>DUYLAR</b>				
040 109 040002	İTALYAN DUY E 27	50 ad.		1,715
040 109 040001	İTALYAN DUY E 14	100 ad.		1,602
040 109 040005	İTALYAN DUY RONDELASI E27	100 ad.		0,450
040 109 040003	İTALYAN DUY RONDELASI E14	100 ad.		0,394
040 109 030004	MİSFER E 27 BRONZ DUY	50 ad.		4,217
040 109 030003	MİSFER E 14 BRONZ DUY	100 ad.		3,936
024 109 010008	BAKALİT ASMA DUY	50 ad.		1,293
039 109 010009	PLASTİK MİNYONET DUY	100 ad.		0,304
039 109 010010	MİNYON DONANMA DUY	100 ad.		1,518
072 109 010001	DUVAR DUY	50 ad.		1,389
072 109 010002	TAVAN DUY	50 ad.		1,389
024 109 010004	TAVAN GLOP DİBİ	24 ad.		2,101
024 109 010003	DUVAR GLOP DİBİ	24 ad.		2,101
024 109 010005	YAĞMUR DUY	50 ad.		1,335





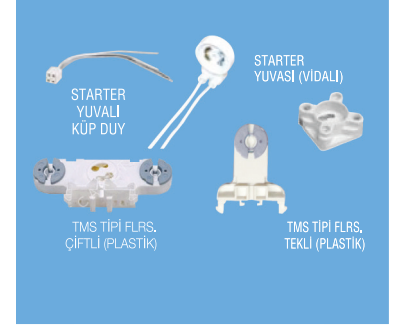

<b>FLORESANT SOKETLER</b>				
004 078 000001	TMS TİPİ FLRS. TEKLİ (PLASTİK)	50 tkm.		1,639
004 078 000002	TMS TİPİ FLRS. SOKETİ ÇİFTLİ (PLASTİK)	25 tkm.		4,329
004 078 000003	TMS STARTER YUVASI (GEÇMELİ)	100 ad.		0,510
001 078 010004 00 00	VIDALI TİP AY AYAK	250 ad.		0,116
004 078 000004	STARTER YUVASI (VIDALI)	100 ad.		1,012
072 078 010003	SİMİT FLORESANT AY AYAK	250 ad.		0,057
076 109 010007	32 WAT SİMİT KÜP DUY	100 ad.		2,205
076 109 010006	STARTER YUVALI KÜP DUY	100 ad.		2,977

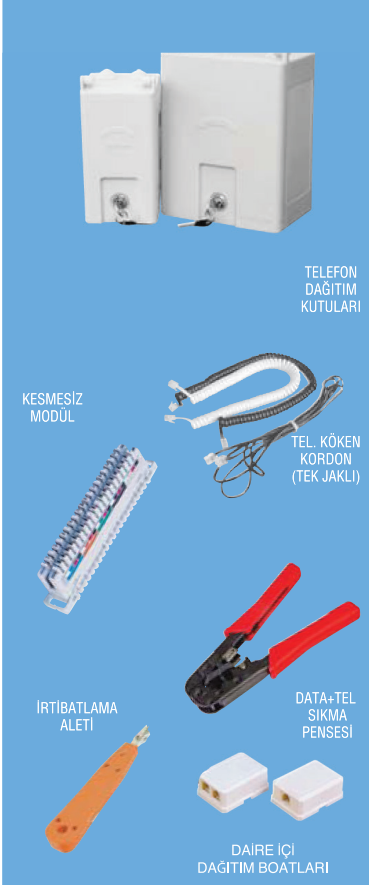

<b>FİŞ ÇEŞİTLERİ</b>				
023 109 000001	PRİZMATİK ÇOCUK KORUMA KAPAĞI	100 ad.		2,000
999 999 000186	2 MT. KABLOLU BASKILI TEYP FİŞİ	1 ad.		4,217
024 109 060001	DUY FİŞ PERÇİNLİ	50 ad.		1,476
024 109 060002	DUY PRİZ	50 ad.		3,205
031 114 020005	TV ERKEK FİŞİ	100 ad.		0,560
031 114 020006	TV DIŞI FİŞİ	100 ad.		0,560
031 114 000050	OK-050 F KONNEKTÖR RG-6	100 ad.		0,504
031 114 000051	OK-051 F KONNEKTÖR RG-59	100 ad.		0,524
031 114 000057	OK-057 F ARA KONNEKTÖR	100 ad.		0,735
031 114 000062	OK-062İ 3RCA-3RCA ARA KABLO	1 ad.		2,310 USD.
031 114 000065	OK-065İ SCART-3RCA ARA KABLO (IN)	1 ad.		1,843 USD.
031 114 000063	OK-063İ SCART-SCART ARA KABLO	1 ad.		1,995 USD.
031 114 000088	OK-88İ JAKLI TELEFON FİŞİ	50 ad.		0,924 USD.
031 114 000082	OK-082İ 6P4C DIŞI ARA ADAPTÖR	1 ad.		0,537 USD.





Ürün Kodu	Açıklama / Stok Cinsi	Ambalaj (Kutu/Bağ)	Ambalaj (Koli/Çuval)	TL
<b>TELEFON DAĞITIM KUTULARI ve AKSESUARLARI</b>				
001 049 001020 00 17	TLF. DĞT. KUTUSU (10 - 20) BOŞ PLS. KLT	2 ad.	60	13,564
001 049 201020 00 17	TLF.DĞT.KUTUSU(10-20)BOŞ PLS.KLT(A. YAYMAYAN)  IP40	2 ad.	60	18,311
001 049 011020 00 17	TLF. DĞT. KUTUSU (10 - 20) BOŞ KİLİTLİ	2 ad.	60	21,150
001 049 211020 00 17	TLF.DĞT.KUTUSU(10-20)BOŞ(KİLİTLİ) (A. YAYMAYAN)  IP40	2 ad.	60	28,552
001 049 001050 00 17	TLF. DĞT. KUTUSU(10-50) BOŞ PLS.KİLİT	1 ad.	28	20,524
001 049 201050 00 17	TLF.DĞT.KUTUSU(10-50)BOŞ PLS.KLT(A. YAYMAYAN)  IP40	1 ad.	28	27,708
001 049 011050 00 17	TLF. DĞT. KUTUSU(10-50) KİLİTLİ	1 ad.	28	27,464
001 049 211050 00 17	TLF.DĞT.KUTUSU(10-50)(KİLİTLİ) (A. YAYMAYAN)  IP40	1 ad.	28	37,077
061 049 015012	H.TDK. (50 - 120) KİLİTLİ TİP. PER. BOŞ.	1 ad.	12	66,990
001 024 000001 00 00	ÇATI (1 MODÜL İÇİN)	1 ad.	1000	1,019
001 024 000002 00 00	ÇATI (2 MODÜL İÇİN)	1 ad.	500	2,036
001 024 000003 00 00	ÇATI (3 MODÜL İÇİN)	1 ad.	400	3,194
001 024 000004 00 00	ÇATI (4 MODÜL İÇİN)	1 ad.	300	4,257
001 024 000005 00 00	ÇATI (5 MODÜL İÇİN)	1 ad.	200	5,322
001 024 000010 00 00	ÇATI (10 MODÜL İÇİN)	1 ad.	100	10,182
888 049 050001	KESMESİZ MODÜL	10 ad.	250	1,958 USD.
888 049 050002	KESMELİ MODÜL	10 ad.	250	2,156 USD.
888 049 050003	İRTİBATLAMA ALETİ	1 ad.	50	11,244 USD.
031 049 040001	DAİRE İÇİ TLF.DĞT. KUTUSU (TEK JAKLI)	10 ad.	50	0,562 USD.
031 049 040002	DAİRE İÇİ TLF.DĞT. KUTUSU (ÇİFT JAKLI)	10 ad.	50	0,647 USD.
888 049 050005	TELEFON SİRİRAL KORDONU	1 ad.	100	0,770 USD.
888 049 050006	TELEFON KÖKEN KORDON (TEK JAKLI)	1 ad.	100	0,638 USD.
888 049 050007	TELEFON KÖKEN KORDON (ÇİFT JAKLI)	1 ad.	100	0,715 USD.
888 101 010012	DATA+TEL. SIKMA PENSESİ 8P6P	1 ad.	5	22,489 USD.
888 049 050011	VT4001 4P4C PLUG	100 ad.	1000	0,036 USD.
888 049 050010	VT4003 8P8C PLUG	100 ad.	1000	0,076 USD.
888 049 050016	VT4006 4P4C SİRİRAL KORUYUCU (FIRDÖNDÜ)	1 ad.	100	1,433 USD.

<b>KONTROL KALEMLERİ (İTHAL)</b>				
888 119 010008	FHT-808A VOL.TEST K.KALEMİ AC/DC 100-250V	10 ad.		0,775 USD.
888 119 010003	FHT-159 VOL.TEST K.KALEMİ AC/DC 100-250V	12 ad.		0,887 USD.
888 119 010007	FHT-608 VOL.TEST K.KALEMİ AC/DC 100-250V	12 ad.		1,785 USD.
888 119 010006	FHT-304C VOL.TEST K.KALEMİ AC/DC 100-250V	12 ad.		0,704 USD.
888 119 010010	FHT-2006 VOL.TEST K.KAL.AC 110/220/380V	10 ad.		3,572 USD.
888 119 010011	FHT-9818 VOLTAJ TEST KONTROL KALEMİ	25 ad.		2,399 USD.
888 119 010012	FHT-9848 MULTI-FUNCTION ELECTRICAL TEST.	20 ad.		6,920 USD.
888 119 010002	FHT-030 9'LU TEST TAKIM KUTUSU	1 ad.		3,770 USD.
888 119 010001	FHT-023 KONTROL KALEMİ TAKIM KUTUSU	1 ad.		1,835 USD.
888 119 010004	FHT-232 VOL.TEST K.KALEMİ AC/DC 100-250V	20 ad.		1,335 USD.
888 119 010005	FHT-233 VOL.TEST K.KALEMİ AC/DC 100-250V	20 ad.		1,301 USD.
888 119 010009	FHT-828R DİJ.VOLT.TEST.12,36,55,110,220V	50 ad.		1,735 USD.
888 119 010013	FHT-601 İNCE TİP KONT.KALEMİ DÜZ AC/DC 100-500V	1 ad.		0,934 USD.
888 119 010014	FHT-611 İNCE TİP KONT. KALEMİ YILDIZ AC/DC 100-500V	1 ad.		0,934 USD.
888 119 010015	FHT-602 KALIN TİP KONT. KALEMİ DÜZ AC/DC 100-500V	1 ad.		1,001 USD.
888 119 010016	FHT-612 KALIN TİP KONT. KALEMİ YILDIZ AC/DC 100-500V	1 ad.		1,001 USD.
888 119 010018	FHT-958 KOPIK HAT DEDEKTÖRÜ	1 ad.		6,563 USD.

<b>KONTROL KALEMLERİ</b>				
104 119 000001	JUMBO DÜZ KONTROL KALEMİ	12 ad.	360	1,441
104 119 000002	JUMBO YILDIZ KONTROL KALEMİ	12 ad.	360	1,668
104 119 000003	COMBO DÜZ KONTROL KALEMİ	12 ad.	360	1,668
104 119 000004	COMBO YILDIZ KONTROL KALEMİ	12 ad.	360	1,820
104 119 500001	LÜX DÜZ KONTROL KALEMİ	12 ad.	360	6,044
104 119 500002	LÜX YILDIZ KONTROL KALEMİ	12 ad.	360	6,325

Ürün Kodu	Açıklama / Stok Cinsi	Ambalaj (Kutu/Bağ)	Ambalaj (Koli/Çuval)	TL
<b>VIP-TEC KOMBİNE PENSE</b>				
105 101 210160	VT210160 VIP-TEC KOMBİNE PENSE 160MM	6 ad.		48,969
105 101 210180	VT210180 VIP-TEC KOMBİNE PENSE 180MM	6 ad.		56,362
105 101 210200	VT210200 VIP-TEC KOMBİNE PENSE 200MM	6 ad.		65,807
105 101 215160	VT215160 VIP-TEC YAN KESKİ 160MM	6 ad.		48,969
105 101 215180	VT215180 VIP-TEC YAN KESKİ 180MM	6 ad.		57,149
105 101 200160	VT200160 VIP-TEC PLATINIUM KOMBİNE PENSE 160MM	6 ad.		58,302
105 101 200180	VT200180 VIP-TEC PLATINIUM KOMBİNE PENSE 180MM	6 ad.		62,856
105 101 201160	VT201160 VIP-TEC PLATINIUM YAN KESKİ 160MM	6 ad.		58,246
105 101 201180	VT201180 VIP-TEC PLATINIUM YAN KESKİ 180MM	6 ad.		62,940
105 119 210309	VT210309 VIP-TEC MULTIBAG TORN.-PENSE TAKIMI (9 PRÇ)	1 ad.		227,276
105 119 200309	VT200309 VIP-TEC MULTIBAG TORN.-PENSE TAKIMI (9 PRÇ)	1 ad.		273,659

### VIP-TEC TORNAVİDALAR

105 101 610031	VT6100/31 VIP-TEC DÜZ UÇLU TORNAVİDA 3.0X75MM	12 ad.		5,425
105 101 610042	VT6100/42 VIP-TEC DÜZ UÇLU TORNAVİDA 4.0X100MM	12 ad.		9,164
105 101 610052	VT6100/52 VIP-TEC DÜZ UÇLU TORNAVİDA 5.5X100MM	12 ad.		10,626
105 101 610063	VT6100/63 VIP-TEC DÜZ UÇLU TORNAVİDA 6.5X125MM	12 ad.		13,465
105 101 620031	VT6200/31 VIP-TEC YILDIZ UÇLU TORNAVİDA PH0X75MM	12 ad.		5,959
105 101 620042	VT6200/42 VIP-TEC YILDIZ UÇLU TORNAVİDA PH1X100MM	12 ad.		9,164
105 101 620062	VT6200/62 VIP-TEC YILDIZ UÇLU TORNAVİDA PH2X100MM	12 ad.		11,750
105 101 620063	VT6200/63 VIP-TEC YILDIZ UÇLU TORNAVİDA PH2X125MM	12 ad.		13,156
105 101 607000	VT6000/7ST1 VIP-TEC ART TORNAVİDA SETİ (7 PRÇ)	1 ad.		71,261
105 119 006190	VT6190 VIP-TEC DÜZ UÇLU KONTROL KALEMİ 3.5MM	24 ad.		9,642
105 119 006191	VT6191 VIP-TEC YILDIZ UÇLU KONTROL KALEMİ PH0	24 ad.		9,642
105 119 006192	VT6192 VIP-TEC CEP KONTROL KALEMİ 4.0MM	24 ad.		9,024
105 119 006193	VT6193 VIP-TEC DÜZ UÇLU KONTROL KALEMİ 3.5MM	24 ad.		10,007

### VIP-TEC 1000V İZOLELİ ALETLER

105 101 201309	VT201309 VIP-TEC 1000V İZOLELİ PENSE-TORN. ÇANTA (9 PRÇ)	1 ad.		326,226
105 101 201310	VT201310 VIP-TEC 1000V İZOLELİ PENSE-TORN. ÇANTA (10 PRÇ)	1 ad.		491,883
105 101 210318	VT210318 VIP-TEC MULTIBAG JUMBO TAKIM (18 PRÇ)	1 ad.		547,318
105 101 810032	VT8100/32 VIP-TEC 1000V İZOLELİ DÜZ UÇLU TORN. 3.0X100MM	12 ad.		11,160
105 101 810042	VT8100/42 VIP-TEC 1000V İZOLELİ DÜZ UÇLU TORN. 4.0X100MM	12 ad.		14,955
105 101 810053	VT8100/53 VIP-TEC 1000V İZOLELİ DÜZ UÇLU TORN. 5.5X125MM	12 ad.		17,316
105 101 810064	VT8100/64 VIP-TEC 1000V İZOLELİ DÜZ UÇLU TORN. 6.5X125MM	12 ad.		20,999
105 101 820030	VT8200/30 VIP-TEC 1000V İZOLELİ YILDIZ UÇLU TORN. PH0X60MM	12 ad.		10,401
105 101 820041	VT8200/41 VIP-TEC 1000V İZOLELİ YILDIZ UÇLU TORN. PH1X80MM	12 ad.		13,915
105 101 820062	VT8200/62 VIP-TEC 1000V İZOLELİ YILDIZ UÇLU TORN. PH2X100MM	12 ad.		18,075
105 101 820084	VT8200/84 VIP-TEC 1000V İZOLELİ YILDIZ UÇLU TORN. PH3X150MM	12 ad.		27,549
105 101 205160	VT205160 VIP-TEC 1000V İZOLELİ KOMBİNE PENSE 160MM	6 ad.		64,992
105 101 205180	VT205180 VIP-TEC 1000V İZOLELİ KOMBİNE PENSE 180MM	6 ad.		68,843
105 101 206160	VT206160 VIP-TEC 1000V İZOLELİ YAN KESKİ 160MM	6 ad.		64,992
105 101 206180	VT206180 VIP-TEC 1000V İZOLELİ YAN KESKİ 180MM	6 ad.		67,410
105 101 208160	VT208160 VIP-TEC 1000V İZOLELİ EĞRİ KARGABURNU 160MM	6 ad.		59,707

### VIP-TEC METAL TAKIM ÇANTASI

105 101 105051	VT895105D-51 ELEKTRİKÇİ TİP METAL TAKIM ÇANTASI (51 PRÇ)	1 ad.		1.108,551
----------------	--	-------	--	-----------

### JOKARİ KABLO SİYIRMA VE KESME İÇİN EL ALETLERİ

129 087 000351	10160 4-16MM TÜM YUVARLAK KABLO KILIFLARINI SOYMAK İÇİN	1 ad.		18,237 EUR.
129 087 000352	10270 8-28MM TÜM YUVARLAK KABLO KILIFLARINI SOYMAK İÇİN	1 ad.		18,237 EUR.
129 087 000353	10272 8-28MM TÜM YUVARLAK KABLO KILIFLARINI SOYMAK İÇİN	1 ad.		18,237 EUR.
129 087 000354	10280 8-28MM TÜM YUVARLAK KABLO KILIFLARINI SOYMAK İÇİN	1 ad.		18,237 EUR.
129 087 000355	10282 8-28MM TÜM YUVARLAK KABLO KILIFLARINI SOYMAK İÇİN	1 ad.		18,237 EUR.
129 087 000356	10350 27-35MM TÜM YUVARLAK KABLO KILIFLARINI SOYMAK İÇİN	1 ad.		28,480 EUR.
129 087 000357	20030 GENİŞLİK MAX.12MM YE VARAN VE 0,75-2,5MM ARASI PVC İZALASYON YASSI KABLolar İÇİN	1 ad.		77,696 EUR.
129 087 000358	20040 0,5-4MM TÜM YUVARLAK KABLO KILIFLARINI SOYMAK İÇİN	1 ad.		25,919 EUR.
129 087 000359	20050 MAX.2,5MMYE KADAR OLAN İLETKENLER İÇİN, UZUNLUK STOPU 6-15MM ARASI AYARLANABİLİR	1 ad.		25,919 EUR.
129 087 000360	20060 MAX.2,5MMYE KADAR OLAN İLETKENLER İÇİN, UZUNLUK STOPU 6-18MM ARASI AYARLANABİLİR	1 ad.		62,457 EUR.
129 087 000361	20070 PUR VE TPE DİŞ İZALASYONLU AS ARABİRİM KABLolar İÇİN	1 ad.		148,646 EUR.
129 087 000362	20090 ÇAPLARI 6-16MM ARASI OLAN İLETKENLER İÇİN	1 ad.		78,070 EUR.
129 087 000363	20100 0,2-6MM ARASI SERT VE ESNEK TEK DAMARLI İLETKENLER VE ZİL TELİ İÇİN UZUNLUK STOPU 6-18MM ARASI AYARLANABİLİR	1 ad.		52,082 EUR.
129 087 000364	30100 TÜM COAX KABLolar İÇİN PVC-FLEXIBLE 3X0,75MM	1 ad.		25,982 EUR.
129 087 000365	30120 ÇAPLARI 8-13MM ARASI OLAN TÜM YUVARLAK KABLolarIN DİŞ KILIFINI SOYMAK İÇİN	1 ad.		25,928 EUR.
129 087 000366	30150 ÇAPLARI 8-13MM ARASI OLAN TÜM YUVARLAK KABLolarIN DİŞ KILIFINI SOYMAK İÇİN	1 ad.		33,727 EUR.
129 087 000367	30160 DATA TRANSFERİ VE DENETİM HATLARI İÇİN KULLANILAN PVC İZALASYON KAB.İÇİN ÖZEL.KILIF SOYMA VE İZALASYON SİYIRMAK İÇİN	1 ad.		49,341 EUR.

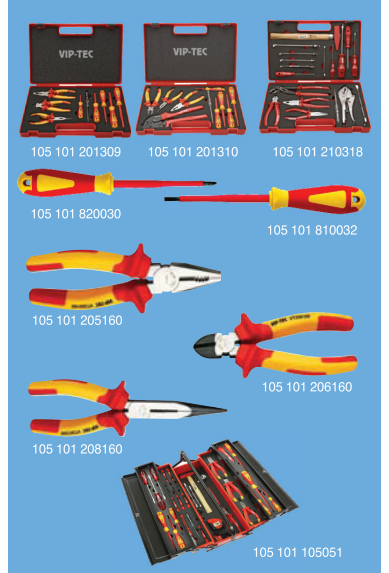



YENİ

Ürün Kodu	Açıklama / Stok Cinsi	Ambalaj (Kutu/Bağ)	Ambalaj (Koli/Çuval)	TL
-----------	-----------------------	--------------------	----------------------	----

**BETON ÇİVİLİ KROŞELER (MUTLUSAN)**

032 048 070000	NO:0 BETON ÇİVİLİ KROŞE(0.75 YASSIKORD.)	MUTLUSAN	1000 ad.	30000	0,021
032 048 070001	NO:1 BETON ÇİVİLİ KROŞE(0.75 YASSIKORD.)	MUTLUSAN	1000 ad.	30000	0,021
032 048 070002	NO:2 BETON ÇİVİLİ KROŞE(0.75 YASSIKORD.)	MUTLUSAN	1000 ad.	20000	0,021
032 048 070003	NO. 3 BETON ÇİVİLİ KROŞE (2X1.5-3X1.5)	MUTLUSAN	1000 ad.	20000	0,028
032 048 070004	NO. 4 BETON ÇİVİLİ KROŞE (2X4)	MUTLUSAN	1000 ad.	20000	0,028
032 048 070005	NO. 5 BETON ÇİVİLİ KROŞE (2X4-4X4)	MUTLUSAN	1000 ad.	10000	0,040
032 048 070006	NO. 6 BETON ÇİVİLİ KROŞE (2X6)	MUTLUSAN	1000 ad.	10000	0,040
032 048 070007	NO. 7 BETON ÇİVİLİ KROŞE (4X10)	MUTLUSAN	1000 ad.	8000	0,083
032 048 070008	NO. 8 BETON ÇİVİLİ KROŞE (3X16+10)	MUTLUSAN	1000 ad.	5000	0,102
032 048 070009	NO. 9 BETON ÇİVİLİ KROŞE (3X25+16)	MUTLUSAN	1000 ad.	5000	0,132

**BETON ÇİVİLİ KROŞELER (NETSAN)**

032 048 090000	NO:0 BETON ÇİVİLİ KROŞE(0.75 YASSIKORD.)	NETSAN	1000 ad.	20000	0,021
032 048 090001	NO:1 BETON ÇİVİLİ KROŞE(0.75 YASSIKORD.)	NETSAN	1000 ad.	20000	0,021
032 048 090002	NO:2 BETON ÇİVİLİ KROŞE(0.75 YASSIKORD.)	NETSAN	1000 ad.	20000	0,021
032 048 090003	NO. 3 BETON ÇİVİLİ KROŞE (2X1.5-3X1.5)	NETSAN	1000 ad.	20000	0,028
032 048 090004	NO. 4 BETON ÇİVİLİ KROŞE (2X4)	NETSAN	1000 ad.	20000	0,028
032 048 090005	NO. 5 BETON ÇİVİLİ KROŞE (2X4-4X4)	NETSAN	1000 ad.	10000	0,040
032 048 090006	NO. 6 BETON ÇİVİLİ KROŞE (2X6)	NETSAN	1000 ad.	10000	0,040
032 048 090007	NO. 7 BETON ÇİVİLİ KROŞE (4X10)	NETSAN	1000 ad.	5000	0,083
032 048 090008	NO. 8 BETON ÇİVİLİ KROŞE (3X16+10)	NETSAN	1000 ad.	5000	0,102

**BETON ÇİVİLİ KROŞELER (GÖÇMEN)**

032 048 080000	NO:0 BETON ÇİVİLİ KROŞE(0.75 YASSIKORD.)	GÖÇMEN	1000 ad.	40000	0,024
032 048 080001	NO:1 BETON ÇİVİLİ KROŞE(0.75 YASSIKORD.)	GÖÇMEN	1000 ad.	40000	0,024
032 048 080002	NO:2 BETON ÇİVİLİ KROŞE(0.75 YASSIKORD.)	GÖÇMEN	1000 ad.	40000	0,024
032 048 080003	NO. 3 BETON ÇİVİLİ KROŞE (2X1.5-3X1.5)	GÖÇMEN	1000 ad.	24000	0,030
032 048 080004	NO. 4 BETON ÇİVİLİ KROŞE (2X4)	GÖÇMEN	1000 ad.	24000	0,030
032 048 080005	NO. 5 BETON ÇİVİLİ KROŞE (2X4-4X4)	GÖÇMEN	1000 ad.	20000	0,042
032 048 080006	NO. 6 BETON ÇİVİLİ KROŞE (2X6)	GÖÇMEN	1000 ad.	18000	0,042
032 048 080007	NO. 7 BETON ÇİVİLİ KROŞE (4X10)	GÖÇMEN	800 ad.	9600	0,091
032 048 080008	NO. 8 BETON ÇİVİLİ KROŞE (3X16+10)	GÖÇMEN	400 ad.	4800	0,112
032 048 080009	NO. 9 BETON ÇİVİLİ KROŞE (3X25+16)	GÖÇMEN	400 ad.	4800	0,135

**GALVANİZLİ SAÇ KROŞELER**

001 048 060001 00 00	NO. 1 TEKLİ GALVANİZ SAÇ KROŞE 12MM		1500 ad.		0,074
001 048 060002 00 00	NO. 2 TEKLİ GALVANİZ SAÇ KROŞE 14MM		1000 ad.		0,083
001 048 060003 00 00	NO. 3 TEKLİ GALVANİZ SAÇ KROŞE 17MM		700 ad.		0,091
001 048 060004 00 00	NO. 4 TEKLİ GALVANİZ SAÇ KROŞE 20MM		500 ad.		0,111
001 048 060007 00 00	NO. 7 TEKLİ GALVANİZ SAÇ KROŞE 26MM		350 ad.		0,142
001 048 060008 00 00	NO. 8 TEKLİ GALVANİZ SAÇ KROŞE 34MM		250 ad.		0,192
001 048 060009 00 00	NO. 9 TEKLİ GALVANİZ SAÇ KROŞE 43MM		200 ad.		0,253
001 048 060010 00 00	NO. 10 TEKLİ GALVANİZ SAÇ KROŞE 53MM		150 ad.		0,289
001 048 060011 00 00	NO. 11 TEKLİ GALVANİZ SAÇ KROŞE 55MM		120 ad.		0,355
001 048 070002 00 00	NO. 2 ÇİFTLİ GALVANİZ SAÇ KROŞE 13MM		600 ad.		0,097
001 048 070003 00 00	NO. 3 ÇİFTLİ GALVANİZ SAÇ KROŞE 16MM		500 ad.		0,115
001 048 070004 00 00	NO. 4 ÇİFTLİ GALVANİZ SAÇ KROŞE 22MM		400 ad.		0,134
001 048 070007 00 00	NO. 7 ÇİFTLİ GALVANİZ SAÇ KROŞE 25MM		400 ad.		0,153
001 048 070008 00 00	NO. 8 ÇİFTLİ GALVANİZ SAÇ KROŞE 35MM		300 ad.		0,243
001 048 070009 00 00	NO. 9 ÇİFTLİ GALVANİZ SAÇ KROŞE 45MM		200 ad.		0,305
001 048 070010 00 00	NO. 10 ÇİFTLİ GALVANİZ SAÇ KROŞE 50MM		150 ad.		0,354
001 048 070011 00 00	NO. 11 ÇİFTLİ GALVANİZ SAÇ KROŞE 55MM		100 ad.		0,415

**P KLİPS ÇEŞİTLERİ**

106 048 000001	P-1 KLİPS 7 mm		100 ad.		0,382
106 048 000002	P-2 KLİPS 10 mm		100 ad.		0,394
106 048 000003	P-3 KLİPS 14 mm		100 ad.		0,405
106 048 000004	P-4 KLİPS 16 mm		100 ad.		0,419
106 048 000005	P-5 KLİPS 21 mm		100 ad.		0,450
106 048 000006	P-6 KLİPS 28 mm		100 ad.		0,475
106 048 000007	P-7 KLİPS 35 mm		100 ad.		0,517
106 048 000008	P-8 KLİPS 42 mm		100 ad.		0,559
106 048 000009	P-9 KLİPS 55 mm		100 ad.		0,627
106 048 000010	P-10 KLİPS 60 mm		100 ad.		0,652

**RAY KROŞE VE TANDIR KROŞELER**

035 048 100001	NO. 1 RAY KROŞE (2X1.5-4X2.5)		350 ad.		0,323
035 048 100002	NO. 2 RAY KROŞE (4X4-4X16)		250 ad.		0,337
001 025 010100 00 00	GALVANİZ KROŞE RAYI (1M)		50 ad.		2,641
035 048 110001	NO. 1 TANDIR KROŞE (2X1.5-2X6)		350 ad.		0,247
035 048 110002	NO. 2 TANDIR KROŞE (4X6)		250 ad.		0,247
035 048 110003	NO. 3 TANDIR KROŞE (4X10)		250 ad.		0,247
035 048 110004	NO. 4 TANDIR KROŞE (4X16)		150 ad.		0,309
035 048 110005	NO. 5 TANDIR KROŞE (3X25+16)		150 ad.		0,309

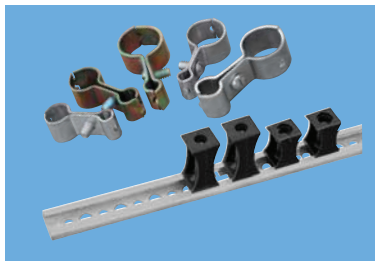
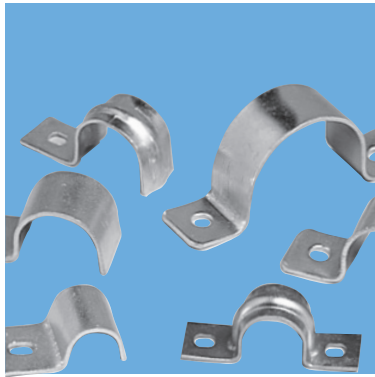

Ürün Kodu	Açıklama / Stok Cinsi	Ambalaj (Kutu/Bağ)	Ambalaj (Koli/Çuval)	TL
<b>PLASTİK DÜBELLER</b>				
016 053 000014	BURGULU ALÇIBAN DÜBELİ (YENİ)	100ad.	10000	0,080
016 053 308100	8X100MM BOŞLUK DÜBELİ	100ad.	10000	0,101
001 053 000001 00 00	ALÇIPAN DÜBEL	100ad.	15000	0,073
016 053 100002	MEGA DÜBEL	1000ad.	14000	0,047
001 053 000002 00 00	KANAL DÜBELİ	1000ad.	14000	0,048
888 129 080185	DÜBELLİ KABLO BAĞI 8X18,5	100ad.	1700	0,197
001 053 000005 00 00	KORNIŞ DÜBELİ	1000ad.	14000	0,057
016 053 000006	6 MM BEYAZ DÜBEL	1000ad.	35000	0,019
016 053 000007	7 MM BEYAZ DÜBEL	1000ad.	25000	0,020
016 053 000008	8 MM BEYAZ DÜBEL	1000ad.	20000	0,021
016 053 000010	10 MM BEYAZ DÜBEL	1000ad.	10000	0,047
016 053 000012	12 MM BEYAZ DÜBEL	250ad.	2500	0,057
016 053 000106	6 MM RENKLİ DÜBEL (YEŞİL)	1000ad.	35000	0,019
016 053 000107	7 MM RENKLİ DÜBEL (SARI)	1000ad.	25000	0,021
016 053 000108	8 MM RENKLİ DÜBEL (KIRMIZI)	1000ad.	10000	0,022
016 053 000110	10 MM RENKLİ DÜBEL (MAVİ)	1000ad.	10000	0,050
016 053 300008	8 MM ROKET DÜBEL	1000ad.	20000	0,066
016 053 300010	10 MM ROKET DÜBEL	500ad.	10000	0,099
<b>DÜBELLİ KROŞELER</b>				
001 048 090002 00 17	3/13 TEKLİ KABLO KROŞESİ	500ad.	10000	0,063
001 048 090006 00 17	8/28 TEKLİ KABLO KROŞESİ	500ad.	5000	0,080
001 048 090001 00 00	ÇİFTLİ KABLO KROŞESİ	100ad.	2500	0,099
001 048 090003 00 17	16'LİK BORU KELEPÇESİ	100ad.	2000	0,100
001 048 090004 00 17	20'LİK BORU KELEPÇESİ	100ad.	1500	0,135
001 048 090005 00 17	25'LİK BORU KELEPÇESİ	100ad.	1000	0,220
<b>ANTİGRON KROŞELER</b>				
128 048 000001	NO:1 ANT. KROŞE(2X1.5-2X2.5-3X1.5-3X2.5)	100ad.	3000	0,167
128 048 000015	NO: 1.5 ANTİGRON KROŞE (2X4-2X6-4X4-4X6)	100ad.	2000	0,176
128 048 000002	NO: 2 ANTİGRON KROŞELER (4X10)	100ad.	1500	0,272
128 048 000003	NO: 3 ANTİGRON KROŞELER (4X16-3X25+16)	50ad.	800	0,408
<b>KANCA VİDALAR</b>				
013 099 031860	18X60 KANCA VİDA (144 ADET)	1grs.		20,015
013 099 031960	19X60 KANCA VİDA (144 ADET)	1grs.		25,862
013 099 031970	19X70 KANCA VİDA (144 ADET)	1grs.		27,211
013 099 032060	20X60 KANCA VİDA (144 ADET)	1grs.		28,673
013 099 032070	20X70 KANCA VİDA (144 ADET)	1grs.		29,797
013 099 032080	20X80 KANCA VİDA (100 ADET)	1grs.		21,364
013 099 032180	21X80 KANCA VİDA (100 ADET)	1grs.		24,175
013 099 021100	21X100 KANCA VİDA (50 ADET)	1grs.		14,055
<b>YILDIZ BAŞLI AĞAÇ VİDALARI</b>				
013 099 011930	19X30 VİDA YILDIZ BAŞLI	12 grs.		6,465
013 099 011935	19X35 VİDA YILDIZ BAŞLI	12 grs.		7,196
013 099 011940	19X40 VİDA YILDIZ BAŞLI	12 grs.		7,871
013 099 012020	20X20 VİDA YILDIZ BAŞLI	12 grs.		6,184
013 099 012025	20X25 VİDA YILDIZ BAŞLI	12 grs.		6,747
013 099 012030	20X30 VİDA YILDIZ BAŞLI	12 grs.		7,871
013 099 012035	20X35 VİDA YILDIZ BAŞLI	12 grs.		8,714
013 099 012040	20X40 VİDA YILDIZ BAŞLI	12 grs.		9,558
013 099 012045	20X45 VİDA YILDIZ BAŞLI	12 grs.		10,626
013 099 012050	20X50 VİDA YILDIZ BAŞLI	12 grs.		11,413
013 099 012060	20X60 VİDA YILDIZ BAŞLI	12 grs.		13,493
<b>SUNTA VİDASI ÇİNKO KAPLAMA</b>				
013 099 043535	3,5X35 SUNTA VİDASI (1000 ADET FİYATI)	1 grs.		44,752
013 099 043540	3,5X40 SUNTA VİDASI (500 ADET FİYATI)	1 grs.		24,456
013 099 040416	4X16 SUNTA VİDASI (1000 ADET FİYATI)	1 grs.		30,135
013 099 040420	4X20 SUNTA VİDASI (1000 ADET FİYATI)	1 grs.		36,881
013 099 040425	4X25 SUNTA VİDASI (500 ADET FİYATI)	1 grs.		22,376
013 099 040430	4X30 SUNTA VİDASI (500 ADET FİYATI)	1 grs.		25,019
013 099 040435	4X35 SUNTA VİDASI (500 ADET FİYATI)	1 grs.		27,886
013 099 040440	4X40 SUNTA VİDASI (500 ADET FİYAT)	1 grs.		31,709
013 099 040445	4X45 SUNTA VİDASI (500ADET FİYAT)	1 grs.		33,621
013 099 040460	4X60 SUNTA VİDASI (200 ADET FİYATI)	1 grs.		16,866
013 099 040450	4X50 SUNTA VİDASI (500 ADET FİYATI)	1 grs.		36,319
013 099 044460	4,5X60 SUNTA VİDASI (200 ADET FİYATI)	1 grs.		20,802
013 099 044530	4,5X30 SUNTA VİDASI (500 ADET FİYATI)	1 grs.		32,159
013 099 044535	4,5X35 SUNTA VİDASI (200 ADET FİYATI)	1 grs.		14,055
013 099 044540	4,5X40 SUNTA VİDASI (200 ADET FİYATI)	1 grs.		15,180
013 099 044545	4,5X45 SUNTA VİDASI (200 ADET FİYATI)	1 grs.		16,417
013 099 044550	4,5X50 SUNTA VİDASI (200 ADET FİYATI)	1 grs.		18,216
013 099 040530	5X30 SUNTA VİDASI (200 ADET FİYATI)	1 grs.		14,505
013 099 040535	5X35 SUNTA VİDASI (200 ADET FİYATI)	1 grs.		17,597
013 099 040540	5X40 SUNTA VİDASI (200 ADET FİYATI)	1 grs.		18,553
013 099 040545	5X45 SUNTA VİDASI (200 ADET FİYATI)	1 grs.		20,802
013 099 040550	5X50 SUNTA VİDASI (200 ADET FİYATI)	1 grs.		23,782
013 099 040560	5X60 SUNTA VİDASI (200 ADET FİYATI)	1 grs.		25,468

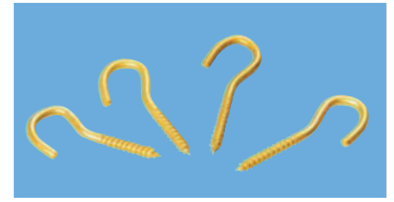
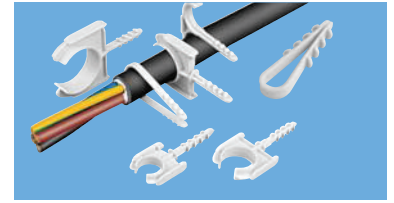



Ürün Kodu	Açıklama / Stok Cinsi	Ambalaj (Kutulu)	Ambalaj Birimi	TL
<b>WAGO BUAT KLEMENSLERİ</b>				
999 094 280225	2X2.5 MM WAGO BUAT KLEMENSİ	1000	ad.	0,538
999 094 280325	3X2.5 MM WAGO BUAT KLEMENSİ	1000	ad.	0,594
999 094 280425	4X2.5 MM WAGO BUAT KLEMENSİ	1000	ad.	0,728
999 094 280525	5X2.5 MM WAGO BUAT KLEMENSİ	1000	ad.	0,800
999 094 280825	8X2.5 MM WAGO BUAT KLEMENSİ	500	ad.	1,770

Ürün Kodu	Açıklama / Stok Cinsi	Ambalaj (Kutulu)	Ambalaj Birimi	TL
<b>WAGO KOMPAKT ÇOK AMAÇLI KLEMENS</b>				
999 094 300412	221-412 İKİLİ ÇOK AMAÇLI KOMPAKT KLEMENS	1000	ad.	1,277
999 094 300413	221-413 ÜÇLÜ ÇOK AMAÇLI KOMPAKT KLEMENS	500	ad.	1,630
999 094 300415	221-415 BEŞLİ ÇOK AMAÇLI KOMPAKT KLEMENS	250	ad.	2,588

- Nominal akım: 32 A
- Nominal gerilim: 450 V
- Yüksek sıcaklıklar için:
  - Sürekli çalışma sıcaklığı: maks. 105 °C
  - Ortam sıcaklığı: maks. 85 °C (T85)

- 0.14-4 mm<sup>2</sup> (24-12 AWG)
- 0.2-4 mm<sup>2</sup> (24-12 AWG)

Tornavida  
Yok  
+ Tüm kablo  
+ Tipleri için  
+ 100%  
Güvenli



## WAGO ÖLÇÜM ALETLERİ



KOD: : 999 094 310810  
ÜRÜN ADI : 206-810 MULTİMETRE  
FİYAT : 190,78 EURO

- AC-DC True-RMS
- Data-Hold Fonksiyonu, diyod test fonksiyonu, buzzer
- 0,01 A -60/600 DC A aralığı seçimi
- 0,01 A -600 AC A aralığı seçimi 40-400Hz arası
- 600mV 600V AC/DC 40-400Hz arası ölçüm seçimi
- Frekans ölçümü Clamp ile 600Hz - 1KHz (>1A)
- Frekans ölçümü Prob ile 600Hz - 10KHz
- 60 Megaohm a kadar direnç, 60mF a kadar kapasite ölçümü
- 4 Dijit LCD Ekran ve otomatik kapanma fonksiyonu
- LED Lamba ile aydınlatma
- CAT III 600 V ve IP44
- TÜV/GS onaylı, IEC/EN 61010-1 (DIN VDE 0411)
- 5 YIL GARANTİ



KOD: : 999 094 310315  
ÜRÜN ADI : 206-315 CLAMP AMPER METRE  
FİYAT : 190,78 EURO

- AC-DC True-RMS Akım ölçümü
- Data-Hold Fonksiyonu
- Max. kabl çapı ø 21 mm
- Dar alanlarda rahat kullanım için küçük boyutlar
- 0,01 A -40 A aralığı seçim yada
- 0,1 A -200 A aralığı seçim
- Saniyede 3 kez deger yenileme
- Otomatik kapanma fonksiyonu
- CAT III 300 V ve IP44
- TÜV/GS onaylı
- IEC/EN 61010-1 (DIN VDE 0411)
- 5 YIL GARANTİ



KOD: : 999 094 310816  
ÜRÜN ADI : 06-316 CLAMP AMPER METRE  
FİYAT : 298,45 EURO

- AC-DC True-RMS Akım/Gerilim ölçümlü multimetre
- Data-Hold Fonksiyonu, diyod test fonksiyonu, buzzer
- 0,01 A -60/600 DC A aralığı seçimi
- 0,01 A -600 AC A aralığı seçimi 40 -400Hz arası
- 600m V-600V AC/DC 40 -400Hz arası ölçüm seçimi
- Frekans ölçümü Clamp ile 600Hz - 1KHz (>1A)
- Frekans ölçümü Prob ile 600Hz - 10KHz
- 60 Megaohm a kadar direnç, 60mF a kadar kapasitör ölçümü
- 4 Dijit LCD Ekran ve otomatik kapanma fonksiyonu
- LED lamba ile aydınlatma
- CAT III 600 V ve IP44
- TÜV/GS onaylı, IEC/EN 61010-1 (DIN VDE 0411)
- 5 YIL GARANTİ



KOD: : 999 094 310806  
ÜRÜN ADI : 206-806 LED GÖSTERGELİ VOLT M.  
FİYAT : 102,00 EURO

- IP65 su ve tozdan koruma
- 6-1000 VAC/DC otomatik gösterim
- AC>100 V gerilimi temassız tespit
- 2 kutup (R-L) faz sırası testi ve faz gösterimi
- 2000 Ω a kadar ölçüm ve Buzzer test
- SCHUKO ve CEE prizler için tek el kullanımı
- LED Lamba özelliği ve otomatik arka plan ışığı
- 35V üzeri hayati gerilimlerde sesli uyarı
- Otomatik kapanma fonksiyonu
- CAT IV 1000 V, IEC/EN 61243-3
- TÜV/GS onaylı
- 5 YIL GARANTİ



KOD: : 999 094 310807  
ÜRÜN ADI : 206-807 PROFİ LCD PLUS  
FİYAT : 168,11 EURO

- LCD ekranlı
- IP65 su ve tozdan koruma
- 6-1000 VAC/DC otomatik gösterim
- AC>100 V gerilimi temassız tespit
- 2 kutup (R-L) faz sırası testi ve faz gösterimi
- 2000 Ω a kadar ölçüm ve Buzzer test
- SCHUKO ve CEE prizler için tek el kullanımı
- LED Lamba özelliği ve otomatik arka plan ışığı
- 35V üzeri hayati gerilimlerde sesli uyarı
- Otomatik kapanma fonksiyonu
- CAT IV 1000 V, IEC/EN 61243-3
- TÜV/GS onaylı
- 5 YIL GARANTİ



KOD: : 999 094 310804  
ÜRÜN ADI : 206-804 TEST BOY  
FİYAT : 49,12 EURO

- Elektrik olan kabloların, prizlerin, arızalı ampullerin tespiti için ideal
- 12-1000 VAC arası tespit
- IP44 ABS Plastik
- CAT III 1000V, IEC/EN 61010-1
- 45 gr ağırlık
- Sesli ve görsel uyarı
- LED fener özelliği
- 2xAAA pil ile çalışır
- 5 YIL GARANTİ

Ürün Kodu	Açıklama / Stok Cinsi	Ambalaj (Kutu/Bağ)	Ambalaj (Koli/Çuval)	TL
<b>GEÇMELİ BUAT KLEMESLERİ</b>				
888 094 260802	BM802 GEÇMELİ BUAT KLEMENSİ ( 2'Li )	400 ad.	6400	0,131 USD.
888 094 260803	BM803 GEÇMELİ BUAT KLEMENSİ ( 3'LÜ )	300 ad.	4800	0,186 USD.
888 094 260804	BM804 GEÇMELİ BUAT KLEMENSİ ( 4'LÜ )	200 ad.	3200	0,226 USD.
888 094 260805	BM805 GEÇMELİ BUAT KLEMENSİ ( 5'Li )	200 ad.	3200	0,262 USD.
015 094 160001	NO. 2 ZEYTİN (BUAT) KLEMENS	1000 ad.	5000	0,089



<b>YENİ GEÇMELİ SOKET KLEMES</b>				
999 999 991212	12'Lİ GEÇMELİ SOKET KLEMENS	30 ad.		13,200



<b>EKO SERİSİ PLASTİK SIRA KLEMENSLER</b>				
015 094 151001	NO. 1 SIRA KLEMENSLER (EKO) (2,5-4 MM2)	50 ad.	1000	1,320
015 094 151002	NO. 2 SIRA KLEMENSLER (EKO) (4-6 MM2)	50 ad.	800	1,595
015 094 151003	NO. 3 SIRA KLEMENSLER (EKO) (6-10 MM2)	50 ad.	600	1,980
015 094 151004	NO. 4 SIRA KLEMENSLER (EKO) (10-16 MM2)	50 ad.	600	2,431
015 094 151005	NO. 5 SIRA KLEMENSLER (EKO) (16-25 MM2)	50 ad.	600	3,630



<b>EKO SERİSİ ISIYA DAYANIKLI SIRA KLEMENSLER</b>				
015 094 171001	NO. 1 ISIYA DAYANIKLI KLEMENSLER (EKO) (2,5-4 MM2)	50 ad.	1000	1,540
015 094 171002	NO. 2 ISIYA DAYANIKLI KLEMENSLER (EKO) (4-6 MM2)	50 ad.	800	1,980
015 094 171003	NO. 3 ISIYA DAYANIKLI KLEMENSLER (EKO) (6-10 MM2)	50 ad.	600	2,420
015 094 171004	NO. 4 ISIYA DAYANIKLI KLEMENSLER (EKO) (10-16 MM2)	50 ad.	600	2,860
015 094 171005	NO. 5 ISIYA DAYANIKLI KLEMENSLER (EKO) (16-25 MM2)	50 ad.	600	4,193

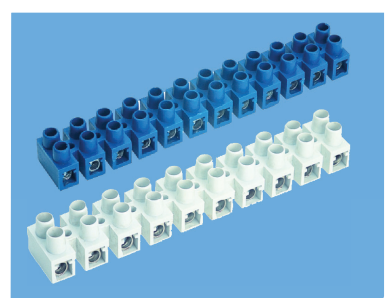

<b>PLASTİK SIRA KLEMENSLER</b>				
015 094 150001	NO. 1 SIRA KLEMENSLER (2,5-4 MM2)	50 ad.	1000	1,705
015 094 150002	NO. 2 SIRA KLEMENSLER (4-6 MM2)	50 ad.	800	2,068
015 094 150003	NO. 3 SIRA KLEMENSLER (6-10 MM2)	50 ad.	600	2,750
015 094 150004	NO. 4 SIRA KLEMENSLER (10-16 MM2)	50 ad.	600	3,080
015 094 150005	NO. 5 SIRA KLEMENSLER (16-25 MM2)	50 ad.	600	5,163

<b>ISIYA DAYANIKLI SIRA KLEMENSLER</b>				
015 094 170001	NO. 1 ISIYA DAYANIKLI KLEMENSLER (2,5-4 MM2)	50 ad.	1000	1,925
015 094 170002	NO. 2 ISIYA DAYANIKLI KLEMENSLER (4-6 MM2)	50 ad.	800	2,475
015 094 170003	NO. 3 ISIYA DAYANIKLI KLEMENSLER (6-10 MM2)	50 ad.	600	2,948
015 094 170004	NO. 4 ISIYA DAYANIKLI KLEMENSLER (10-16 MM2)	50 ad.	600	3,190
015 094 170005	NO. 5 ISIYA DAYANIKLI KLEMENSLER (16-25 MM2)	50 ad.	600	5,380

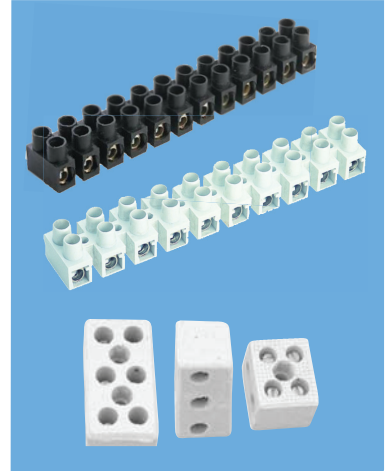

<b>PORSELEN KLEMENSLER</b>				
015 094 180002	NO. 1-2'Lİ PORSELEN KLEMENS	150 ad.		0,836
015 094 180003	NO. 1-3'LÜ PORSELEN KLEMENS	100 ad.		1,089
015 094 180004	NO. 2-2'Lİ PORSELEN KLEMENS	100 ad.		1,089
015 094 180005	NO. 2-3'LÜ PORSELEN KLEMENS	60 ad.		1,430
015 094 180006	NO. 3-2'Lİ PORSELEN KLEMENS	60 ad.		1,430
015 094 180007	NO. 3-3'Lİ PORSELEN KLEMENS	30 ad.		1,940
015 094 180008	NO. 4-2'Lİ PORSELEN KLEMENS	30 ad.		1,940

<b>U KLEMENSLER</b>				
014 094 030006	6'LİK U KLEMENSİ	300 ad.		1,485
014 094 030010	10'LUK U KLEMENSİ	250 ad.		1,814
014 094 030016	16'LİK U KLEMENSİ	100 ad.		2,464
014 094 030025	25'LİK U KLEMENSİ	100 ad.		2,909
014 094 030035	35'LİK U KLEMENSİ	75 ad.		3,251
014 094 030050	50'LİK U KLEMENSİ	50 ad.		4,791
014 094 030070	70'LİK U KLEMENSİ	40 ad.		5,476
014 094 030095	95'LİK U KLEMENSİ	25 ad.		9,240
014 094 030120	120'LİK U KLEMENSİ	20 ad.		11,978
014 094 030150	150'LİK U KLEMENSİ	15 ad.		15,400



<b>ŞEFFAF ISIYA DAYANIKLI BUAT KLEMESLER(EKO SERİSİ)</b>				
888 094 001105	NO.2 ŞEFFAF BUAT KLEMENS (EKO) (1 ADET FİYAT)	560 ad.		0,216
888 094 001205	NO.3 ŞEFFAF BUAT KLEMENS (EKO) (1 ADET FİYAT)	420 ad.		0,356
888 094 001405	NO.4 ŞEFFAF BUAT KLEMENS (EKO) (1 ADET FİYAT)	300 ad.		0,483
888 094 001605	NO.5 ŞEFFAF BUAT KLEMENS (EKO) (1 ADET FİYAT)	160 ad.		0,610



<b>ŞEFFAF ISIYA DAYANIKLI BUAT KLEMESLER</b>				
888 094 000105	NO:2 ŞEFFAF BUAT KLEMENS (1 ADET FİYAT)	560 ad.		0,365
888 094 000205	NO:3 ŞEFFAF BUAT KLEMENS (1 ADET FİYAT)	420 ad.		0,450
888 094 000405	NO:4 ŞEFFAF BUAT KLEMENS (1 ADET FİYAT)	300 ad.		0,759
888 094 000605	NO:5 ŞEFFAF BUAT KLEMENS (1 ADET FİYAT)	160 ad.		1,012

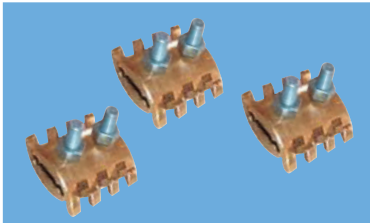
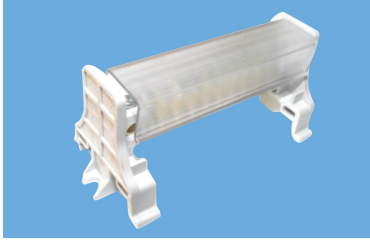

Ürün Kodu	Açıklama / Stok Cinsi	Ambalaj (Kutu/Bağ)	Ambalaj (Koli/Çuval)	TL
<b>125 A. 1 KUTUPLU DAĞITIM ÜNİTESİ (7X12 MM)</b>				
014 102 112507	7 DELİKLİ	1 ad.	65	6,054
014 102 112510	10 DELİKLİ	1 ad.	48	7,265
014 102 112512	12 DELİKLİ	1 ad.	40	8,649
014 102 112515	15 DELİKLİ	1 ad.	36	10,033
014 102 112520	20 DELİKLİ	1 ad.	30	13,836

<b>125 A. 2 KUTUPLU DAĞITIM ÜNİTESİ (7X12 MM)</b>				
014 102 212507	7 DELİKLİ	1 ad.	22	12,740
014 102 212510	10 DELİKLİ	1 ad.	15	14,559
014 102 212512	12 DELİKLİ	1 ad.	14	16,377
014 102 212515	15 DELİKLİ	1 ad.	12	21,505
014 102 212520	20 DELİKLİ	1 ad.	6	27,296

<b>125 A. 4 KUTUPLU DAĞITIM ÜNİTESİ (7X12 MM)</b>				
014 102 412507	7 DELİKLİ	1 ad.	10	27,296
014 102 412510	10 DELİKLİ	1 ad.	8	28,954
014 102 412512	12 DELİKLİ	1 ad.	6	33,086
014 102 412515	15 DELİKLİ	1 ad.	5	39,704
014 102 412520	20 DELİKLİ	1 ad.	4	52,938
014 102 412522	22 DELİKLİ	1 ad.	4	56,222
014 102 412525	25 DELİKLİ	1 ad.	4	66,173

<b>MOTOR KLEMENSLER</b>				
022 094 200001	NO. 1 MOTOR KLEMENS M4	150 ad.		2,339
022 094 200002	NO. 2 MOTOR KLEMENS M4	100 ad.		2,723
022 094 200003	NO. 3 MOTOR KLEMENS M5	100 ad.		3,525
022 094 200004	NO. 4 MOTOR KLEMENS M6	50 ad.		5,129
022 094 200005	NO. 5 MOTOR KLEMENS M8	30 ad.		9,539
022 094 200006	NO 6 MOTOR KLEMENS M10	16 ad.		16,873

<b>TIRNAKLI KLEMENSLER</b>				
014 094 100001	NO:1 TIRNAKLI KLEMENS	500 ad.		2,200
014 094 100002	NO:2 TIRNAKLI KLEMENS	250 ad.		2,980
014 094 100003	NO:3 TIRNAKLI KLEMENS	100 ad.		4,000
014 094 100004	NO:4 TIRNAKLI KLEMENS	100 ad.		6,000
014 094 100005	NO:5 TIRNAKLI KLEMENS	100 ad.		7,218
014 094 100006	NO 6 7 TIRNAKLI KLEMENS	50 ad.		16,000

<b>LİMİT BASINÇ ŞALTERLERİ VE SEVİYE FLATÖRLERİ</b>				<b>IP40</b>
011 095 000500	LM5 (1-6 BAR) MONOFAZE BASINÇ ŞALTERİ	1 ad.		37,950
011 095 000600	LM6 (2-9 BAR) MONOFAZE BASINÇ ŞALTERİ	1 ad.		40,058
011 095 000601	LM6 (2-9 BAR) MONOFAZE BSN. ŞALTERİ THL.	1 ad.		50,093
011 095 000100	LM1 (1-5 BAR) BASINÇ ŞALTERİ TAHLİYESİZ	1 ad.		49,756
011 095 000101	LM1 (1-5 BAR) BASINÇ ŞALTERİ TAHLİYELİ	1 ad.		57,093
011 095 000200	LM2 (2-8 BAR) BASINÇ ŞALTERİ TAHLİYESİZ	1 ad.		49,756
011 095 000201	LM2 (2-8 BAR) BASINÇ ŞALTERİ TAHLİYELİ	1 ad.		57,093
011 095 000300	LM3 (3-11 BAR) BASINÇ ŞALTERİ TAHLİYESİZ	1 ad.		49,756
011 095 000301	LM3 (3-11 BAR) BASINÇ ŞALTERİ TAHLİYELİ	1 ad.		57,093
011 095 000400	LM4 (4-16 BAR) BASINÇ ŞALTERİ TAHLİYESİZ	1 ad.		49,756
011 095 000401	LM4 (4-16 BAR) BASINÇ ŞALTERİ TAHLİYELİ	1 ad.		57,093
011 096 000591	SU SEVİYE FLATÖRÜ (0,6M TTR KABLOLU)	1 ad.		21,336
011 096 000592	SU SEVİYE FLATÖRÜ (1,6M TTR KABLOLU)	1 ad.		28,111
011 096 000593	SU SEVİYE FLATÖRÜ (3M TTR KABLOLU)	1 ad.		31,878
011 096 000590	SU SEVİYE FLATÖRÜ (5M TTR KABLOLU)	1 ad.		39,805
011 096 000594	SU SEVİYE FLATÖRÜ (10M TTR KABLOLU)	1 ad.		61,900
011 096 000595	ATIK SU SEVİYE FLATÖRÜ (3 MT KAUÇUK KABLOLU)	1 ad.		87,959
011 096 000596	ATIK SU SEVİYE FLATÖRÜ (5 MT KAUÇUK KABLOLU)	1 ad.		98,922
011 096 000597	ATIK SU SEVİYE FLATÖRÜ (10 MT KAUÇUK KABLOLU)	1 ad.		137,125
011 096 000598	ATIK SU SEVİYE FLATÖRÜ (15 MT KAUÇUK KABLOLU)	1 ad.		170,352

<b>ŞALTERLER</b>				
041 118 000201	MONOFAZE ŞALTER	1 ad.	100	12,980
041 118 000200	TRİFAZE ŞALTER	1 ad.	50	20,350

Ürün Kodu	Açıklama / Stok Cinsi	Ambalaj (Kutu/Bağ)	Ambalaj (Koli/Çuval)	TL
<b>KAPI VE MERDİVEN OTOMATIĞI</b>				
027 112 00001	GİZLİ KAPI OTOMATIĞI (DOKUNMATİK)	1ad.	20	43,313
027 112 00002	GİZLİ KAPI OTOMATIĞI (BASMATİK)	1ad.	20	43,313
027 112 00007	ELEK. KİLİTLİ (ANAHTARLI) KAPI OTOMATIĞI	1ad.	12	80,850
027 112 00003	BUTONLU KAPI OTOMATIĞI	1ad.	30	31,763
028 112 00004	KAPI OTOMATIĞI (NORMAL)	1ad.	30	30,319
027 112 00005	MERDİVEN OTOMATIĞI (RAYLI)	1ad.	30	23,100
027 112 00006	MERDİVEN OTOMATIĞI (NORMAL)	1ad.	30	23,100

<b>ZİL BUTONU ÇEŞİTLERİ</b>				
037 106 02001	1'Lİ ALÜMİNYUM ZİL BUTONU 1.KALİTE	1ad.		3,754
037 106 02002	2'Lİ ALÜMİNYUM ZİL BUTONU 1.KALİTE	1ad.		7,508
037 106 02003	3'LÜ ALÜMİNYUM ZİL BUTONU 1.KALİTE	1ad.		11,261
037 106 02004	4'LÜ ALÜMİNYUM ZİL BUTONU 1.KALİTE	1ad.		15,015
037 106 02005	5'Lİ ALÜMİNYUM ZİL BUTONU 1.KALİTE	1ad.		18,769
037 106 02006	6'Lİ ALÜMİNYUM ZİL BUTONU 1.KALİTE	1ad.		22,523
037 106 02007	7'Lİ ALÜMİNYUM ZİL BUTONU 1.KALİTE	1ad.		26,276
037 106 02008	8'Lİ ALÜMİNYUM ZİL BUTONU 1.KALİTE	1ad.		30,030
037 106 02009	9'LU ALÜMİNYUM ZİL BUTONU 1.KALİTE	1ad.		33,784
037 106 02010	10'LU ALÜMİNYUM ZİL BUTONU 1.KALİTE	1ad.		37,538

<b>MUTLUSAN UZAKTAN KUM.ZİL ve KAPI PENCERE ALARMLARI</b>				
888 038 218000	Q218 KABLOSUZ KAPI ZİLİ LEDLİ 100 MT. 32MELODİ	1ad.	10	17,325 USD.
888 038 007000	007-D KAPI/PENCERE ALARMI 2 SESLİ	1ad.	10	5,579 USD.
888 038 008000	008-C LEDLİ İNFAR.PIR.SEN.ALARM/KAPI ZİL 32M.8MT	1ad.	10	18,827 USD.

<b>ZİLLER VE ZİL TRAFOLARI</b>				
027 105 010012	ZİL TRAFOSU 12 V	1 ad.	80	10,682
027 105 010015	ZİL TRAFOSU 15 V	1 ad.	30	19,115
018 105 000008	PLA ZİL YASSI BOBINLI 4-8-12 V.	2 ad.	50	35,139
028 105 020003	KAMPANA ZİL 220 V	1 ad.	24	35,139
028 105 020004	KAMPANA ZİL 12V, 24V, 110V	1 ad.	24	42,166
028 105 020000	MUNZAM ZİL ROLESİ	1 ad.	100	22,489
018 105 000006	KANARYA ZİL (TEK SES)	1 ad.	50	6,465
018 105 000007	KANARYA ZİL (ÜÇ SES)	1 ad.	50	7,028
018 105 000001	TELEFON ZİLİ (AYARLI)	1 ad.	50	9,277
018 105 000002	DİNG DONG ZİL ELEKTRONİK (3 SES)	1 ad.	50	9,558
018 105 000003	MEKANİK DİNG DONG ZİL	1 ad.	20	29,516
018 105 000004	KONUŞAN ZİL 120 MELODİ	1 ad.	30	15,461

<b>DİYAFON MERKEZİ VE ŞUBELERİ</b>				
018 104 000001	DİYAFON MERKEZİ 1"Lİ	1ad.		70,277
018 104 000002	DİYAFON MERKEZİ 2"Lİ	1ad.		70,277
018 104 000003	DİYAFON MERKEZİ 3"LÜ	1ad.		70,277
018 104 000004	DİYAFON MERKEZİ 4"LÜ	1ad.		70,277
018 104 000005	DİYAFON MERKEZİ 5'Lİ	1ad.		70,277
018 104 000099	DİYAFON ŞUBESİ	1ad.		7,590

<b>İTHAL ÜRÜNLERİMİZ</b>				
999 999 000081	9V PİLLİ DUMAN DEDEKTÖRÜ	1ad.		14,000 USD.
999 999 000080	KABLOLU GAZ DEDEKTÖRÜ	1ad.		41,250
888 038 250027	360 DERECE PIR HAREKET SENSÖRÜ	1ad.		13,561 USD.
999 133 011019	ERİYEN BANT	1ad.		2,310 USD.
065 133 001019	10X19 İZOLE BANT	1ad.		0,566 USD.
065 133 020000	ÇİFT TARAFLI BANT 1mm 20mm*50mt	50ad.		17,694
065 133 020003	ÇİFT TARAFLI BANT 1mm 25mm*50mt	50mt.		22,117
065 133 020001	ÇİFT TARAFLI BANT 1mm 30mm*50mt	50mt.		26,541



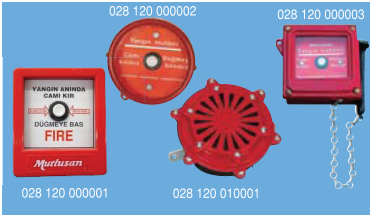

Ürün Kodu	Açıklama / Stok Cinsi	Ambalaj (Kutulu)	Ambalaj Birimi	TL
-----------	-----------------------	------------------	----------------	----

### DÖNER LAMBA FLAŞÖR SİREN REFKONTAK

001 111 020004 00 00	DÖNER LAMBA 220 V AC	1	ad.	52,708
001 111 020001 00 00	DÖNER LAMBA 12 V AC	1	ad.	52,708
001 111 020002 00 00	DÖNER LAMBA 24 V AC	1	ad.	52,708
001 111 030003 00 00	FLAŞÖRLÜ İKAZ LAMBASI 220 V	1	ad.	40,761
026 111 020005	12 V.DC.MIKNATISLI DÖNER LAMBA(OTO TİPİ)	1	ad.	112,443
102 111 000012	LEDLİ FLAŞÖRLÜ ELEKTRONİK SİREN 12V (75 db.)	1	ad.	35,139
102 111 000024	LEDLİ FLAŞÖRLÜ ELEKTRONİK SİREN 24V(75db.)	1	ad.	35,139
102 111 000220	LEDLİ FLAŞÖRLÜ ELEKTRONİK SİREN 220V (75db.)	1	ad.	39,355
026 111 000001	UÇAK İKAZ LAMBASI (AMPULLÜ)	1	ad.	132,121
026 111 000002	UÇAK İKAZ LAMBA SEHPASI	1	ad.	104,363
888 111 050004	MS190 MİNİ SİREN (105 db.)	1	ad.	18,040 USD.
001 999 050005 00 00	MS290P PLASTİK SİREN 220V (80 db.)	1	ad.	35,203
026 111 010001	AS. 1 MOTORLU SİREN (PLS.GÖV.)220V,150W (110 db.)	1	ad.	80,116
026 111 010002	AS. 2 MOTORLU SİREN (PLS.GÖV.)220V,200W (115 db.)	1	ad.	119,471
026 111 010003	AS. 1 MOTORLU SİREN (METAL.GÖV.)220V,150W (112 db.)	1	ad.	130,715
026 111 010004	AS. 2 MOTORLU SİREN (METAL.GÖV.)220V,200W (117 db.)	1	ad.	163,043
026 111 010005	AS.3 MOTORLU SİREN 220V-280W (150 db.)	1	ad.	773,048
026 111 010008	AS.4 MOTORLU SİREN 220V-500W (160 db.)	1	ad.	1.082,267
026 111 010009	AS.5 MOTORLU SİREN 220V-750W (180 db.)	1	ad.	4.638,287

### ALARM KORNA VE YANGIN İHBAR BUTONU

028 120 000001	YANGIN İHBAR BUTONU (KARE)	2	ad.	14,962
028 120 000002	YANGIN İHBAR BUTONU (YUVARLAK)	2	ad.	7,260
028 120 000003	YANGIN İHBAR BUTONU DÖKÜM ÇEKİÇLİ	2	ad.	98,999
028 120 010001	ALARM KORNA (PLASTİK) 220V	1	ad.	21,450
028 120 010002	ALARM KORNA (DÖKÜM) 220V	1	ad.	24,750
028 120 010003	ALARM KORNA (PLASTİK) 12V, 24V, 110V	1	ad.	33,000





## YANGIN ALGILAMA SİSTEMLERİ



Ürün Kodu	Açıklama / Stok Cinsi	Ambalaj (Kutulu)	Ambalaj Birimi	Fiyat
-----------	-----------------------	------------------	----------------	-------

### YANGIN İHBAR KONTROL PANELLERİ-STANDART

006 086 601004	EFİRE ECP-1004 4 ZONLU KONTROL PANELİ	1	ad.	220,000 USD.
006 086 601008	EFİRE ECP-1008 8 ZONLU KONTROL PANELİ	1	ad.	240,000 USD.
006 086 601012	EFİRE ECP-1012 12 ZONLU KONTROL PANELİ	1	ad.	270,000 USD.
006 086 601016	EFİRE ECP-1016 16 ZONLU KONTROL PANELİ	1	ad.	320,000 USD.

### YANGIN İHBAR KONTROL TEKRARLAMA PANELLERİ

006 086 001005	EFİRE ECP-RP-4 4 ZONLU TEKRARLAMA PANELİ	1	ad.	180,000 USD.
006 086 001007	EFİRE ECP-RP-8 8 ZONLU TEKRARLAMA PANELİ	1	ad.	195,000 USD.
006 086 001012	EFİRE ECP-RP-12 12 ZONLU TEKRARLAMA PANELİ	1	ad.	210,000 USD.
006 086 001017	EFİRE ECP-RP-16 16 ZONLU TEKRARLAMA PANELİ	1	ad.	300,000 USD.
006 086 200015	E-NW-485 TEKRARLAMA PANEL NETWORK KARTI	1	ad.	75,000 USD.

### KURU VE SIZDIRMAZ TİP BAKIM GEREKTİRMİYEN AKÜLER

006 086 101220	BAT-1220 12V / 2AH. KURU TİP AKÜ	1	ad.	29,000 USD.
006 086 101270	BAT-1270 12V / 7AH. KURU TİP AKÜ	1	ad.	35,000 USD.

### YANGIN İHBAR DEDEKTÖRLERİ

006 086 200001	EFİRE EOD OPTİK DUMAN DEDEKTÖRÜ	1	ad.	19,000 USD.
006 086 200005	EFİRE EHD-58 SABİT SICAKLIK DEDEKTÖRÜ-58 C	1	ad.	14,000 USD.
006 086 200006	EFİRE EHD-82 SABİT SICAKLIK DEDEKTÖRÜ-82 C	1	ad.	14,000 USD.
006 086 200002	EFİRE ERD SICAKLIK ARTIŞ HIZI DEDEKTÖRÜ	1	ad.	14,000 USD.
006 086 326225	EFİRE ECD KOMBİNE (DUMAN+ISI) DEDEKTÖRÜ	1	ad.	26,000 USD.
006 086 200003	EFİRE EDB STANDART DEDEKTÖR SÖKETİ	1	ad.	3,000 USD.

### YANGIN İHBAR BUTON, SİRENLERİ VE AKSESUARLARI

006 086 300001	EYİB YNG.İHB.BUT. VE KASASI	1	ad.	12,000 USD.
006 086 401224	AS-1224 ELEKTRONİK SİREN	1	ad.	13,000 USD.
006 086 500009	AS1224-LED LEDLİ ELEKTRONİK SİREN	1	ad.	25,000 USD.
006 086 200020	EFİRE-ES EFİRE ELEKTRONİK SİREN 24V	1	ad.	40,000 USD.
006 086 200021	EFİRE-EB EFİRE ELEKTRONİK FLAŞÖR 24V	1	ad.	55,000 USD.
006 086 200022	EFİRE-ESB EFİRE ELEKTRONİK FLAŞÖRLÜ SİREN 24V	1	ad.	65,000 USD.
006 086 700009	E-PIL-PARALEL İHBAR LAMBASI	1	ad.	12,000 USD.
999 999 777149	EGD 200-220-LPG GAZ DEDEKTÖRÜ 220V	1	ad.	30,000 USD.
999 999 777164	EGD 200-24-LPG GAZ DEDEKTÖRÜ 12-24V	1	ad.	30,000 USD.
999 999 000581	NFE-MEKANİK DEPREM SENSÖRÜ	1	ad.	590,000 USD.
006 086 400220	AS220-ELEKTRONİK SİREN 220V	1	ad.	15,000 USD.
006 086 500010	ASF220-LED LEDLİ ELEKTRONİK SİREN 220V	1	ad.	29,000 USD.
006 125 100110	EYİB NO/NC-YANGIN İHBAR BUTONU NO/NC ÇIKIŞLI	1	ad.	14,000 USD.

### ADRESLİ YANGIN İHBAR PANELLERİ VE AKSESUARLARI

006 086 510240	SAYA 1 LOOP ADRESLİ PANEL 240 ADRES	1	ad.	950,000 EUR.
006 086 530720	SAYA 3 LOOP ADRESLİ PANEL 720 ADRES	1	ad.	1,650,000 EUR.
006 086 210001	V2100-1 LOOP ADRESLİ PANEL 240 ADRES / VELOX	1	ad.	1.625,000 USD.
006 086 220002	V2200-2 LOOP ADRESLİ PANEL 480 ADRES / VELOX	1	ad.	2.625,000 USD.
006 086 440033	4400-3L-3 LOOP ADRESLİ PANEL-720 ADRES / VELOX	1	ad.	5.658,000 USD.
006 086 004020	4020-TEKRARLAMA PANELİ 4000 SERİ PANELLER İÇİN / VELOX	1	ad.	2.080,000 USD.
006 086 004420	4420-RS 485 PANELLER NETWORK KARTI / VELOX	1	ad.	550,000 USD.
006 086 500001	S-485 SAYA PANELLER İÇİN NETWORK KARTI	1	ad.	400,000 EUR.

### ADRESLİ YANGIN İHBAR DEDEKTÖRLERİ

888 888 000100	LV100-ADRESLİ DUMAN DEDEKTÖRÜ / VELOX	1	ad.	39,130 USD.
888 888 000350	LV350-ADRESLİ ISI DEDEKTÖRÜ / VELOX	1	ad.	39,130 USD.
888 888 000200	LV200-ADRESLİ KOMBİNE DEDEKTÖRÜ / VELOX	1	ad.	44,500 USD.
888 888 040900	40900-ADRESLİ DEDEKTÖR SÖKETİ / VELOX	1	ad.	4,000 USD.

### ADRESLİ YANGIN İHBAR BUTON, SİRENLERİ VE MODÜLLER

888 888 040800	40800-ADRESLİ YANGIN İHBAR BUTONU / VELOX	1	ad.	48,000 USD.
888 888 040300	40300-ADRESLİ SİREN / VELOX	1	ad.	90,870 USD.
888 888 040002	40002-2 Lİ ÇIKIŞ RÖLE MODÜLÜ / VELOX	1	ad.	61,000 USD.
888 888 040010	40010-SİREN KONTROL MODÜLÜ (HARİCEN BESLENİR) / VELOX	1	ad.	74,000 USD.
888 888 040100	40100-TEKLİ GİRİŞ İZLEME MODÜLÜ / VELOX	1	ad.	53,000 USD.
888 888 040102	40102-TEKLİ GİRİŞ (İZLEME) 2'Lİ ÇIKIŞ RÖLE MODÜLÜ / VELOX	1	ad.	88,000 USD.
888 888 040110	40110-TEKLİ GİRİŞ (İZLEME) VE SİREN KONTROL MODÜLÜ / VELOX	1	ad.	85,000 USD.
888 888 040500	40500-KONVANSİYONEL ZON MODÜLÜ / VELOX	1	ad.	173,000 USD.

### ÖZEL AMAÇLI ÜRÜNLER

006 086 700010	DLFB-R-IŞIN TİPİ BEAM DEDEKTÖR 3-100 MT / SD3	1	ad.	800,000 EUR.
006 086 700011	DLFB30-R-IŞIN TİPİ BEAM DEDEKTÖR 30MT / SD3	1	ad.	640,000 EUR.
885 325 000138	NB-138-12VDC-SU BASKIN DEDEKTÖRÜ RÖLE ÇIKIŞI / WIZMART	1	ad.	24,000 USD.
885 325 000606	NB-606-4-SİGARA DUMANI ALGILAMA DEDEKTÖRÜ 24V / WIZMART	1	ad.	55,000 USD.
885 326 002000	FS2000E-DAHİLİ ORTAM ALEV DEDEKTÖRÜ / PULNIX	1	ad.	445,000 USD.
885 326 005000	FS5000E-HARİCİ ORTAM ALEV DEDEKTÖRÜ / PULNIX	1	ad.	860,000 USD.

Ürün Kodu

Açıklama / Stok Cinsi

Fiyat

**MAXLOGIC SERİSİ KONVANSİYONEL YANGIN ALARM SANTRALLERİ**

006 090 022102	ML-22102 KONVANSİYONEL YANGIN ALARM SANTRALI, 2 BÖLGE	475,00 USD.
006 090 022104	ML-22104 KONVANSİYONEL YANGIN ALARM SANTRALI, 4 BÖLGE	500,00 USD.
006 090 022108	ML-22108 KONVANSİYONEL YANGIN ALARM SANTRALI, 8 BÖLGE	600,00 USD.
006 090 022116	ML-22116 KONVANSİYONEL YANGIN ALARM SANTRALI, 16 BÖLGE	700,00 USD.



ML-221XX

**MAXLOGIC KONVANSİYONEL STANDART YANGIN ALGILAMA DEDEKTÖRLERİ**

006 090 002110	ML-2110 OPTİK DUMAN DEDEKTÖRÜ	28,00 USD.
006 090 002120	ML-2120 KOMBİNE SICAKLIK DEDEKTÖRÜ	24,00 USD.
006 090 002130	ML-2130 SABİT SICAKLIK DEDEKTÖRÜ	24,00 USD.
006 090 002140	ML-2140 MULTİSENSÖR DEDEKTÖRÜ	42,00 USD.
006 090 003510	ML-0140 DEDEKTÖR SOKETİ	5,00 USD.



ML-2110



MGR-2100



MGR-2500

**MAVİGARD KONVANSİYONEL RÖLE ÇIKIŞLI YANGIN ALGILAMA DEDEKTÖRLERİ**

006 090 002100	MGR-2100 OPTİK DUMAN DEDEKTÖRÜ, RÖLE ÇIKIŞLI, 12V DC	28,00 USD.
006 090 002500	MGR-2500 MULTİSENSÖR DEDEKTÖR (OPTİK DUMAN+SICAKLIK), RÖLE ÇIKIŞLI, 12V DC	42,00 USD.
006 090 003550	MG-3550 DEDEKTÖR SOKETİ (MGR SERİSİ İÇİN)	5,00 USD.

**MAXLOGIC KONVANSİYONEL IŞIN (BEAM) TİPİ DUMAN DEDEKTÖRLERİ**

006 090 002170	ML-2170 IŞIN (BEAM) TİPİ DUMAN DEDEKTÖRÜ (ALICI-VERİCİ DAHİL)	1.350,00 USD.
006 090 002171	ML-2171 IŞIN (BEAM) TİPİ DUMAN DEDEKTÖRÜ ALICISI	900,00 USD.
006 090 002172	ML-2172 IŞIN (BEAM) TİPİ DUMAN DEDEKTÖRÜ VERİCİSİ	450,00 USD.
006 090 002173	ML-2173 REFLEKTÖRLÜ IŞIN (BEAM) TİPİ DUMAN DEDEK. (ALICI-VERİCİ-REFLEKTÖR DAHİL)	1.300,00 USD.
006 090 002174	ML-2174 REFLEKTÖRLÜ IŞIN (BEAM) TİPİ DUMAN DEDEKTÖRÜ, ALICI-VERİCİ ÜNİTESİ	1.225,00 USD.
006 090 000171	ML-0171 IŞIN (BEAM) TİPİ DUMAN DEDEKTÖRÜ REFLEKTÖRÜ, 1'Lİ	75,00 USD.
006 090 000174	ML-0174 IŞIN (BEAM) TİPİ DUMAN DEDEKTÖRÜ REFLEKTÖRÜ, 4'LÜ	300,00 USD.



ML-2170



ML-2173

ML-0174

**MAXLOGIC ELEKTRONİK SİREN, FLAŞÖRLÜ SİREN VE AKSESUARLAR**

006 090 002410	ELEKTRONİK SİREN, KIRMIZI 24V DC	35,00 USD.
006 090 002420	ELEKTRONİK FLAŞÖR	50,00 USD.
006 090 002430	FLAŞÖRLÜ ELEKTRONİK SİREN, KIRMIZI 24V DC	60,00 USD.
006 090 002710	KONVANSİYONEL SİSTEM YANGIN ALARM BUTONU, RESETLENEBİLİR	20,00 USD.



ML-2410



ML-2710

**MAVİGARD İKİ ALARM SEVİYESİ ÇIKIŞLI, ELEKTROKİMYASAL SENSÖRLÜ KONVANSİYONEL GAZ DEDEKTÖRLERİ**

006 090 002012	GD2R-12EC KARBONMONOKSİT GAZ DEDEK. (CO), 12V DC, 2 ALR. SEV. ÇIKIŞLI, ELEKTROKİMYASAL	150,00 USD.
006 090 002024	GD2R-24EC KARBONMONOKSİT GAZ DEDEK. (CO), 24V DC, 2 ALR. SEV. ÇIKIŞLI, ELEKTROKİMYASAL	150,00 USD.
006 090 002220	GD2R-220EC KARBONMONOKSİT GAZ DEDEK. (CO), 230V AC, 2 ALR. SEV. ÇIKIŞLI, ELEKTROKİMYASAL	150,00 USD.
006 090 000120	ML-0120 SIVA ÜSTÜ BAĞLANTI KUTUSU	12,00 USD.



GD2R-XXXEC



ML-0120

**GD / GDR / TGDR SERİSİ KONVANSİYONEL GAZ DEDEKTÖRLERİ**

006 090 041224	GDR-1224L LPG (BÜTAN+PROPAN) DEDEKTÖRÜ, 12/24V DC, RÖLE ÇIKIŞLI	60,00 USD.
006 090 051224	GDR-1224M METAN (DOĞALGAZ) DEDEKTÖRÜ, 12/24V DC, RÖLE ÇIKIŞLI	60,00 USD.
006 090 040220	GDR-220L LPG (BÜTAN+PROPAN) DEDEKTÖRÜ, 230V AC, RÖLE ÇIKIŞLI	60,00 USD.
006 090 050220	GDR-220M METAN (DOĞALGAZ) DEDEKTÖRÜ, 230V AC, RÖLE ÇIKIŞLI	60,00 USD.
006 090 060220	GD-220L LPG (BÜTAN+PROPAN) DEDEKTÖRÜ, 230V AC	60,00 USD.
006 090 070220	GD-220M METAN (DOĞALGAZ) DEDEKTÖRÜ, 230V AC	60,00 USD.
006 090 080220	GD-220EC KARBONMONOKSİT DEDEKTÖRÜ, 230V AC, ELEKTROKİMYASAL	130,00 USD.
006 090 061224	TGDR-1224M TAVAN TİPİ DOĞALGAZ (METAN) DEDEKTÖRÜ, 12/24V DC, RÖLELİ	60,00 USD.
006 090 000120	ML-0120 SIVA ÜSTÜ BAĞLANTI KUTUSU	12,00 USD.



GD-XXXEC



TGDR-1224M



Ürün Kodu	Açıklama / Stok Cinsi	Fiyat
-----------	-----------------------	-------

### MAXLOGİC SERİSİ AKILLI ADRESLİ YANGIN ALARM SANTRALLERİ, 8 ÇEVİRİME KADAR

006 090 001230	ML-1230 YANGIN ALARM SANTRALI, ÇEVİRİMSİZ	1.250,00 USD.
006 090 001231	ML-1231 YANGIN ALARM SANTRALI, 1 ÇEVİRİM, 127 ADRES	1.750,00 USD.
006 090 001232	ML-1232 YANGIN ALARM SANTRALI, 2 ÇEVİRİM, 254 ADRES	2.500,00 USD.
006 090 001233	ML-1233 YANGIN ALARM SANTRALI, 3 ÇEVİRİM, 381 ADRES	3.250,00 USD.
006 090 001234	ML-1234 YANGIN ALARM SANTRALI, 4 ÇEVİRİM, 508 ADRES	4.000,00 USD.
006 090 001235	ML-1235 YANGIN ALARM SANTRALI, 5 ÇEVİRİM, 635 ADRES	4.750,00 USD.
006 090 001236	ML-1236 YANGIN ALARM SANTRALI, 6 ÇEVİRİM, 762 ADRES	5.500,00 USD.
006 090 001237	ML-1237 YANGIN ALARM SANTRALI, 7 ÇEVİRİM, 889 ADRES	6.250,00 USD.
006 090 001238	ML-1238 YANGIN ALARM SANTRALI, 8 ÇEVİRİM, 1016 ADRES	7.000,00 USD.

### MAXLOGİC SERİSİ AKILLI ADRESLİ YANGIN ALARM SANTRALLERİ, 8 ÇEVİRİME KADAR

006 090 001240	ML-1240 YANGIN ALARM SANTRALI, ÇEVİRİMSİZ, PRİNTER	2.750,00 USD.
006 090 001241	ML-1241 YANGIN ALARM SANTRALI, 1 ÇEVİRİM, 127 ADRES, PRİNTER	3.250,00 USD.
006 090 001242	ML-1242 YANGIN ALARM SANTRALI, 2 ÇEVİRİM, 254 ADRES, PRİNTER	4.000,00 USD.
006 090 001243	ML-1243 YANGIN ALARM SANTRALI, 3 ÇEVİRİM, 381 ADRES, PRİNTER	4.750,00 USD.
006 090 001244	ML-1244 YANGIN ALARM SANTRALI, 4 ÇEVİRİM, 508 ADRES, PRİNTER	5.500,00 USD.
006 090 001245	ML-1245 YANGIN ALARM SANTRALI, 5 ÇEVİRİM, 635 ADRES, PRİNTER	6.250,00 USD.
006 090 001246	ML-1246 YANGIN ALARM SANTRALI, 6 ÇEVİRİM, 762 ADRES, PRİNTER	7.000,00 USD.
006 090 001247	ML-1247 YANGIN ALARM SANTRALI, 7 ÇEVİRİM, 889 ADRES, PRİNTER	7.750,00 USD.
006 090 001248	ML-1248 YANGIN ALARM SANTRALI, 8 ÇEVİRİM, 1016 ADRES, PRİNTER	8.500,00 USD.

### MAXLOGİC SERİSİ AKILLI ADRESLİ YANGIN ALARM SANTRALLERİ, 16 ÇEVİRİME KADAR

006 090 001250	ML-1250 YANGIN ALARM SANTRALI, ÇEVİRİMSİZ	4.000,00 USD.
006 090 001251	ML-1251 YANGIN ALARM SANTRALI, 1 ÇEVİRİM, 127 ADRES	4.500,00 USD.
006 090 001252	ML-1252 YANGIN ALARM SANTRALI, 2 ÇEVİRİM, 254 ADRES	5.250,00 USD.
006 090 001253	ML-1253 YANGIN ALARM SANTRALI, 3 ÇEVİRİM, 381 ADRES	6.000,00 USD.
006 090 001254	ML-1254 YANGIN ALARM SANTRALI, 4 ÇEVİRİM, 508 ADRES	6.750,00 USD.
006 090 001255	ML-1255 YANGIN ALARM SANTRALI, 5 ÇEVİRİM, 635 ADRES	7.500,00 USD.
006 090 001256	ML-1256 YANGIN ALARM SANTRALI, 6 ÇEVİRİM, 762 ADRES	8.250,00 USD.
006 090 001257	ML-1257 YANGIN ALARM SANTRALI, 7 ÇEVİRİM, 889 ADRES	9.000,00 USD.
006 090 001258	ML-1258 YANGIN ALARM SANTRALI, 8 ÇEVİRİM, 1016 ADRES	9.750,00 USD.
006 090 001259	ML-1259 YANGIN ALARM SANTRALI, 9 ÇEVİRİM, 1143 ADRES	10.500,00 USD.
006 090 001260	ML-12510 YANGIN ALARM SANTRALI, 10 ÇEVİRİM, 1270 ADRES	11.250,00 USD.
006 090 001261	ML-12511 YANGIN ALARM SANTRALI, 11 ÇEVİRİM, 1397 ADRES	12.000,00 USD.
006 090 001262	ML-12512 YANGIN ALARM SANTRALI, 12 ÇEVİRİM, 1524 ADRES	12.750,00 USD.
006 090 001263	ML-12513 YANGIN ALARM SANTRALI, 13 ÇEVİRİM, 1651 ADRES	13.500,00 USD.
006 090 001264	ML-12514 YANGIN ALARM SANTRALI, 14 ÇEVİRİM, 1778 ADRES	14.250,00 USD.
006 090 001265	ML-12515 YANGIN ALARM SANTRALI, 15 ÇEVİRİM, 1905 ADRES	15.000,00 USD.
006 090 001266	ML-12516 YANGIN ALARM SANTRALI, 16 ÇEVİRİM, 2032 ADRES	15.750,00 USD.

### MAXLOGİC SERİSİ AKILLI ADRESLİ YANGIN ALARM SANTRALLERİ İÇİN OPSİYONEL ÜRÜNLER

006 090 001201	NETWORK MODÜLÜ	500,00 USD.
006 090 001203	ML-123X VE ML-124X PRİNTER MODÜLÜ	1.600,00 USD.
006 090 001209	ML-125XX PRİNTER MODÜLÜ	1.600,00 USD.
006 090 001210	ML-12XX SERİSİ AKILLI ADRESLİ YANGIN ALARM SANT. S/A MON. KUT.	300,00 USD.

### MAVİGARD AGD SERİSİ AKILLI ADRESLİ GAZ DEDEKTÖRLERİ

006 090 011224	AGD-1224L/VIP LPG (BÜTAN+PROPAN) DEDEKTÖRÜ, 12/24V DC	135,00 USD.
006 090 021224	AGD-1224M/VIP METAN (DOĞALGAZ) DEDEKTÖRÜ, 12/24V DC	135,00 USD.
006 090 031224	AGD-1224EC/VIP KARBONMONOKSİT DEDEKTÖRÜ, 24V DC, ELEKTROKİMYASAL	200,00 USD.
006 090 010220	AGD-220L/VIP LPG (BÜTAN+PROPAN) DEDEKTÖRÜ, 230V AC	160,00 USD.
006 090 020220	AGD-220M/VIP METAN (DOĞALGAZ) DEDEKTÖRÜ, 230V AC	160,00 USD.
006 090 030220	AGD-220EC/VIP KARBONMONOKSİT DEDEKTÖRÜ, 230V AC, ELEKTROKİMYASAL	200,00 USD.
006 090 000120	ML-0120 SIVA ÜSTÜ BAĞLANTI KUTUSU	12,00 USD.

Ürün Kodu Açıklama / Stok Cinsi Fiyat

**MAVİGARD / MAXLOGIC AKILLI ADRESLİ YANGIN ALGILAMA DEDEKTÖRLERİ**

006 090 009100	MG-9100 OPTİK DUMAN DEDEKTÖRÜ	60,00 USD.
006 090 009300	MG-9300 ISI DEDEKTÖRÜ	60,00 USD.
006 090 009400	MG-9400 MULTİSENSÖR DEDEKTÖRÜ (OPTİK DUMAN+ISI)	90,00 USD.
006 090 001110	ML-1110 OPTİK DUMAN DEDEKTÖRÜ	60,00 USD.
006 090 001130	ML-1130 SICAKLIK DEDEKTÖRÜ	60,00 USD.
006 090 001140	ML-1140 MULTİSENSÖR DEDEKTÖRÜ	90,00 USD.
006 090 051110	ML-1110.SCI OPTİK DUMAN DEDEKTÖRÜ, KISA DEVRE İZOLATÖRLÜ	80,00 USD.
006 090 051130	ML-1130.SCI SICAKLIK DEDEKTÖRÜ, KISA DEVRE İZOLATÖRLÜ	80,00 USD.
006 090 051140	ML-1140.SCI MULTİSENSÖR DEDEKTÖRÜ, KISA DEVRE İZOLATÖRLÜ	120,00 USD.
006 090 000140	ML-0140 DEDEKTÖR SOKETİ	5,00 USD.
006 090 003510	MG-3510 DEDEKTÖR SOKETİ	5,00 USD.

**MAXLOGIC AKILLI ADRESLİ İŞIN (BEAM) TİPİ DUMAN DEDEKTÖRLERİ**

006 090 001170	ML-1170 İŞIN (BEAM) TİPİ DUMAN DEDEK. (ALICI-VERİCİ DAHİL)	1.600,00 USD.
006 090 051170	ML-1170.SCI İŞIN (BEAM) TİPİ DUMAN DEDEK. KISA DEVRE İZOLATÖRLÜ (ALICI-VERİCİ DAHİL)	1.650,00 USD.
006 090 001171	ML-1171 İŞIN (BEAM) TİPİ DUMAN DEDEK. ALICISI	1.050,00 USD.
006 090 051171	ML-1171.SCI İŞIN (BEAM) TİPİ DUMAN DEDEK. ALICISI, KISA DEVRE İZOLATÖRLÜ	1.100,00 USD.
006 090 001172	ML-1172 İŞIN (BEAM) TİPİ DUMAN DEDEK. VERİCİSİ	550,00 USD.
006 090 001173	ML-1173 REFLEKTÖRLÜ İŞIN (BEAM) TİPİ DUMAN DEDEK. (ALICI-VERİCİ-REFLEKTÖR DAHİL)	1.550,00 USD.
006 090 051173	ML-1173.SCI REFLEKTÖRLÜ İŞIN (BEAM) TİPİ DUMAN DEDEK. KISA DEVRE İZOLATÖRLÜ (ALICI-VERİCİ-REFL. DAHİL)	1.600,00 USD.
006 090 001174	ML-1174 REFLEKTÖRLÜ İŞIN (BEAM) TİPİ DUMAN DEDEK. ALICI-VERİCİ ÜNİTESİ	1.475,00 USD.
006 090 051174	ML-1174.SCI REFLEKTÖRLÜ İŞIN (BEAM) TİPİ DUMAN DEDEK. ALICI-VERİCİ ÜNİTESİ, KISA DEVRE İZOLATÖRLÜ	1.525,00 USD.
006 090 000171	ML-0171 İŞIN (BEAM) TİPİ DUMAN DEDEKTÖRÜ REFLEK. 1'Lİ	75,00 USD.
006 090 000174	ML-0174 İŞIN (BEAM) TİPİ DUMAN DEDEKTÖRÜ REFLEKTÖRÜ, 4'LÜ	300,00 USD.

**MAXLOGIC AKILLI ADRESLİ GİRİŞ/ÇIKIŞ MODÜLLERİ**

006 090 001361	ML-1361 RÖLE KONTROL MODÜLÜ, 1 ÇIKIŞ	125,00 USD.
006 090 051361	ML-1361.SCI RÖLE KONTROL MODÜLÜ, 1 ÇIKIŞ, KISA DEVRE İZOLATÖRLÜ	150,00 USD.
006 090 001362	ML-1362 KONTAK İZLEME MODÜLÜ, 1 GİRİŞ	125,00 USD.
006 090 051362	ML-1362.SCI KONTAK İZLEME MODÜLÜ, 1 GİRİŞ, KISA DEVRE İZOLATÖRLÜ	150,00 USD.
006 090 001363	ML-1363 3-LÜ I/O MODÜLÜ (2 GİRİŞ / 1 ÇIKIŞ)	250,00 USD.
006 090 051363	ML-1363.SCI 3-LÜ I/O MODÜLÜ (2 GİRİŞ / 1 ÇIKIŞ), KISA DEVRE İZOLATÖRLÜ	275,00 USD.
006 090 001366	ML-1366 4/2 I/O MODÜLÜ (4 GİRİŞ / 2 ÇIKIŞ)	300,00 USD.
006 090 051366	ML-1366.SCI 4/2 I/O MODÜLÜ (4 GİRİŞ / 2 ÇIKIŞ), KISA DEVRE İZOLATÖRLÜ	350,00 USD.
006 090 001371	ML-1371 SİREN KONTROL MODÜLÜ, 1 ÇIKIŞLI	150,00 USD.
006 090 051371	ML-1371.SCI SİREN KONTROL MODÜLÜ, 1 ÇIKIŞLI, KISA DEVRE İZOLATÖRLÜ	175,00 USD.
006 090 001372	ML-1372 BÖLGE DENETİM MODÜLÜ, 1 GİRİŞLİ	150,00 USD.
006 090 051372	ML-1372.SCI BÖLGE DENETİM MODÜLÜ, 1 GİRİŞLİ, KISA DEVRE İZOLATÖRLÜ	175,00 USD.
006 090 001373	ML-1373 3'LÜ I/O MODÜLÜ (2 GİRİŞ / 1 ÇIKIŞ)	300,00 USD.
006 090 051373	ML-1373.SCI 3'LÜ I/O MODÜLÜ (2 GİRİŞ / 1 ÇIKIŞ), KISA DEVRE İZOLATÖRLÜ	350,00 USD.
006 090 001380	ML-1380 KISA DEVRE İZOLATÖR MODÜLÜ	75,00 USD.
006 090 000320	ML-0320 2'Lİ I/O MODÜL KORUMA KUTUSU	125,00 USD.

**MAXLOGIC ANAHTARLAMALI (SMPS) GÜÇ KAYNAĞI ÜNİTESİ**

006 090 000515	ML-0515 ANAHTARLAMALI (SMPS) GÜÇ KAYNAĞI, 5A, A TİPİ KUTU İÇİNDE	550,00 USD.
----------------	--	-------------

**MAXLOGIC AKILLI ADRESLİ YANGIN ALGILAMA VE ALARM SİSTEMLERİ İÇİN AKSESUARLAR**

006 090 001410	ML-1410 ADRESLİ SİREN	140,00 USD.
006 090 051410	ML-1410.SCI ADRESLİ SİREN, KISA DEVRE İZOLATÖRLÜ	160,00 USD.
006 090 001420	ML-1420 ADRESLİ FLAŞÖR	160,00 USD.
006 090 051420	ML-1420.SCI ADRESLİ FLAŞÖR, KISA DEVRE İZOLATÖRLÜ	180,00 USD.
006 090 001430	ML-1430 ADRESLİ FLAŞÖRLÜ SİREN	180,00 USD.
006 090 051430	ML-1430.SCI ADRESLİ FLAŞÖRLÜ SİREN, KISA DEVRE İZOLATÖRLÜ	200,00 USD.
006 090 001710	ML-1710 ADRESLENEBİLİR YANGIN ALARM BUT., RESETFLENEBİLİR, MONTAJ KASASI DAHİL	70,00 USD.
006 090 051710	ML-1710.SCI ADRESLENEBİLİR YANGIN ALR. BUT., KISA DEVRE İZOLATÖRLÜ, RESETFLENEBİLİR	100,00 USD.



Ürün Kodu	Açıklama / Stok Cinsi	Ambalaj (Kutu/Bağ)	Ambalaj (Koli/Çuval)	TL
<b>MUTLUSAN ASPIRATÖR ÇEŞİTLERİ</b>				
001 111 000100 00 00	MUTLUSAN 100 ASPIRATÖR	1 ad.	20	22,680
001 111 000120 00 00	MUTLUSAN 120 ASPIRATÖR	1 ad.	20	26,250
001 111 000150 00 00	MUTLUSAN 150 ASPIRATÖR	1 ad.	20	31,500



### AIRCOL ASPIRATÖR ÇEŞİTLERİ



Ürün Kodu : 029 088 110100

Ürün Adı : AIRCOL 100 ASPIRATÖR

Ambalaj Ad. : 1 ad. / koli: 10

Fiyat : 38,900 TL



Ürün Kodu : 029 088 110120

Ürün Adı : AIRCOL 120 ASPIRATÖR

Ambalaj Ad. : 1 ad. / koli: 10

Fiyat : 43,345 TL



Ürün Kodu : 029 088 110150

Ürün Adı : AIRCOL 150 ASPIRATÖR

Ambalaj Ad. : 1 ad. / koli: 10

Fiyat : 55,570 TL



Ürün Kodu : 029 088 110200

Ürün Adı : AIRCOL 200 ASPIRATÖR

Ambalaj Ad. : 1 ad. / koli: 10

Fiyat : 77,800 TL



Ürün Kodu : 029 088 120100

Ürün Adı : AIRCOL 100 ASPIRATÖR (OTOMATİK PANJURLU)

Ambalaj Ad. : 1 ad. / koli: 10

Fiyat : 68,910 TL



Ürün Kodu : 029 088 120100

Ürün Adı : AIRCOL 120 ASPIRATÖR (OTOMATİK PANJURLU)

Ambalaj Ad. : 1 ad. / koli: 10

Fiyat : 80,020 TL



Ürün Kodu : 029 088 120100

Ürün Adı : AIRCOL 150 ASPIRATÖR (OTOMATİK PANJURLU)

Ambalaj Ad. : 1 ad. / koli: 10

Fiyat : 95,580 TL

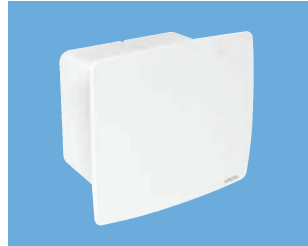

Ürün Kodu : 029 088 130046

Ürün Adı : AIRCOL-LÜX DUVAR VE TAVAN TİPİ ASPIRATÖR

Ambalaj Ad. : 1 ad. / koli: 6

Fiyat : 122,250 TL

## AIRCOL ASPİRATÖR ÇEŞİTLERİ



Ürün Kodu : 029 088 125100  
Ürün Adı : AIRCOL 100-SM ASPİRATÖR (SIVIÇLI MODEL)  
Ambalaj Ad. : 1 ad. / koli: 10  
Fiyat : 46,680 TL



Ürün Kodu : 029 088 125120  
Ürün Adı : AIRCOL 120-SM ASPİRATÖR (SIVIÇLI MODEL)  
Ambalaj Ad. : 1 ad. / koli: 10  
Fiyat : 53,350 TL



Ürün Kodu : 029 088 130020  
Ürün Adı : AIRCOL 20-K ASPİRATÖR (KAPAKLI MODEL)  
Ambalaj Ad. : 1 ad. / koli: 10  
Fiyat : 94,470 TL



Ürün Kodu : 029 088 130025  
Ürün Adı : AIRCOL 25-K ASPİRATÖR (KAPAKLI MODEL)  
Ambalaj Ad. : 1 ad. / koli: 6  
Fiyat : 111,140 TL

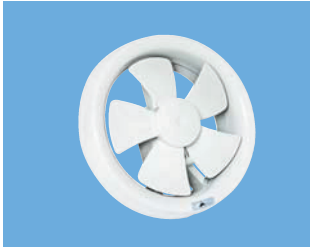

Ürün Kodu : 029 088 130150  
Ürün Adı : AIRCOL 150-K ASPİRATÖR (KAPAKLI MODEL)  
Ambalaj Ad. : 1 ad. / koli: 10  
Fiyat : 72,240 TL



Ürün Kodu : 029 088 130200  
Ürün Adı : AIRCOL 200-K ASPİRATÖR (KAPAKLI MODEL)  
Ambalaj Ad. : 1 ad. / koli: 10  
Fiyat : 80,020 TL

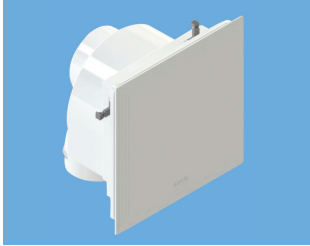

Ürün Kodu : 029 088 130250  
Ürün Adı : AIRCOL 250-2DF DUVAR TAVAN TİPİ ASPİRATÖR  
Ambalaj Ad. : 1 ad. / koli: 6  
Fiyat : 135,000 TL



Ürün Kodu : 029 088 130043  
Ürün Adı : AIRCOL-100KT KANAL TİPİ ASPİRATÖR  
Ambalaj Ad. : 1 ad. / koli: 10  
Fiyat : 33,340 TL



Ürün Kodu : 029 088 130044  
Ürün Adı : AIRCOL-120KT KANAL TİPİ ASPİRATÖR  
Ambalaj Ad. : 1 ad. / koli: 10  
Fiyat : 38,900 TL



Ürün Kodu : 029 088 130045  
Ürün Adı : AIRCOL-150KT KANAL TİPİ ASPİRATÖR  
Ambalaj Ad. : 1 ad. / koli: 10  
Fiyat : 50,010 TL



Ürün Kodu : 029 088 130055  
Ürün Adı : AIRCOL SUMMER TAVAN TİPİ ASPİRATÖR  
Ambalaj Ad. : 1 ad. / koli: 6  
Fiyat : 94,470 TL



Ürün Kodu : 029 088 130042  
Ürün Adı : AIRCOL SPRİNG LIGHT TAVAN TİPİ ASPİRATÖR  
Ambalaj Ad. : 1 ad. / koli: 6  
Fiyat : 111,140 TL



Ürün Kodu : 029 088 131150  
Ürün Adı : AIRCOL-150C MP CAM VE DUVAR TİPİ ASPİRATÖR  
Ambalaj Ad. : 1 ad. / koli: 10  
Fiyat : 105,580 TL



Ürün Kodu : 029 088 132150  
Ürün Adı : AIRCOL-150C OP CAM VE DUVAR TİPİ ASPİRATÖR  
Ambalaj Ad. : 1 ad. / koli: 10  
Fiyat : 122,250 TL

## AIRCOL ASPIRATÖR ÇEŞİTLERİ



Ürün Kodu : 029 088 130049

Ürün Adı : AIRCOL COMFORT 100  
ASPIRATÖR (KROM)

Ambalaj Ad. : 1 ad. / Koli: 10

Fiyat : 52,00 TL



Ürün Kodu : 029 088 140250

Ürün Adı : AIRCOL 250-K ASPIRATÖR  
(TAVAN TİPİ)

Ambalaj Ad. : 1 ad. / Koli: 6

Fiyat : 112,00 TL



Ürün Kodu : 029 088 130120

Ürün Adı : AIRCOL COMFORT 120  
ASPIRATÖR (KROM)

Ambalaj Ad. : 1 ad. / Koli: 10

Fiyat : 60,00 TL



Ürün Kodu : 029 088 136200

Ürün Adı : AIRCOL-200 KF RADYAL  
KANAL İÇİ FANLAR

Ambalaj Ad. : 1 ad.

Fiyat : 255,620 TL



Ürün Kodu : 029 088 130051

Ürün Adı : AIRCOL COMFORT 150  
ASPIRATÖR (KROM)

Ambalaj Ad. : 1 ad. / Koli: 10

Fiyat : 73,00 TL

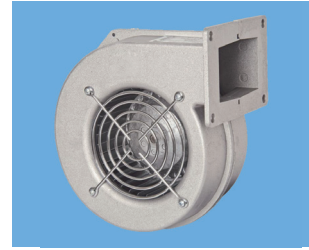

Ürün Kodu : 029 088 137120

Ürün Adı : AIRCOL-120 AKS SALLYANGOZ  
RADYAL FANLAR

Ambalaj Ad. : 1 ad.

Fiyat : 188,940 TL



Ürün Kodu : 029 088 130052

Ürün Adı : AIRCOL COMFORT 200  
ASPIRATÖR (KROM)

Ambalaj Ad. : 1 ad. / Koli: 10

Fiyat : 100,00 TL

## AIRCOL MS SERİSİ AKSİYEL FANLAR

029 088 170200	AIRCOL-200 MS AKSİYEL FAN	1	ad.	155,596
029 088 170250	AIRCOL-250 MS AKSİYEL FAN	1	ad.	183,381
029 088 170300	AIRCOL-300 MS AKSİYEL FAN	1	ad.	205,609

## AIRCOL S SERİSİ KARE MODEL AKSİYEL FANLAR

029 088 175300	AIRCOL-300 S KARE MODEL	1	ad.	216,723
029 088 175400	AIRCOL-400 S KARE MODEL	1	ad.	238,951
029 088 175450	AIRCOL-450 S KARE MODEL	1	ad.	416,775
029 088 075500	AIRCOL-500 S KARE MODEL	1	ad.	450,117

## AIRCOL S SERİSİ SANAYİ TİPİ AKSİYEL FANLAR

029 088 130030	AIRCOL-300 S SANAYİ TİPİ	1	ad.	200,052
029 088 130040	AIRCOL-400 S SANAYİ TİPİ	1	ad.	216,723
029 088 130047	AIRCOL-450 S SANAYİ TİPİ	1	ad.	388,990
029 088 130048	AIRCOL-500 S SANAYİ TİPİ	1	ad.	416,775



Ürün Kodu	Açıklama / Stok Cinsi	Ambalaj (Kutulu)	Ambalaj Birimi	TL
<b>AC AKSİYEL KAPAKLI ASPİRATÖRLER</b>				
080 088 200160	BK160MM KAPAKLI ASPİRATÖR (40WATT 1200 DEV/DAK)	1	ad.	124,902
080 088 200200	BK200MM KAPAKLI ASPİRATÖR (40WAT 1200 DEV/DAK)	1	ad.	146,943
080 088 200250	BK250MM KAPAKLI ASPİRATÖR (50WAT 1100 DEV/DAK)	1	ad.	176,332
080 088 200300	BK300MM KAPAKLI ASPİRATÖR (60WAT 1050 DEV/DAK)	1	ad.	227,762

<b>AC AKSİYEL BACA ASPİRATÖRLER</b>				
080 088 160160	BB160MM BACA ASPİRATÖR (40WATT 1200 DEV/DAK)	1	ad.	120,493
080 088 160200	BB200MM BACA ASPİRATÖR (40WAT 1200 DEV/DAK)	1	ad.	139,596
080 088 160250	BB250MM BACA ASPİRATÖR (50WAT 1100 DEV/DAK)	1	ad.	161,637
080 088 160300	BB300MM BACA ASPİRATÖR (60WAT 1050 DEV/DAK)	1	ad.	205,720

<b>MONOFAZE SANAYİ TİPİ ASPİRATÖRLER</b>				
080 088 002250	BSM250-2K MONOFAZE SANAYİ ASP.(180W 2900 DEV/DAK)	1	ad.	337,969
080 088 000250	BSM250 MONOFAZE SANAYİ ASP.(160W 1480 DEV/DAK)	1	ad.	279,192
080 088 000300	BSM300 MONOFAZE SANAYİ ASP.(180W 1400 DEV/DAK)	1	ad.	293,886
080 088 000350	BSM350 MONOFAZE SANAYİ ASP.(200W 1450 DEV/DAK)	1	ad.	315,927
080 088 000400	BSM400 MONOFAZE SANAYİ ASP.(220W 1450 DEV/DAK)	1	ad.	345,316
080 088 000450	BSM450 MONOFAZE SANAYİ ASP.(240W 1400 DEV/DAK)	1	ad.	367,357
080 088 000500	BSM500 MONOFAZE SANAYİ ASP.(280W 1400 DEV/DAK)	1	ad.	396,746
080 088 000550	BSM550 MONOFAZE SANAYİ ASP.(290W 1400 DEV/DAK)	1	ad.	506,953
080 088 000600	BSM600 MONOFAZE SANAYİ ASP.(310W 1400 DEV/DAK)	1	ad.	506,953

<b>TRİFAZE SANAYİ TİPİ ASPİRATÖRLER</b>				
080 088 102250	BST250-2K TRİFAZE SANAYİ ASP.(180W 2800 DEV/DAK)	1	ad.	337,969
080 088 100250	BST250 TRİFAZE SANAYİ ASP.(100W 1400 DEV/DAK)	1	ad.	279,192
080 088 100300	BST300 TRİFAZE SANAYİ ASP.(125W 1400 DEV/DAK)	1	ad.	293,886
080 088 100350	BST350 TRİFAZE SANAYİ ASP.(175W 1400 DEV/DAK)	1	ad.	315,927
080 088 100400	BST400 TRİFAZE SANAYİ ASP.(170W 1400 DEV/DAK)	1	ad.	345,316
080 088 100450	BST450 TRİFAZE SANAYİ ASP.(210W 1400 DEV/DAK)	1	ad.	367,357
080 088 100500	BST500 TRİFAZE SANAYİ ASP.(230W 1400 DEV/DAK)	1	ad.	396,746
080 088 100550	BST550 TRİFAZE SANAYİ ASP.(220W 1400 DEV/DAK)	1	ad.	506,953
080 088 100600	BST600 TRİFAZE SANAYİ ASP.(200W 1400 DEV/DAK)	1	ad.	506,953

<b>AC RADYAL FANLAR (SAC GÖVDELİ)</b>				
080 088 012550	BDRS 125-50 AC RADYAL FAN (97W 2450 DEV/DAK)	1	ad.	227,762
080 088 012060	BDRS 120-60 AC RADYAL FAN (90W 2400 DEV/DAK)	1	ad.	227,762
080 088 014060	BDRS 140-60 AC RADYAL FAN (160W 2300 DEV/DAK)	1	ad.	264,497
080 088 016060	BDRS 160-60 AC RADYAL FAN (225W 2200 DEV/DAK)	1	ad.	301,233

<b>AC TEK GİRİŞLİ SALLYANGOZ FANLAR</b>				
080 088 000140	OBR140M-2K SALLYANGOZ FAN (250W 2800 D/D)	1	ad.	337,969
080 088 002200	OBR200M-2K SALLYANGOZ FAN (620W 2800 D/D)	1	ad.	367,357
080 088 002400	OBR200M-4K SALLYANGOZ FAN (200W 1450 D/D)	1	ad.	367,357
080 088 002220	OBR200T-2K SALLYANGOZ FAN (600W 2800 D/D)	1	ad.	367,357
080 088 002410	OBR200T-4K SALLYANGOZ FAN (130W 1400 D/D)	1	ad.	367,357
080 088 000260	OBR260M-2K SALLYANGOZ FAN (750W 2800 D/D) GAMAK MOTOR.	1	ad.	1.028,601
080 088 002600	OBR260M-4K SALLYANGOZ FAN (370W 1400 D/D)	1	ad.	462,870

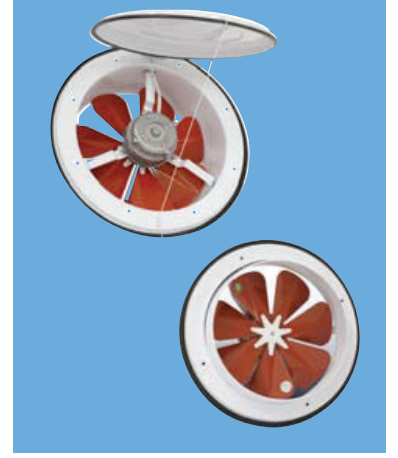





YENİ

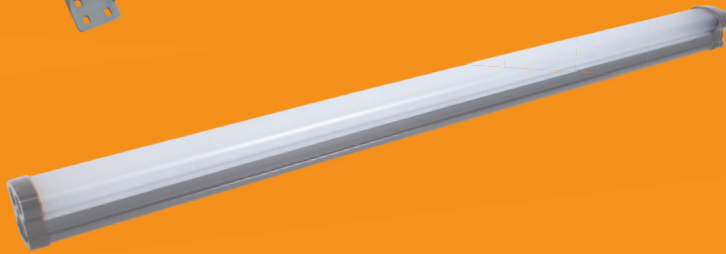
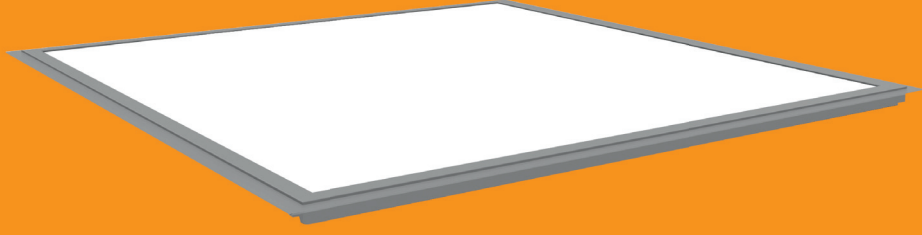

**Mutlusan**  
electric

LED AYDINLATMA  
WALLWASHER

## LED Panel Montaj Tipleri

### LED Panel Installation Types

Bu Üründe  
**OSRAM** LED ve  
**PHILIPS** Driver  
kullanılmıştır.



### Sıva Altı

#### Recessed LED Panel

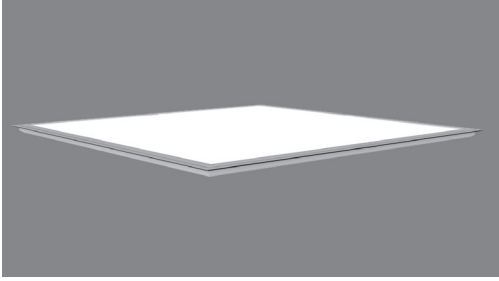

Boyut	595x595x16 mm
Ağırlık	3 kg
Giriş Voltajı	220-240 V AC - 50/60hz
Işık Kaynağı	OSRAM LED
Tüketil Gücü	35 W
Işık Renkleri	3000K, 6500K
Kullanım Ömrü	50.000 h(L70)
Ortam Sıcaklığı	-25 C / +45 C
Işık Akışı	3000 lm
Verimlilik	85 lm/W
Genkrel Geriverim Değeri	≥ 80(typ.85)
Garanti (Yıl)	3

KOD	AÇIKLAMA	Ambalaj	Fiyat
006 087 00 xxxx	60x60 Slim Led Panel	1 ad.	85,000 \$

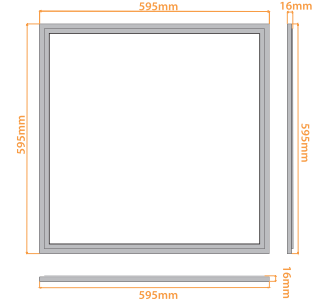

### Clip-in

#### Clip-in

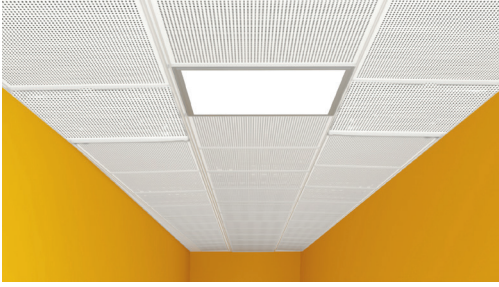

Boyut	597x597x25 mm
Ağırlık	3 kg
Giriş Voltajı	220-240 V AC - 50/60hz
Işık Kaynağı	OSRAM LED
Tüketil Gücü	35 W
Işık Renkleri	3000K, 6500K
Kullanım Ömrü	50.000 h(L70)
Ortam Sıcaklığı	-25 C / +45 C
Işık Akışı	3000 lm
Verimlilik	85 lm/W
Genkrel Geriverim Değeri	≥ 80(typ.85)
Garanti (Yıl)	3

KOD	AÇIKLAMA	Ambalaj	Fiyat
006 087 00 xxxx	60x60 Slim Led Panel	1 ad.	85,000 \$
999 999 999322	Clip-in Aparat 60x60	1 ad.	14,055 \$

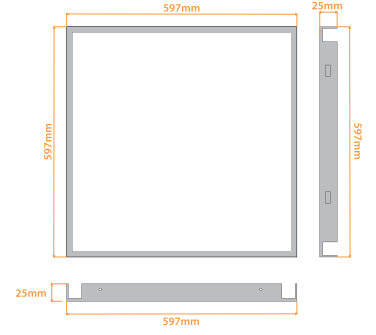

### Alçı Tavan

#### LED Panel for gypsum ceiling



Boyut	595x595x16 mm
Ağırlık	3 kg
Giriş Voltajı	220-240 V AC - 50/60hz
Işık Kaynağı	OSRAM LED
Tüketil Gücü	35 W
Işık Renkleri	3000K, 6500K
Kullanım Ömrü	50.000 h(L70)
Ortam Sıcaklığı	-25 C / +45 C
Işık Akışı	3000 lm
Verimlilik	85 lm/W
Genkrel Geriverim Değeri	≥ 80(typ.85)
Garanti (Yıl)	3

KOD	AÇIKLAMA	Ambalaj	Fiyat
006 087 00 xxxx	60x60 Slim Led Panel	1 ad.	85,000 \$
999 999 999320	Alçıpan Aparat 60x60	1 ad.	8,433 \$

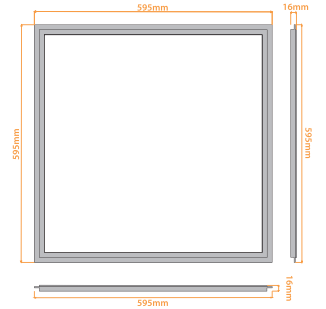

### Sıva Üstü

#### Surface Mounted LED Panel



Boyut	597x597x50 mm
Ağırlık	3 kg
Giriş Voltajı	220-240 V AC - 50/60hz
Işık Kaynağı	OSRAM LED
Tüketil Gücü	35 W
Işık Renkleri	3000K, 6500K
Kullanım Ömrü	70.000 h(L70)
Ortam Sıcaklığı	-25 C / +45 C
Işık Akışı	3000 lm
Verimlilik	85 lm/W
Genkrel Geriverim Değeri	≥ 80(typ.85)
Garanti (Yıl)	3

KOD	AÇIKLAMA	Ambalaj	Fiyat
006 087 00 xxxx	60x60 Slim Led Panel	1 ad.	85,000 \$
999 999 999321	S/Ü Aparat 60x60	1 ad.	19,678 \$

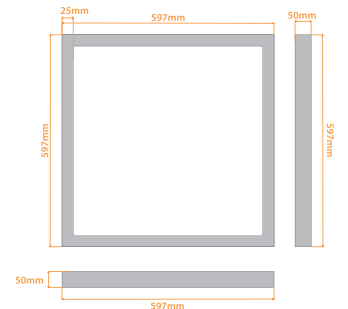

**RENK KODU:** Sonu xxxx ile belirtilen kodlar için ışık renk kodunu lütfen siparişte bildiriniz.

**Aynı Markalı Ürünün 30x30 30x60 30x115 Ölçüleri Bulunmaktadır. Bu Ürünler için Fiyat İsteyiniz.**

**BACKLIGHT Kasa**  
**Bu Üründe**  
**TRİDONİC ve PHILIPS**  
**Driver Kullanılmıştır.**

**YENİ**

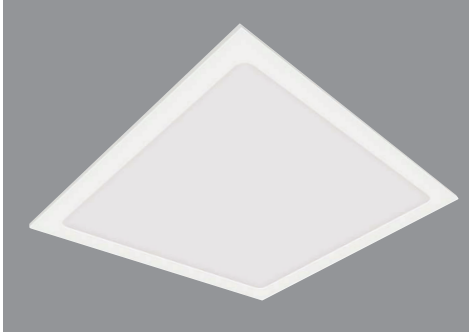

SIVAALTI  
 RECESSED **60x60**

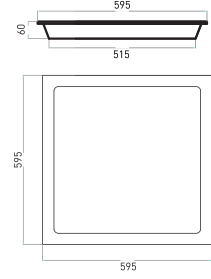

KOD	AÇIKLAMA	LUMEN	GÜÇ	IŞIK SICAKLIĞI	AMBALAJ	FİYAT
090 039 500160	60x60 S/A Led Panel (Asma Tavan)	3000 lm	30W	3000K - 6500K	1ad.	81,52 USD.
090 039 500260	60x60 S/A Led Panel (Alçıpan Tavan)	3000 lm	30W	3000K - 6500K	1ad.	92,77 USD.
090 039 500360	60x60 S/A Led Panel (clip-in Tavan)	3000 lm	30W	3000K - 6500K	1ad.	92,77 USD.



SIVAALTI  
 RECESSED **30x30**

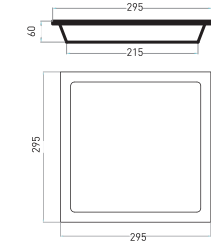

KOD	AÇIKLAMA	LUMEN	GÜÇ	IŞIK SICAKLIĞI	AMBALAJ	FİYAT
090 039 500130	30x30 S/A Led Panel (Asma Tavan)	800 lm	10W	3000K - 6500K	1ad.	56,22 USD.
090 039 500230	30x30 S/A Led Panel (Alçıpan Tavan)	800 lm	10W	3000K - 6500K	1ad.	67,47 USD.
090 039 500330	30x30 S/A Led Panel (clip-in Tavan)	800 lm	10W	3000K - 6500K	1ad.	67,47 USD.



SIVAÜSTÜ  
 SURFACE **60x60**

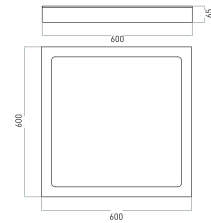

KOD	AÇIKLAMA	LUMEN	GÜÇ	IŞIK SICAKLIĞI	AMBALAJ	FİYAT
090 039 510060	60x60 S/Ü Led Panel	3000 lm	30W	3000K - 6500K	1ad.	105,00 USD.



SIVAÜSTÜ  
 SURFACE **30x30**

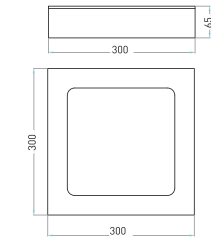

KOD	AÇIKLAMA	LUMEN	GÜÇ	IŞIK SICAKLIĞI	AMBALAJ	FİYAT
090 039 510030	30x30 S/Ü Led Panel	800 lm	10W	3000K - 6500K	1ad.	67,47 USD.

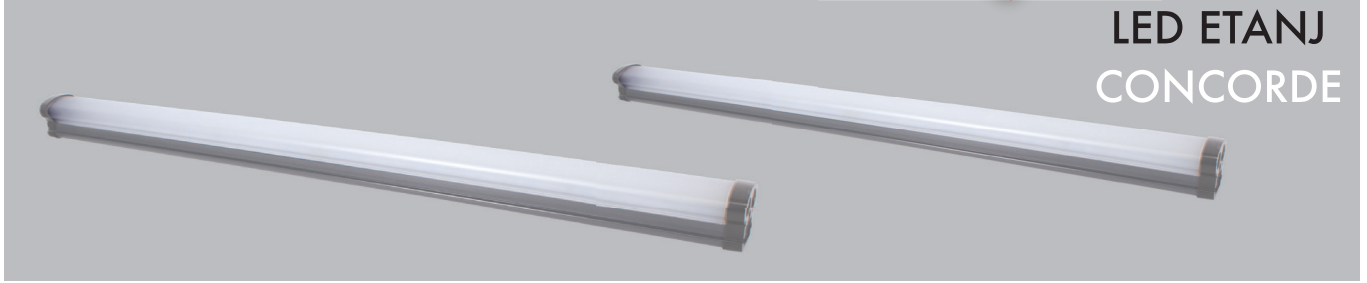

## LED ETANJ CONCORDE

### ÜRÜN AÇIKLAMASI:

POLİKARBON MALZEME, IP66 KORUMA SINIFI, MONOBLOK GÖVDE, TAK ÇIKAR ÖZELLİKLİ, KOLAY MONTAJ, LED ARMATÜR, 220V BESLEMELİ

### KULLANIM ALANLARI:

OTOPARK, SUNDURMA, TRAFİKO ODASI, PANO ODASI, KONTEYNER, AÇIK ALAN, KAZAN DAİRESİ, POMPA ODASI, KLİMA SANTRALLERİ



KOD	AÇIKLAMA	BOYUT	LUMEN	GÜÇ	IŞIK SICAKLIĞI	AMBALAJ	FİYAT
016 039 106020	Concord Led PC Etanj Armatür	60 cm	2640 lm	20W	6500K	1ad.	56,222 USD.
016 039 112028	Concord Led PC Etanj Armatür	120 cm	3520 lm	28W	6500K	1ad.	80,116 USD.



KOD	AÇIKLAMA	BOYUT	LUMEN	GÜÇ	IŞIK SICAKLIĞI	AMBALAJ	FİYAT
016 039 006010	PC Led Etanj Armatür	60 cm	1300 lm	10W	6500K	2ad.	58,386 USD.
016 039 006020	PC Led Etanj Armatür	60 cm	2400 lm	20W	6500K	2ad.	68,113 USD.
016 039 012020	PC Led Etanj Armatür	120 cm	2600 lm	20W	6500K	2ad.	86,947 USD.
016 039 012040	PC Led Etanj Armatür	120 cm	4800 lm	40W	6500K	2ad.	107,074 USD.



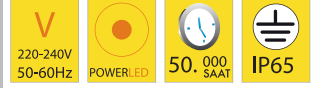

KOD	AÇIKLAMA	BOYUT	LUMEN	GÜÇ	IŞIK SICAKLIĞI	AMBALAJ	FİYAT
016 040 100001	Wallwasher 12 Ledli	35 cm	900 lm	12W	3000K	1ad.	59,033 USD.
016 040 100002	Wallwasher 12 Ledli	35 cm	963 lm	12W	6500K	1ad.	59,033 USD.
016 040 100003	Wallwasher 18 Ledli	50 cm	1550 lm	18W	3000K	1ad.	80,959 USD.
016 040 100004	Wallwasher 18 Ledli	50 cm	1605 lm	18W	6500K	1ad.	80,959 USD.
016 040 100005	Wallwasher 36 Ledli	100 cm	3000 lm	32W	3000K	1ad.	130,715 USD.
016 040 100006	Wallwasher 36 Ledli	100 cm	3210 lm	32W	6500K	1ad.	130,715 USD.

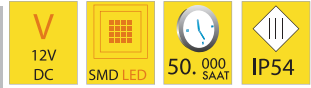
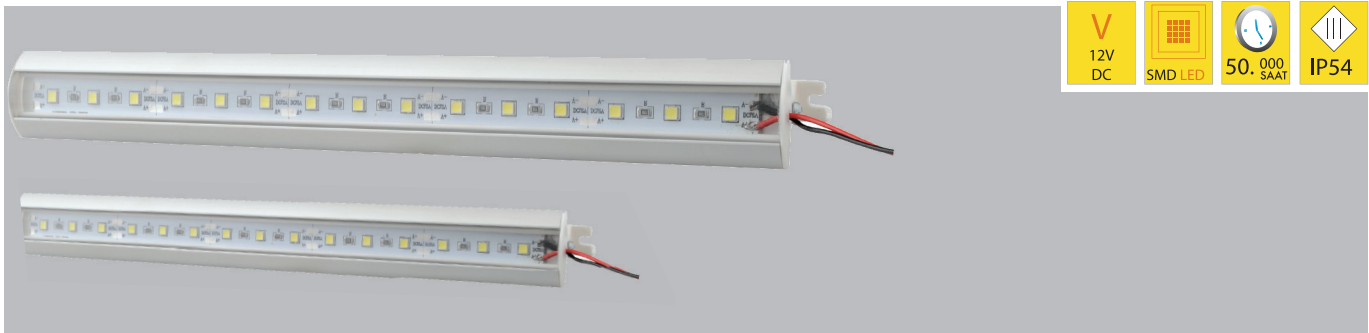

KOD	AÇIKLAMA	BOYUT	GÜÇ	IŞIK SICAKLIĞI	AMBALAJ	FİYAT
016 040 200001	Led Bar (Led Trafosu Hariç)	25 cm	4W	3500K	1ad.	6,156 USD.
016 040 200002	Led Bar (Led Trafosu Hariç)	25 cm	4W	6000K	1ad.	6,156 USD.
016 040 200003	Led Bar (Led Trafosu Hariç)	50 cm	7,5W	3500K	1ad.	10,668 USD.
016 040 200004	Led Bar (Led Trafosu Hariç)	50 cm	7,5W	6000K	1ad.	10,668 USD.
016 040 200005	Led Bar (Led Trafosu Hariç)	75 cm	10,5W	3500K	1ad.	17,035 USD.
016 040 200006	Led Bar (Led Trafosu Hariç)	75 cm	10,5W	6000K	1ad.	17,035 USD.
016 040 200007	Led Bar (Led Trafosu Hariç)	100 cm	15W	3500K	1ad.	18,637 USD.
016 040 200008	Led Bar (Led Trafosu Hariç)	100 cm	15W	6000K	1ad.	18,637 USD.



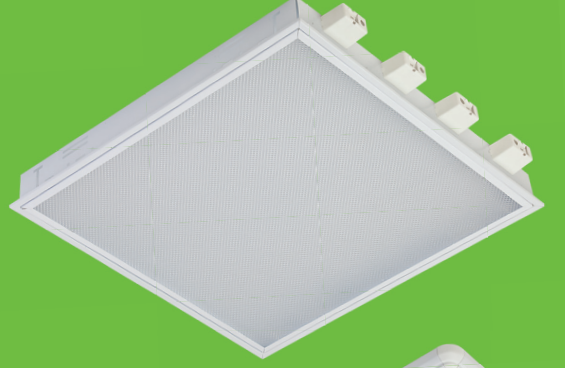

KIRILMAZ  
POLİKARBON  
CAM ve GÖVDE

**Mutlusan**  
electric

AYDINLATMA

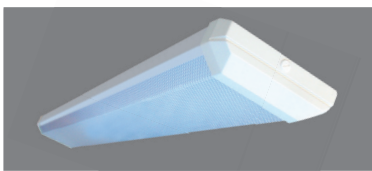
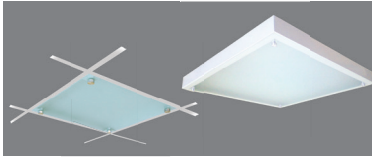
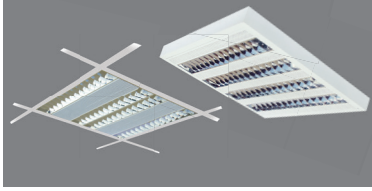
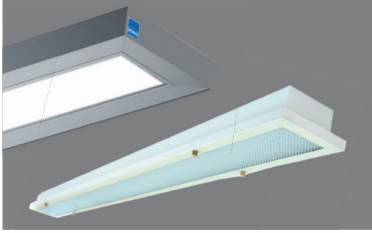
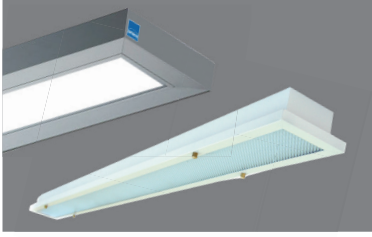

Ürün Kodu	Açıklama / Stok Cinsi	Ambalaj (Kutulu)	Ambalaj Birimi	TL
<b>T 8 S/Ü ÇİFTPARABOLİK ARMATÜRLER (ELEKTRONİK BALANSTLI)</b>				
090 038 000118	TIL-118-SM S/Ü 1X18 ÇİFTPARABOLİK ARMATÜR (ELEKTRONİK BALANSTLI)	1	ad.	103,448
090 038 000218	TIL-218-SM S/Ü 2X18 ÇİFTPARABOLİK ARMATÜR (ELEKTRONİK BALANSTLI)	1	ad.	106,259
090 038 000418	TIL-418-SM S/Ü 4X18 ÇİFTPARABOLİK ARMATÜR (ELEKTRONİK BALANSTLI)	1	ad.	116,154
090 038 000136	TIL-136-SM S/Ü 1X36 ÇİFTPARABOLİK ARMATÜR (ELEKTRONİK BALANSTLI)	1	ad.	116,154
090 038 000236	TIL-236-SM S/Ü 2X36 ÇİFTPARABOLİK ARMATÜR (ELEKTRONİK BALANSTLI)	1	ad.	119,190
<b>T 8 S/A ÇİFTPARABOLİK ARMATÜRLER (ELEKTRONİK BALANSTLI)</b>				
090 038 100118	TIL-118-RM S/A 1X18 ÇİFTPARABOLİK ARMATÜR (ELEKTRONİK BALANSTLI)	1	ad.	102,464
090 038 100218	TIL-218-RM S/A 2X18 ÇİFTPARABOLİK ARMATÜR (ELEKTRONİK BALANSTLI)	1	ad.	105,275
090 038 100418	TIL-418-RM S/A 4X18 ÇİFTPARABOLİK ARMATÜR (ELEKTRONİK BALANSTLI)	1	ad.	111,937
090 038 100136	TIL-136-RM S/A 1X36 ÇİFTPARABOLİK ARMATÜR (ELEKTRONİK BALANSTLI)	1	ad.	116,154
090 038 100236	TIL-236-RM S/A 2X36 ÇİFTPARABOLİK ARMATÜR (ELEKTRONİK BALANSTLI)	1	ad.	114,973
<b>T 8 S/Ü PRİZMATİK ARMATÜRLER (ELEKTRONİK BALANSTLI)</b>				
090 038 200218	TIDA-218-SM S/Ü 2X18 PRİZMATİK ARMATÜR (ELEKTRONİK BALANSTLI)	1	ad.	129,169
090 038 200418	TIDA-418-SM S/Ü 4X18 PRİZMATİK ARMATÜR (ELEKTRONİK BALANSTLI)	1	ad.	142,747
090 038 200236	TIDA-236-SM S/Ü 2X36 PRİZMATİK ARMATÜR (ELEKTRONİK BALANSTLI)	1	ad.	143,731
<b>T 8 S/A PRİZMATİK ARMATÜRLER (ELEKTRONİK BALANSTLI)</b>				
090 038 300218	TIDA-218-RM S/A 2X18 PRİZMATİK ARMATÜR (ELEKTRONİK BALANSTLI)	1	ad.	118,796
090 038 300418	TIDA-418-RM S/A 4X18 PRİZMATİK ARMATÜR (ELEKTRONİK BALANSTLI)	1	ad.	137,181
090 038 300236	TIDA-236-RM S/A 2X36 PRİZMATİK ARMATÜR (ELEKTRONİK BALANSTLI)	1	ad.	138,671
<b>T 8 S/Ü OPAL ARMATÜRLER (ELEKTRONİK BALANSTLI)</b>				
090 038 400418	TIDA-418-SM S/Ü 4X18 OPAL ARMATÜR (ELEKTRONİK BALANSTLI)	1	ad.	142,747
090 038 400236	TIDA-236-SM S/Ü 2X36 OPAL ARMATÜR (ELEKTRONİK BALANSTLI)	1	ad.	143,731
<b>T 8 S/A OPAL ARMATÜRLER (ELEKTRONİK BALANSTLI)</b>				
090 038 500418	TIDA-418-RM S/A 4X18 OPAL ARMATÜR (ELEKTRONİK BALANSTLI)	1	ad.	152,164
090 038 500236	TIDA-236-RM S/A 2X36 OPAL ARMATÜR (ELEKTRONİK BALANSTLI)	1	ad.	152,810
<b>T 5 S/Ü ÇİFTPARABOLİK ARMATÜRLER (ELEKTRONİK BALANSTLI)</b>				
090 038 600214	TIL-214-SM S/Ü 2X14 ÇİFTPARABOLİK ARMATÜR (ELEKTRONİK BALANSTLI)	1	ad.	160,232
090 038 600414	TIL-414-SM S/Ü 4X14 ÇİFTPARABOLİK ARMATÜR (ELEKTRONİK BALANSTLI)	1	ad.	182,158
<b>T 5 S/A ÇİFTPARABOLİK ARMATÜRLER (ELEKTRONİK BALANSTLI)</b>				
090 038 700214	TIL-214-RM S/A 2X14 ÇİFTPARABOLİK ARMATÜR (ELEKTRONİK BALANSTLI)	1	ad.	160,232
090 038 700414	TIL-414-RM S/A 4X14 ÇİFTPARABOLİK ARMATÜR (ELEKTRONİK BALANSTLI)	1	ad.	182,158
<b>S/A-S/Ü DECORATİF TEMPERLİ CAM ARMATÜRLER (ELEKTRONİK BALANSTLI)</b>				
090 038 140414	TIGS-414-SM S/Ü 4X14 TEMPERLİ CAM ARMATÜR (ELEKTRONİK BALANSTLI)	1	ad.	75,900 USD.
090 038 110414	TIGS-414-RM S/A 4X14 TEMPERLİ CAM ARMATÜR (ELEKTRONİK BALANSTLI)	1	ad.	75,900 USD.
<b>AKRİLİK CAM - SAC GÖVDE ARMATÜR (ELEKTRONİK BALANSTLI)(TRİDONİK)</b>				
090 038 130136	TLL-136 1X36 IP 44 AKRİLİK CAM ARMATÜR(TRİDONİK)	1	ad.	122,738

Ürün Kodu	Açıklama / Stok Cinsi	Ambalaj (Kutulu)	Ambalaj Birimi	TL
<b>T 8 S/Ü ÇİFTPARABOLİK ARMATÜRLER (MEKANİK BALANSTLI)</b>				
090 039 171218	2X18 W S/Ü ÇİFT PARABOLİK ARMATÜR	1	ad.	59,033
090 039 151418	4X18 W S/Ü ÇİFT PARABOLİK ARMATÜR	1	ad.	82,646
090 039 171236	2X36 W S/Ü ÇİFT PARABOLİK ARMATÜR	1	ad.	82,646

<b>T 8 S/A ÇİFTPARABOLİK ARMATÜRLER (MEKANİK BALANSTLI)</b>				
090 039 161218	2X18 W S/A ÇİFT PARABOLİK ARMATÜR	1	ad.	57,627
090 039 141418	4X18 W S/A ÇİFT PARABOLİK ARMATÜR	1	ad.	81,240
090 039 161236	2X36 W S/A ÇİFT PARABOLİK ARMATÜR	1	ad.	82,084

<b>T 8 S/Ü PRİZMATİK ARMATÜRLER (MEKANİK BALANSTLI)</b>				
090 039 172218	2X18 W S/Ü PRİZMATİK ARMATÜR	1	ad.	83,160
090 039 152418	4X18 W S/Ü PRİZMATİK ARMATÜR	1	ad.	116,944
090 039 172236	2X36 W S/Ü PRİZMATİK ARMATÜR	1	ad.	116,944

<b>T 8 S/A PRİZMATİK ARMATÜRLER (MEKANİK BALANSTLI)</b>				
090 039 162218	2X18 W S/A PRİZMATİK ARMATÜR	1	ad.	80,561
090 039 142418	4X18 W S/A PRİZMATİK ARMATÜR	1	ad.	114,345
090 039 162236	2X36 W S/A PRİZMATİK ARMATÜR	1	ad.	114,345

<b>T 8 S/Ü OPAL ARMATÜRLER (MEKANİK BALANSTLI)</b>				
090 039 170218	2X18 W S/Ü OPAL ARMATÜR	1	ad.	88,358
090 039 150418	4X18 W S/Ü OPAL ARMATÜR	1	ad.	127,339
090 039 170236	2X36 W S/Ü OPAL ARMATÜR	1	ad.	127,339

<b>T 8 S/A OPAL ARMATÜRLER (MEKANİK BALANSTLI)</b>				
090 039 160218	2X18 W S/A OPAL ARMATÜR	1	ad.	85,759
090 039 140418	4X18 W S/A OPAL ARMATÜR	1	ad.	124,740
090 039 160236	2X36 W S/A OPAL ARMATÜR	1	ad.	124,740

### YENİ YÜKSEK TAVAN AYDINLATMA ARMATÜRLERİ

090 039 400228	2X28W YÜKSEK TAVAN TL5 ARMATÜR	1	ad.	298,416
090 039 400428	4X28W YÜKSEK TAVAN TL5 ARMATÜR	1	ad.	459,195
090 039 400254	2X54W YÜKSEK TAVAN TL5 ARMATÜR	1	ad.	298,416
090 039 400454	4X54W YÜKSEK TAVAN TL5 ARMATÜR	1	ad.	459,195
090 039 400235	2X35W YÜKSEK TAVAN TL5 ARMATÜR	1	ad.	363,000
090 039 400435	4X35W YÜKSEK TAVAN TL5 ARMATÜR	1	ad.	597,438
090 039 400280	2X80W YÜKSEK TAVAN TL5 ARMATÜR	1	ad.	393,250
090 039 400480	4X80W YÜKSEK TAVAN TL5 ARMATÜR	1	ad.	674,575

### İTHAL PROJEKTÖRLER

888 038 273150	150 W PROJEKTÖR (NORMAL)	1	ad.	8,433 USD.
888 038 273500	500 W PROJEKTÖR (NORMAL)	1	ad.	10,317 USD.
888 038 273100	1000 W PROJEKTÖR (NORMAL)	1	ad.	21,139 USD.

### LEDLİ PROJEKTÖR

888 111 000038	10W SICAK BEYAZ LEDLİ PROJEKTÖR	1	ad.	15,960 USD.
888 111 000039	20W SICAK BEYAZ LEDLİ PROJEKTÖR	1	ad.	26,901 USD.
888 111 000040	30W SICAK BEYAZ LEDLİ PROJEKTÖR	1	ad.	36,383 USD.

### S TİPİ POLYESTER CADDE ARMATÜRLERİ

066 038 910001	T-1000-01 S-3 160W E27 DUYLU BOŞ CADDE ARMATÜRÜ (KARE GÖVDE)	1	ad.	42,933
066 038 910002	T-1000-02 S-3 125W BALASTLI CADDE ARMATÜRÜ	1	ad.	63,058
066 038 910003	T-1000-03 S-3 160W E27 DUYLU BOŞ CADDE ARMATÜRÜ (OVAL GÖVDE)	1	ad.	41,591
066 038 910004	T-1000-04 KONSOL BORU	1	ad.	7,782

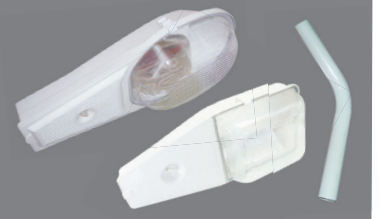
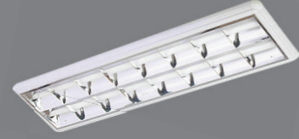
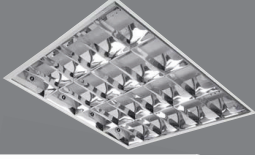



Ürün Kodu	Açıklama / Stok Cinsi	Ambalaj (Kutu/Bağ)	Ambalaj (Koli/Çuval)	TL
-----------	-----------------------	--------------------	----------------------	----

### ETANJ ARMATÜRLER (AKRİLİK CAM-PC GÖVDE)

066 038 910118	T-2000-04 1X18 ETANJ ARMATÜR (AKRİLİK CAM-PC GÖVDE)(MEKANİK BALANS)	2 ad.	12	42,666
066 038 910218	T-2000-03 2X18 ETANJ ARMATÜR (AKRİLİK CAM-PC GÖVDE)(MEKANİK BALANS)	2 ad.	12	49,434
066 038 910136	T-2000-02 1X36 ETANJ ARMATÜR (AKRİLİK CAM-PC GÖVDE)(MEKANİK BALANS)	2 ad.	12	52,899
066 038 910236	T-2000-01 2X36 ETANJ ARMATÜR (AKRİLİK CAM-PC GÖVDE)(MEKANİK BALANS)	2 ad.	12	63,185

### ETANJ ARMATÜRLER (AKRİLİK CAM-PC GÖVDE) (ELEKTRONİK BALANSTLI)

090 038 190136	1X36 ETANJ ARMATÜR (AKRİLİK CAM-PC GÖVDE)(ELEKTRONİK BALANSTLI)	2 ad.	12	62,665
090 038 190236	2X36 ETANJ ARMATÜR (AKRİLİK CAM-PC GÖVDE)(ELEKTRONİK BALANSTLI)	2 ad.	12	70,277

### ETANJ ARMATÜRLER PC CAM VE GÖVDE (MEKANİK BALANSTLI)

090 038 210118	1X18 W ETANJ ARMATÜR PC(MEKANİK BALANSTLI)	2 ad.	12	42,166
090 038 210136	1X36 W ETANJ ARMATÜR PC(MEKANİK BALANSTLI)	2 ad.	12	56,784
090 038 210218	2X18 W ETANJ ARMATÜR PC(MEKANİK BALANSTLI)	2 ad.	12	46,383
090 038 210236	2X36 W ETANJ ARMATÜR PC(MEKANİK BALANSTLI)	2 ad.	12	67,354

### POLİKARBON CAM ETANJ ARMATÜRLER (ELEKTRONİK BALANSTLI)

090 038 120118	TIBA-118 1X18 IP 65 ETANJ ARMT (ELEKTRONİK BALANSTLI)	2 ad.	12	48,300
090 038 120218	TIBA-218 2X18 IP 65 ETANJ ARMT (ELEKTRONİK BALANSTLI)	2 ad.	12	55,813
090 038 120136	TIBA-136 1X36 IP 65 ETANJ ARMT (ELEKTRONİK BALANSTLI)	2 ad.	12	65,077
090 038 120236	TIBA-236 2X36 IP 65 ETANJ ARMT ELEKTRONİK BALANSTLI)	2 ad.	12	73,088

### YENİ ETANJ ARMATÜR PC CAM VE GÖVDE (ELEKTRONİK BALANSTLI) (TRİDONİK)

090 038 220118	1X18 W ETANJ ARMATÜR PC(ELEKTRONİK BALANSTLI)(TRİDONİK)	2 ad.	12	73,088
090 038 220136	1X36 W ETANJ ARMATÜR PC(ELEKTRONİK BALANSTLI)(TRİDONİK)	2 ad.	12	87,706
090 038 220218	2X18 W ETANJ ARMATÜR PC(ELEKTRONİK BALANSTLI)(TRİDONİK)	2 ad.	12	77,305
090 038 220236	2X36 W ETANJ ARMATÜR PC(ELEKTRONİK BALANSTLI)(TRİDONİK)	2 ad.	12	101,087

### ETANJ ARMATÜR (AKRİLİK CAM-FİBERCLAS GÖVDE) MEKANİK BALANSTLI

066 038 200118	1X18 W ETANJ ARM. (AKRİLİK CAM-FİBERCLAS GÖVDE) MEK. BALANSTLI	1 ad.	6	61,875
066 038 200218	1X36 W ETANJ ARM. (AKRİLİK CAM-FİBERCLAS GÖVDE) MEK. BALANSTLI	1 ad.	6	81,950
066 038 200136	2X18 W ETANJ ARM. (AKRİLİK CAM-FİBERCLAS GÖVDE) MEK. BALANSTLI	1 ad.	6	67,375
066 038 200236	2X36 W ETANJ ARM. (AKRİLİK CAM-FİBERCLAS GÖVDE) MEK. BALANSTLI	1 ad.	6	88,550

### YENİ BATTEN TSC OKUL TİPİ ARMATÜRLER (MEKANİK BALANSTLI)

078 038 050118	1X18 W BATTEN TSC OKUL TİPİ ARMATÜR (MEKANİK BALANSTLI)	1 ad.	6	54,057
078 038 050136	1X36 W BATTEN TSC OKUL TİPİ ARMATÜR (MEKANİK BALANSTLI)	1 ad.	6	69,209
078 038 050218	2X18 W BATTEN TSC OKUL TİPİ ARMATÜR (MEKANİK BALANSTLI)	1 ad.	6	66,313
078 038 050236	2X36 W BATTEN TSC OKUL TİPİ ARMATÜR (MEKANİK BALANSTLI)	1 ad.	6	82,871

### YENİ BATTEN TSC OKUL TİPİ ARMATÜRLER (ELEKTRONİK BALANSTLI) (TRİDONİK)

078 040 050118	1X18 W BATTEN TSC OKUL TİPİ ARMATÜR (ELEKTRONİK BALANSTLI)	1 ad.	6	91,782
078 040 050136	1X36 W BATTEN TSC OKUL TİPİ ARMATÜR (ELEKTRONİK BALANSTLI)	1 ad.	6	107,524
078 040 050218	2X18 W BATTEN TSC OKUL TİPİ ARMATÜR (ELEKTRONİK BALANSTLI)	1 ad.	6	106,849
078 040 050236	2X36 W BATTEN TSC OKUL TİPİ ARMATÜR (ELEKTRONİK BALANSTLI)	1 ad.	6	116,435

### BATTEN TMS BANT TİPİ T8 ARMATÜR (MEKANİK BALANSTLI)

078 038 900118	900118 1x18 W TMS	1 ad.	6	26,180
078 038 900136	900136 1x36 W TMS	1 ad.	6	28,820
078 038 900218	900218 2x18 W TMS	1 ad.	6	28,930
078 038 900236	900236 2x36 W TMS	1 ad.	6	47,960

# 5 ADET 9 WATT ► 8 SETE KADAR EKLENEBİLİR, LAMBA SETİ



Sağlam ve pratik bağlantı yapısı ile kolay ve hızlı kurulum imkanı sunan, Olumsuz doğa koşullarına karşı son derece dayanıklı, Özel tasarımı sayesinde eklenebilir ve uzatılabilir LED Lamba Seti. Her türlü iç ve dış mekan aydınlatma uygulamaları için ideal çözüm!

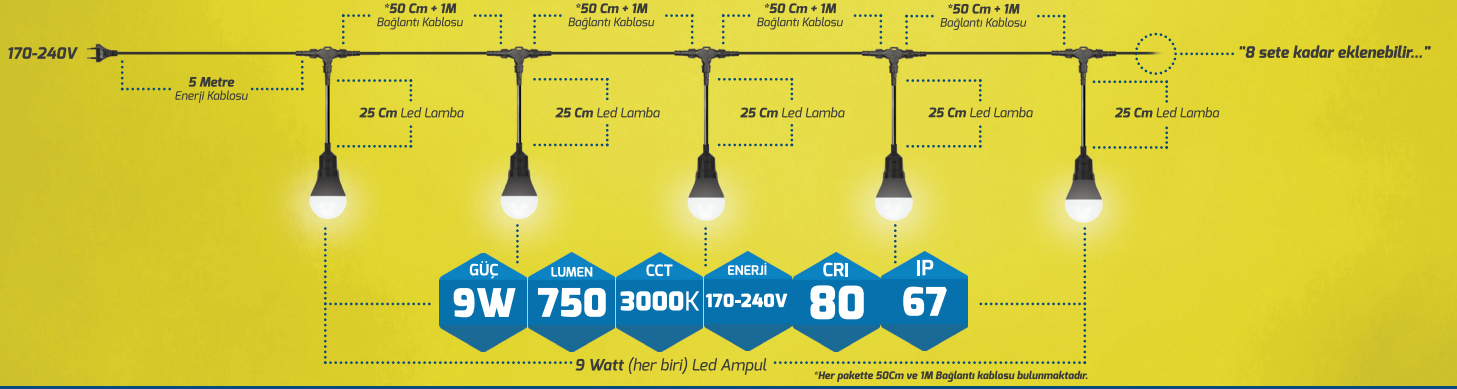

Radar Sensörlü

**YENİ**  
ÜRÜNLERİMİZ

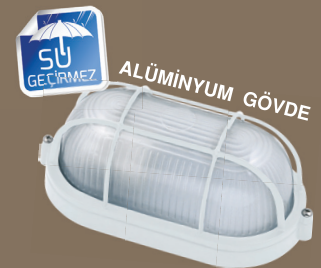
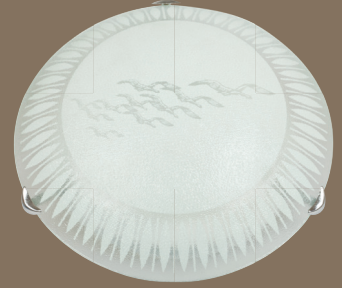



## Radar Sensörlü



**YENİ**  
ÜRÜNLERİMİZ

### LED Mikrodalga (Radar) Sensörlü Tavan Aydınlatma

Güç: 15W

Çalışma Voltajı: 85V-270V

Ölçü(MM) :260 MM

Metal Taban / Plastik Gövde

LED :SMD 57/30

Lümen: 900-980 lm

Renk :6500k

Çalışma süresi : 50 000h

Radar sensörü Algılama : Çap: = 10-12 M

Yüksek duyarlılık

Çalışma açısı :180° x 360°

**KOLİ ADEDİ : 20**

Fiyat:  
**33,35 USD**

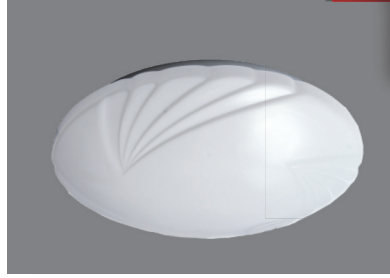

Ürün Kodu: 016 038 250081  
Ürün Adı : Radar Sens. Led Arm Sofia-1



Ürün Kodu: 016 038 250082  
Ürün Adı : Radar Sens. Led Arm Sofia-2



Ürün Kodu: 016 038 250083  
Ürün Adı : Radar Sens. Led Arm Sofia-3



Ürün Kodu: 016 038 250084  
Ürün Adı : Radar Sens. Led Arm Sofia-4

### LED Tavan Aydınlatma

Metal Taban / Plastik Gövde

Güç: 15W

Çalışma Voltajı: 85V-270V

Ölçü(MM) :260 MM

LED :SMD 57/30

Lümen: 900-980 lm

Renk :6500k

Çalışma süresi : 50 000 S

**KOLİ ADEDİ : 20**

Fiyat:  
**21,55 USD**



Ürün Kodu: 016 038 250071  
Ürün Adı : Led Aydınlatma Sidem-1



Ürün Kodu: 016 038 250072  
Ürün Adı : Led Aydınlatma Sidem-2



Ürün Kodu: 016 038 250073  
Ürün Adı : Led Aydınlatma Sidem-3



Ürün Kodu: 016 038 250074  
Ürün Adı : Led Aydınlatma Sidem-4

## ARMATÜR ÇEŞİTLERİMİZ



Ürün Kodu : 001 038 250022 00 00  
Ürün Adı : 360 DRC.SENSÖRLÜ TAVAN  
GLOP ARMT.(2X25 W)  
Ambalaj Ad. : 10  
Fiyat : 37,950 TL  
Renk :



Ürün Kodu : 016 038 250044  
Ürün Adı : SENSÖRLÜ 80 LEDLİ  
ARMATÜR  
Ambalaj Ad. : 10  
Fiyat : 103,307 TL **PİL DAHİL**  
Renk :



Ürün Kodu : 001 038 250025 00 00  
Ürün Adı : COMBO LEDLİ SENSÖRLÜ  
TAVAN ARMATÜRÜ 2X25W  
Ambalaj Ad. : 10  
Fiyat : 88,549 TL **PİL DAHİL**  
Renk :



Ürün Kodu : 016 038 600080  
Açıklama : SENSÖRLÜ 80 LEDLİ  
KROM ARMATÜR  
Ambalaj Ad. : 10  
Fiyat : 118,065 TL **PİL DAHİL**  
Renk :

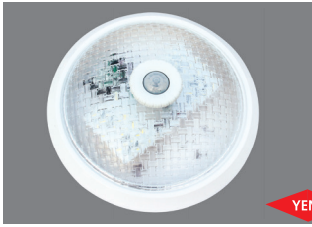

Ürün Kodu : 016 038 250061  
Ürün Adı : LEDLİ SENSÖRLÜ  
TAVAN ARMATÜRÜ  
Ambalaj Ad. : 10  
Fiyat : 84,332 TL  
Renk :



Ürün Kodu : 078 039 500100  
Ürün Adı : SENSÖRLÜ DUVAR APLİK  
E27 DUYLU  
Ambalaj Ad. : 20  
Fiyat : 36,544 TL  
Renk :

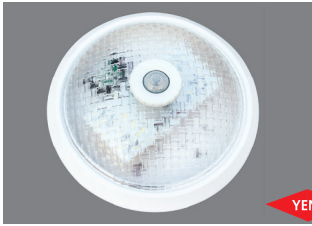

Ürün Kodu : 016 038 250060  
Ürün Adı : LEDLİ SENSÖRLÜ  
TAVAN ARMATÜRÜ (PİLLİ)  
Ambalaj Ad. : 10  
Fiyat : 106,821 TL  
Renk :



Ürün Kodu : 078 039 500110  
Ürün Adı : SENSÖRLÜ DUVAR APLİK  
LEDLİ  
Ambalaj Ad. : 20  
Fiyat : 56,222 TL  
Renk :

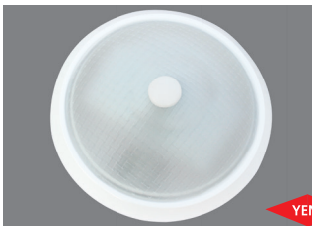

Ürün Kodu : 016 038 250062  
Ürün Adı : LEDLİ CAM TAVAN ARMATÜRÜ  
Ambalaj Ad. : 10  
Fiyat : 57,627 TL  
Renk :

## ARMATÜR ÇEŞİTLERİMİZ



Ürün Kodu : 016 038 250031  
 Ürün Adı : TAVAN GLOP ARMATÜRÜ  
 (MİNİ) 75W  
 Ambalaj Ad. : 48  
 Fiyat : 4,285 TL  
 Renk :



Ürün Kodu : 001 038 120101 00 00  
 Ürün Adı : ORKİDE TAVAN ARMATÜRÜ  
 Ambalaj Ad. : 48  
 Fiyat : 6,774 TL  
 Renk :



Ürün Kodu : 016 038 250036  
 Ürün Adı : TAVAN GLOP ARMATÜRÜ  
 (BÜYÜK) 75W  
 Ambalaj Ad. : 24  
 Fiyat : 6,085 TL  
 Renk :



Ürün Kodu : 001 038 160101 00 00  
 Ürün Adı : YONCA TAVAN ARMATÜRÜ  
 Ambalaj Ad. : 16  
 Fiyat : 7,034 TL  
 Renk :



Ürün Kodu : 016 038 250043  
 Ürün Adı : TAVAN GLOP ARMATÜR  
 (BÜYÜK MEGA)75W  
 Ambalaj Ad. : 24  
 Fiyat : 7,097 TL  
 Renk :



Ürün Kodu : 016 038 250046  
 Ürün Adı : İNCİ TAVAN ARMATÜR(KROM)  
 Ambalaj Ad. : 48  
 Fiyat : 7,739 TL  
 Renk :



Ürün Kodu : 001 038 050101 00 00  
 Ürün Adı : YASEMİN UFO KÜRE TAVAN ARM.  
 Ambalaj Ad. : 12  
 Fiyat : 10,113 TL  
 Renk :



Ürün Kodu : 001 038 060101 00 00  
 Açıklama : YASEMİN KÜRE TAVAN ARM.  
 Ambalaj Ad. : 12  
 Fiyat : 8,741 TL  
 Renk :



Ürün Kodu : 001 038 070101 00 00  
 Ürün Adı : YASEMİN UFO DÜZ TAVAN ARM.  
 Ambalaj Ad. : 12  
 Fiyat : 9,908 TL  
 Renk :



Ürün Kodu : 001 038 030101 00 00  
 Açıklama : YASEMİN DÜZ TAVAN ARM.  
 Ambalaj Ad. : 12  
 Fiyat : 10,094 TL  
 Renk :



Ürün Kodu : 001 038 040101 00 00  
 Açıklama : YASEMİN UFO TAVAN ARM.  
 Ambalaj Ad. : 12  
 Fiyat : 10,740 TL  
 Renk :

Not: Renkli armatürlerde fiyat sorunuz.

## ARMATÜR ÇEŞİTLERİMİZ



Ürün Kodu : 016 038 250032  
 Ürün Adı : TAVAN GLOP ARMATÜRÜ  
 (MİDİ) 75W  
 Ambalaj Ad. : 24  
 Fiyat : 7,646 TL  
 Renk :



Ürün Kodu : 016 038 250033  
 Ürün Adı : TAVAN GLOP ARMATÜRÜ  
 (MAXİ) 75W  
 Ambalaj Ad. : 24  
 Fiyat : 8,272 TL  
 Renk :

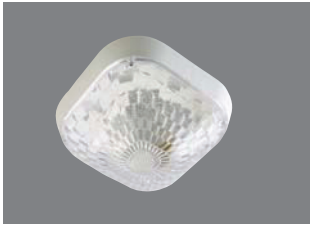

Ürün Kodu : 016 038 250014  
 Ürün Adı : KARE TAVAN GLOP ARM.  
 Ambalaj Ad. : 24  
 Fiyat : 5,929 TL  
 Renk :



Ürün Kodu : 001 038 020201 00 00  
 Açıklama : FULYA DUVAR APLİK  
 Ambalaj Ad. : 20  
 Fiyat : 7,212 TL  
 Renk :

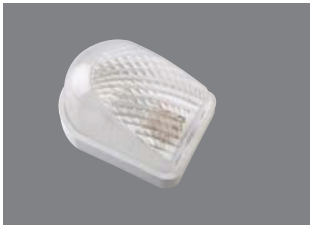

Ürün Kodu : 016 038 250013  
 Ürün Adı : DUVAR APLİK (KRALIÇE)  
 Ambalaj Ad. : 4 ad. / Koli: 48  
 Fiyat : 6,711 TL  
 Renk :



Ürün Kodu : 001 038 010201 00 00  
 Açıklama : MANOLYA DUVAR APLİK  
 Ambalaj Ad. : 20  
 Fiyat : 8,337 TL  
 Renk :



Ürün Kodu : 078 039 100005  
 Ürün Adı : NERGİS APLİK  
 Ambalaj Ad. : 8 ad. / Koli: 64  
 Fiyat : 6,958 TL  
 Renk :



Ürün Kodu : 001 038 090101 00 00  
 Ürün Adı : YASEMİN DUVAR APLİK  
 Ambalaj Ad. : 24  
 Fiyat : 8,887 TL  
 Renk :



Ürün Kodu : 016 038 250037  
 Ürün Adı : DUVAR APLİK (HİLAL)  
 Ambalaj Ad. : 4 ad. / Koli: 48  
 Fiyat : 4,527 TL  
 Renk :

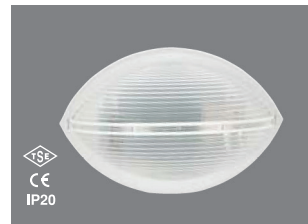

Ürün Kodu : 001 038 080101 00 00  
 Ürün Adı : YASEMİN OVAL ARMATÜR  
 Ambalaj Ad. : 24  
 Fiyat : 9,005 TL  
 Renk :



Ürün Kodu : 016 038 250038  
 Ürün Adı : DUVAR APLİK (YELPAZE)  
 Ambalaj Ad. : 4 ad. / Koli: 48  
 Fiyat : 6,555 TL  
 Renk :

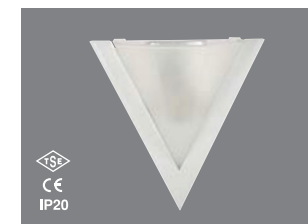

Ürün Kodu : 001 038 190201 00 00  
 Ürün Adı : PİRAMİT APLİK  
 Ambalaj Ad. : 24  
 Fiyat : 9,427 TL  
 Renk :

Not: Renkli armatürlerde fiyat sorunuz.

## Parklar, Bahçeler ve Kır Düğünlerinde Kurulumu Kolay Seyyar Aydınlatma Seti

YENİ



KOD	AÇIKLAMA	LUMEN	GÜÇ	IŞIK SICAKLIĞI	AMBALAJ	FİYAT
010 093 100900	9W 5'Li Led Lamba Seti Dış Mekan (Su Geçirmez) (Park ve Bahçeler için Kurulumu Kolay Seyyar Aydınlatma Seti)	750 lm	9W	3000K	1 Takım	99,40 USD.



KOD	AÇIKLAMA	LUMEN	GÜÇ	IŞIK SICAKLIĞI	AMBALAJ	FİYAT
010 093 100700	7W 5'Li Led Lamba Seti İç Mekan (Kapalı Mekanlar için Kurulumu Kolay Aydınlatma Seti)	560 lm	7W	3000K	1 Takım	85,40 USD.

7W 9W



## AKSESUARLAR

010 093 100701	9W Led + Ara Kablo 25cm + Erkek Konnektör Takımı	750 lm	9W	3000K	1ad.	19,680 USD.
010 093 100901	7W Led + Ara Kablo 25cm + Erkek Konnektör Takımı	560 lm	7W	3000K	1ad.	14,060 USD.
010 093 100000	1 Metre Ara Kablo İki Tarafı Konnektör Takılı				1ad.	2,820 USD.
010 093 100001	T Bağlantı Adaptörü				1ad.	5,630 USD.

## ARMATÜR ÇEŞİTLERİMİZ



Ürün Kodu : 001 038 250018 00 00  
 Ürün Adı : HAZIR ASKI TİJ TAKIMI  
 Ambalaj Ad. : 25 ad. / Koli: 500  
 Fiyat : 1,298 TL

Renk : 

Ürün Kodu : 001 038 250016 00 00  
 Ürün Adı : PAPATYA ASKI TİJ TAKIMI  
 Ambalaj Ad. : 25 ad. / Koli: 275  
 Fiyat : 1,404 TL

Renk : 

Ürün Kodu : 001 038 250017 00 00  
 Ürün Adı : BÜYÜK PAPATYA ASKI  
 TİJ TAKIMI  
 Ambalaj Ad. : 10 ad. / Koli: 80  
 Fiyat : 2,473 TL

Renk : 

Ürün Kodu : 016 038 250047  
 Ürün Adı : ÇİFT DUYLU METALİZE ARMATÜR  
 Ambalaj Ad. : 10  
 Fiyat : 19,637 TL

Renk : 

Ürün Kodu : 016 038 250025  
 Ürün Adı : 32 W SİMİT ARMATÜR  
 (ELK.BALANSTLI)  
 Ambalaj Ad. : 10  
 Fiyat : 24,190 TL

Renk : 

Ürün Kodu : 024 038 250019  
 Ürün Adı : SARKIT ARMATÜR POLYKARBONAT  
 PORS.DUYLU.BEŞ.RENK  
 Ambalaj Ad. : 5  
 Fiyat : 8,270 TL

## ARMATÜR ÇEŞİTLERİMİZ



Ürün Kodu : 001 038 010101 00 00  
Açıklama : MANOLYA TAVAN ARM.  
Ambalaj Ad. : 5  
Fiyat : 11,012 TL

Renk :



Ürün Kodu : 001 038 180101 00 00  
Ürün Adı : AKASYA TAVAN ARMATÜRÜ  
Ambalaj Ad. : 5  
Fiyat : 12,139 TL

Renk :



Ürün Kodu : 001 038 110101 00 00  
Ürün Adı : MERVE TAVAN ARMATÜRÜ  
Ambalaj Ad. : 5  
Fiyat : 12,976 TL

Renk :

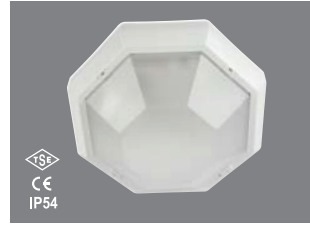

Ürün Kodu : 001 038 170101 00 00  
Ürün Adı : KAMELYA TAVAN ARMATÜRÜ  
Ambalaj Ad. : 10  
Fiyat : 16,112 TL

Renk :

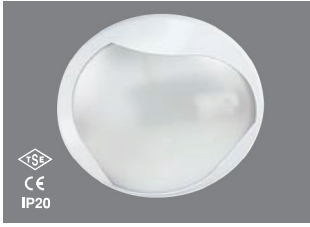

Ürün Kodu : 001 038 020101 00 00  
Ürün Adı : FULYA TAVAN ARMATÜRÜ  
Ambalaj Ad. : 5  
Fiyat : 12,317 TL

Renk :

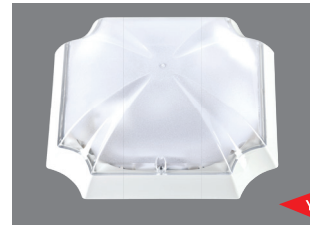

Ürün Kodu : 078 039 100006  
Ürün Adı : ÇİFT DUYULU TAVAN ARMATÜR  
Ambalaj Ad. : 2  
Fiyat : 13,915 TL

Renk :

YENİ



Ürün Kodu	Açıklama / Stok Cinsi	Ambalaj (Kutulu)	Ambalaj Birimi	TL
<b>T-5 LEDLİ ARMATÜRLER</b>				
102 038 518012	CLAT 5-18 W (12 V)	1	ad.	37,950
102 038 518220	CLAT 5-18 W (220 V)	1	ad.	43,572
102 038 513012	CLAT 5-13 W (12 V)	1	ad.	28,111
102 038 513220	CLAT 5-13 W (220 V)	1	ad.	32,327
102 038 510812	CLAT 5-8 W (12 V)	1	ad.	26,705
102 038 508220	CLAT 5-8 W (220 V)	1	ad.	29,516
102 038 506012	CLAT 5-6 W (12 V)	1	ad.	19,361
102 038 506220	CLAT 5-6 W (220 V)	1	ad.	24,046
102 038 504012	CLAT 5-4 W (12 V)	1	ad.	17,175
102 038 504220	CLAT 5-4 W (220 V)	1	ad.	21,860



<b>MUTLUSAN İTHAL ÜRÜNLERİMİZ</b>				
888 038 000328	L 328 LEDLİ KLASİK GECE LAMBASI AC 230V	10	ad.	4,043 USD.
888 038 000368	L 368 LEDLİ ÇOCUK GECE LAMBASI AC230V	10	ad.	4,043 USD.
888 038 000378	L 378 LEDLİ KELEBEK GECE LAMBASI AC230V	10	ad.	3,985 USD.
888 038 000388	L 388 LEDLİ ÇİÇEK GECE LAMBASI AC230V	10	ad.	3,985 USD.



## ARMATÜR ÇEŞİTLERİMİZ



YENİ

Ürün Kodu	: 016 038 270001
Ürün Adı	: Ledli Oval Kafesli Armatür
Kutu Miktarı	: 20
Fiyatı	: 29,020 TL



Ürün Kodu	: 016 038 250028
Ürün Adı	: Oval Düz Armatür
Kutu Miktarı	: 48
Fiyatı	: 7,631 TL



Max: 60W



Ürün Kodu	: 016 038 250029
Ürün Adı	: Oval Kafesli Armatür
Kutu Miktarı	: 48
Fiyatı	: 7,947 TL



Ürün Kodu	: 016 038 250030
Ürün Adı	: Oval Şapkalı Armatür
Kutu Miktarı	: 48
Fiyatı	: 8,267 TL



Max: 60W



Ürün Kodu	: 016 038 250040
Ürün Adı	: Nemliyer Oval Kafesli Armatür
Kutu Miktarı	: 48
Fiyatı	: 8,584 TL



Ürün Kodu	: 016 038 250039
Ürün Adı	: Nemliyer Oval Düz Armatür
Kutu Miktarı	: 48
Fiyatı	: 8,272 TL



Max: 60W



Ürün Kodu	: 016 038 250049
Ürün Adı	: Oval Kafesli Arm.(Siyah)
Kutu Miktarı	: 48
Fiyatı	: 7,947 TL



Ürün Kodu	: 016 038 250041
Ürün Adı	: Nemliyer Oval Şapkalı Arm.
Kutu Miktarı	: 48
Fiyatı	: 8,740 TL



Max: 60W

## ARMATÜR ÇEŞİTLERİMİZ



Ürün Kodu	: 016 038 130101 00 00
Ürün Adı	: Begonya Nemliyer Tavan Armatürü (Dikey)
Kutu Miktarı	: 12
Fiyatı	: 10,927 TL



Ürün Kodu	: 016 038 501018
Ürün Adı	: Polikarbon Gövde Kafesli Oval Armatür IP40 (Cam)
Kutu Miktarı	: 2
Fiyatı	: 20,778 TL



Ürün Kodu	: 016 038 140101 00 00
Ürün Adı	: Begonya Nemliyer Tavan Armatürü (Yatay)
Kutu Miktarı	: 12
Fiyatı	: 10,927 TL



Ürün Kodu	: 016 038 500017
Ürün Adı	: Polikarbon Gövde Kafesiz Oval Armatür IP40 (Cam)
Kutu Miktarı	: 2
Fiyatı	: 18,333 TL



Ürün Kodu	: 016 038 150101 00 00
Ürün Adı	: Begonya Nemliyer Tavan Armatürü (Klasik)
Kutu Miktarı	: 48
Fiyatı	: 10,927 TL



Ürün Kodu	: 016 038 502018
Ürün Adı	: Polikarbon Gövde Tel Kafesli Oval Armatür IP40 (Cam)
Kutu Miktarı	: 2
Fiyatı	: 31,777 TL

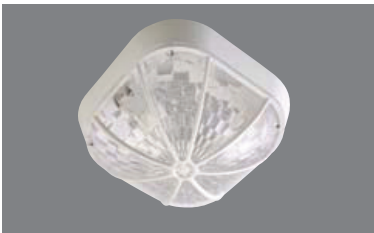

Ürün Kodu	: 016 038 250015
Ürün Adı	: Kare Tavan Glop Armatür (Kafesli)
Kutu Miktarı	: 24
Fiyatı	: 6,867 TL



Ürün Kodu	: 016 038 250034
Ürün Adı	: Tavan Glop Armatür (Maxi Kafesli) 75W
Kutu Miktarı	: 24
Fiyatı	: 9,363 TL





## NEMLİYER ARMATÜR ÇEŞİTLERİMİZ

TRUKAY  
Discover the potential

YENİ



Ürün Kodu : 016 038 700500  
Ürün Adı : Nemliyer Alüminyum Kafesli  
Cam Armatür Beyaz  
Kutu Miktarı : 1 / Koli: 20  
Fiyatı : 27,90 TL



Ürün Kodu : 016 038 700511  
Ürün Adı : Nemliyer Alüminyum Kafesli  
Cam Armatür Siyah  
Kutu Miktarı : 1 / Koli: 20  
Fiyatı : 27,90 TL



Ürün Kodu : 016 038 411100  
Ürün Adı : Aqua Kafesli Aplik Beyaz  
Kutu Miktarı : 1 / Koli: 20  
Fiyatı : 9,45 TL

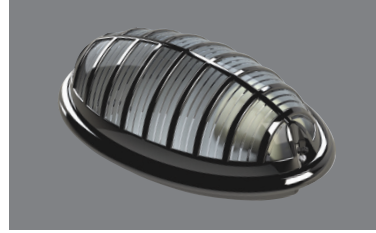

Ürün Kodu : 016 038 411111  
Ürün Adı : Aqua Kafesli Aplik Siyah  
Kutu Miktarı : 1 / Koli: 20  
Fiyatı : 9,45 TL



Ürün Kodu : 016 038 411300  
Ürün Adı : Opak Kafesli Armatür Beyaz  
Kutu Miktarı : 1 / Koli: 24  
Fiyatı : 9,45 TL

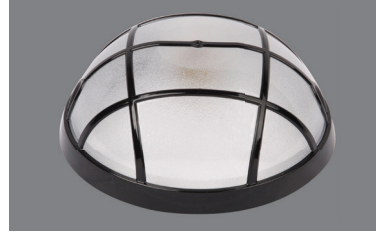

Ürün Kodu : 016 038 411311  
Ürün Adı : Opak Kafesli Armatür Siyah  
Kutu Miktarı : 1 / Koli: 24  
Fiyatı : 9,45 TL



Ürün Kodu : 016 038 410600  
Ürün Adı : Elips Opal Armatür Beyaz  
Kutu Miktarı : 1 / Koli: 10  
Fiyatı : 19,82 TL



Ürün Kodu : 016 038 410611  
Ürün Adı : Elips Opal Armatür Siyah  
Kutu Miktarı : 1 / Koli: 10  
Fiyatı : 19,82 TL

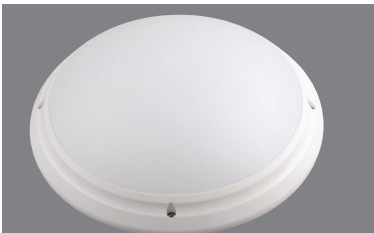

Ürün Kodu : 016 038 410500  
Ürün Adı : Opal Armatür  
Kutu Miktarı : 1 / Koli: 10  
Fiyatı : 19,82 TL



Ürün Kodu : 016 038 410511  
Ürün Adı : Opal Armatür  
Kutu Miktarı : 1 / Koli: 10  
Fiyatı : 19,82 TL

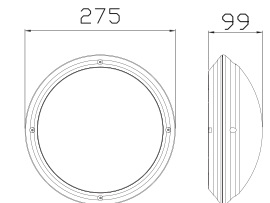
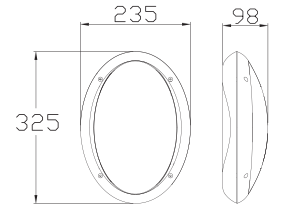
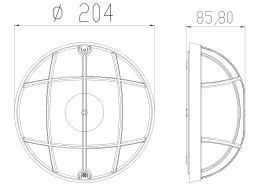
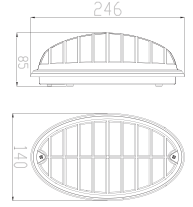

## AYDINLATMA

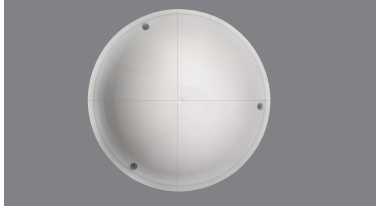

Ürün Kodu : 016 038 700100  
 Ürün Adı : Dolunay Opak Armatür Beyaz  
 Kutu Miktarı : 1 / Koli: 10  
 Fiyatı : 12,80 TL

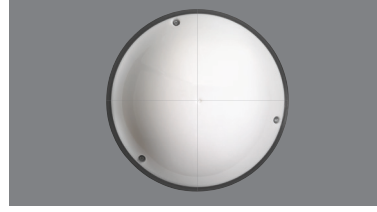

Ürün Kodu : 016 038 700111  
 Ürün Adı : Dolunay Opak Armatür Siyah  
 Kutu Miktarı : 1 / Koli: 10  
 Fiyatı : 12,80 TL

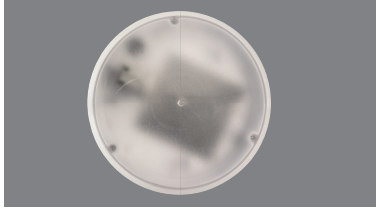
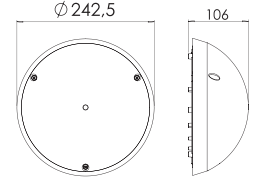

Ürün Kodu : 016 038 700200  
 Ürün Adı : Dolunay Şeffaf Armatür Beyaz  
 Kutu Miktarı : 1 / Koli: 10  
 Fiyatı : 12,80 TL

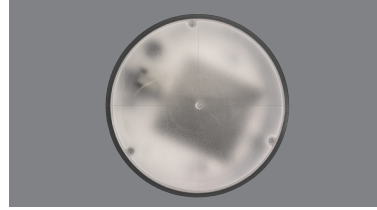

Ürün Kodu : 016 038 700211  
 Ürün Adı : Dolunay Şeffaf Armatür Siyah  
 Kutu Miktarı : 1 / Koli: 10  
 Fiyatı : 12,80 TL

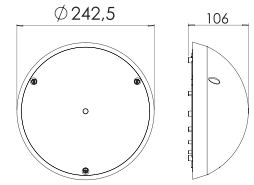

Ürün Kodu : 016 038 700300  
 Ürün Adı : Dolunay Opak Aplik Beyaz  
 Kutu Miktarı : 1 / Koli: 20  
 Fiyatı : 12,80 TL



Ürün Kodu : 016 038 700311  
 Ürün Adı : Dolunay Opak Aplik Siyah  
 Kutu Miktarı : 1 / Koli: 20  
 Fiyatı : 12,80 TL

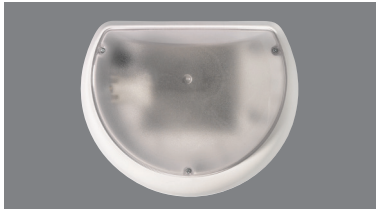
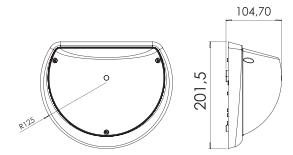

Ürün Kodu : 016 038 700400  
 Ürün Adı : Dolunay Şeffaf Aplik Beyaz  
 Kutu Miktarı : 1 / Koli: 20  
 Fiyatı : 12,80 TL

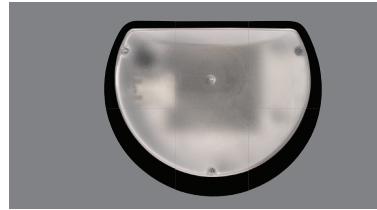

Ürün Kodu : 016 038 700411  
 Ürün Adı : Dolunay Şeffaf Aplik Siyah  
 Kutu Miktarı : 1 / Koli: 20  
 Fiyatı : 12,80 TL

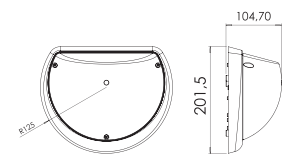

Ürün Kodu : 016 038 410800  
 Ürün Adı : Opak Armatür Beyaz  
 Kutu Miktarı : 1 / Koli: 16  
 Fiyatı : 11,81 TL



Ürün Kodu : 016 038 410811  
 Ürün Adı : Opak Armatür Siyah  
 Kutu Miktarı : 1 / Koli: 16  
 Fiyatı : 11,81 TL

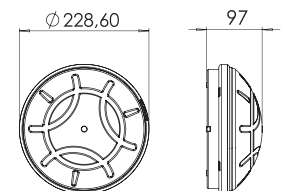

## AYDINLATMA



YENİ



Ürün Kodu	: 079 039 140003
Ürün Adı	: DEKORATİF CAM ARMATÜR BEYAZ ÇİFT DUYLU
Kutu Miktarı	: 12
Fiyatı	: 32,00 TL



Ürün Kodu	: 078 039 130002
Ürün Adı	: CAM ARMATÜR ÇİFT DUYLU BEYAZ
Kutu Miktarı	: 12
Fiyatı	: 21,786 TL



Ürün Kodu	: 079 039 140002
Ürün Adı	: DEKORATİF CAM ARMATÜR KROM ÇİFT DUYLU
Kutu Miktarı	: 12
Fiyatı	: 44,300 TL

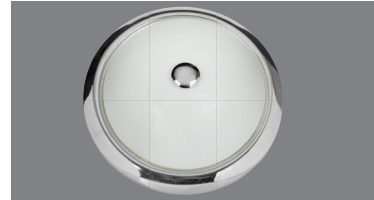

Ürün Kodu	: 078 039 130001
Ürün Adı	: CAM ARMATÜR KROM ÇİFT DUYLU
Kutu Miktarı	: 12
Fiyatı	: 28,814 TL



Ürün Kodu	: 079 039 140005
Ürün Adı	: CAM ARMATÜR GÜNEŞ ø30
Kutu Miktarı	: 12
Fiyatı	: 21,786 TL



Ürün Kodu	: 078 039 130130
Ürün Adı	: CAM ARMATÜR MARTI 30'LÜK
Kutu Miktarı	: 12
Fiyatı	: 21,786 TL



Ürün Kodu	: 079 039 140004
Ürün Adı	: CAM ARMATÜR GÜNEŞ ø25
Kutu Miktarı	: 20
Fiyatı	: 18,975 TL



Ürün Kodu	: 078 039 130125
Ürün Adı	: CAM ARMATÜR MARTI 25'LİK
Kutu Miktarı	: 12
Fiyatı	: 18,975 TL

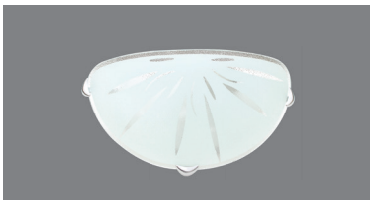

Ürün Kodu	: 079 039 140001
Ürün Adı	: YARIM AY CAM APLİK GÜNEŞ
Kutu Miktarı	: 20
Fiyatı	: 18,272 TL



Ürün Kodu	: 078 039 130200
Ürün Adı	: YARIMAY CAM APLİK MARTI
Kutu Miktarı	: 1 / Koli: 10
Fiyatı	: 18,272 TL





LED

ACİL AYDINLATMA ARMATÜRLERİ

<EXIT>

## EXIT- ŞEFFAF ACİL AYDINLATMA ARMATÜRLERİ (LEDLİ)



102 038 000801 CEXA-8-01 60,438 TL	102 038 000802 CEXA-8-02 60,438 TL	102 038 000803 CEXA-8-03 60,438 TL	102 038 000804 CEXA-8-04 60,438 TL	102 038 000805 CEXA-8-05 60,438 TL	102 038 000806 CEXA-8-06 60,438 TL	102 038 000807 CEXA-8-07 60,438 TL
102 038 000808 CEXA-8-08 60,438 TL	102 038 000809 CEXA-8-09 60,438 TL	102 038 000810 CEXA-8-10 60,438 TL	102 038 000811 CEXA-8-11 60,438 TL	102 038 000812 CEXA-8-12 60,438 TL	102 038 000813 CEXA-8-13 60,438 TL	102 038 000814 CEXA-8-14 60,438 TL
102 038 000815 CEXA-8-15 60,438 TL	102 038 000816 CEXA-8-16 60,438 TL	102 038 000817 CEXA-8-17 60,438 TL	102 038 000818 CEXA-8-18 60,438 TL	102 038 000819 CEXA-8-19 60,438 TL	102 038 000820 CEXA-8-20 60,438 TL	102 038 000821 CEXA-8-21 60,438 TL
102 038 000822 CEXA-8-22 60,438 TL	102 038 000823 CEXA-8-23 60,438 TL	102 038 000824 CEXA-8-24 60,438 TL	102 038 000825 CEXA-8-25 60,438 TL	102 038 000826 CEXA-8-26 60,438 TL	102 038 000827 CEXA-8-27 60,438 TL	

## LEDLİ ACİL AYDINLATMA ARMATÜRLERİ

YENİ



17,34,51 led seçenekleri ile  
Acilde veya sürekli çalışma  
1 veya 3 saat yanma süresi  
NI-CD Uzun ömürlü batarya  
Dekoratif ABS gövde  
Tavana sıva altı uygulama  
Ultra parlak ledler  
Aşırı şarj ve deşarj karşı koruma  
Şarj olma süresi 24 saat  
Besleme / Şarj / Hata gösterge ledleri  
Dahili test butonu  
Düşük bakım maliyeti

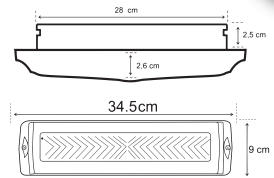
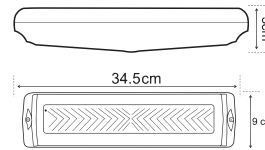

Turkey  
Discover the potential

Ürün Kodu	Açıklama / Stok Cinsi	Ambalaj (Kutulu)	TL
112 039 011717	17 Ledli S/Ü Acil Aydınlatma Armatürü	1 ad.	119,471
112 039 013434	34 Ledli S/Ü Acil Aydınlatma Armatürü	1 ad.	129,310
112 039 015151	51 Ledli S/Ü Acil Aydınlatma Armatürü	1 ad.	143,365
112 039 121717	17 Ledli S/A Acil Aydınlatma Armatürü	1 ad.	127,904
112 039 123434	34 Ledli S/A Acil Aydınlatma Armatürü	1 ad.	137,743
112 039 125151	51 Ledli S/A Acil Aydınlatma Armatürü	1 ad.	151,798

**YENİ ÇİFT YÜZLÜ YÖN TAVAN SERİSİ LEDLİ ACİL DURUM ARMATÜRLERİ****ÇİFT YÜZLÜ YÖN TAVAN SERİSİ LEDLİ ACİL DURUM ARMATÜRLERİ**

Dekoratif ABS gövde  
Acilde veya sürekli çalışma  
1 veya 3 saat yanma süresi  
NI- CD Uzun ömürlü batarya  
Pleksiglas üzeri gravür veya UV uygulama  
Adetli alımlarda farklı renk seçenekleri  
Ultra parlak ledler  
Aşırı şarj ve deşarja karşı koruma  
Şarj olma süresi 24 saat

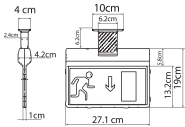

112 038 1000-XX  
73,060 TL

**ÇİFT YÜZLÜ YÖN DUVAR SERİSİ LEDLİ ACİL DURUM ARMATÜRLERİ**

Dekoratif ABS gövde  
Acilde veya sürekli çalışma  
1 veya 3 saat yanma süresi  
NI- CD Uzun ömürlü batarya  
Pleksiglas üzeri gravür veya UV uygulama  
Adetli alımlarda farklı renk seçenekleri  
Ultra parlak ledler  
Aşırı şarj ve deşarja karşı koruma  
Şarj olma süresi 24 saat

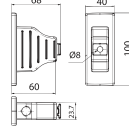

112 038 2000-XX  
75,506 TL

**ÇİFT YÜZLÜ (ALÜMİNYUM) İŞARET SERİSİ LEDLİ ACİL DURUM ARMATÜRLERİ**

Dekoratif alüminyum eloksal gövde  
Acilde veya sürekli çalışma  
1 veya 3 saat yanma süresi  
NI-CD Uzun ömürlü batarya  
Pleksiglas üzeri gravür uygulama  
Ultra parlak ledler  
Aşırı şarj ve deşarja karşı koruma  
Şarj olma süresi 24 saat

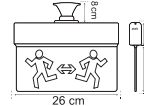

112 038 3000-XX  
105,799 TL

**BİLGİ SERİSİ LEDLİ ACİL DURUM ARMATÜRLERİ**

Acilde 1 veya 3 saat seçeneği  
NI-CD Uzun ömürlü batarya  
Sürekli veya acilde yanma imkanı  
340x90x48 mm ölçülerinde  
Akrilik üzeri folyo veya UV boyama  
Şarj olma süresi 24 Saat



112 038 4000-XX  
67,182 TL

**ÇİFT YÜZLÜ SIVA ÜSTÜ SERİSİ LEDLİ ACİL DURUM ARMATÜRLERİ**

Kombine bir modeldir,  
Hem aydınlatma hem de yönlendirmeyi sağlar.  
Dekoratif ABS gövde  
Acilde veya sürekli çalışma  
1 veya 3 saat yanma süresi  
NI-CD Uzun ömürlü batarya  
Pleksiglas üzeri gravür uygulama  
Tavana siva üstü uygulama  
Ultra parlak ledler  
Aşırı şarj ve deşarja karşı koruma  
Şarj olma süresi 24 saat

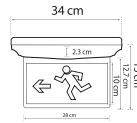

112 038 5000-XX  
178,007 TL

**ÇİFT YÜZLÜ SIVA ALTI SERİSİ LEDLİ ACİL DURUM ARMATÜRLERİ**

Kombine bir modeldir,  
Hem aydınlatma hem de yönlendirmeyi sağlar.  
Dekoratif ABS gövde  
Acilde veya sürekli çalışma  
1 veya 3 saat yanma süresi  
NI-CD Uzun ömürlü batarya  
Pleksiglas üzeri gravür uygulama  
Tavana siva altı uygulama  
Ultra parlak ledler  
Aşırı şarj ve deşarja karşı koruma  
Şarj olma süresi 24 saat



112 038 6000-XX  
184,737 TL

Sipariş Verdiğiniz Ürünün Sembol Kodunu Yazmayı Unutmayınız.

Ürün Kodunun Son 2 hanesi olan XX Rakamları Ürünün Sembol Kodunu belirtmektedir.

**SEMBOLE KOD TABLOSU**

01	ÇIKIŞ	02	EXIT	03		04		5		06	
07		08		09		10		11		12	
13		14		15		16	خروج	17	ÇIKIŞ EXIT	18	ВЫХОД

Standart sembol seçenekleri dışında istenilen sembol uygulanabilir.

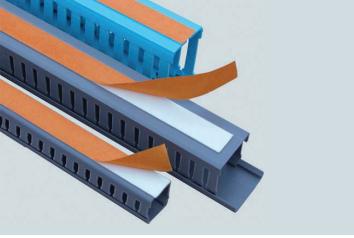
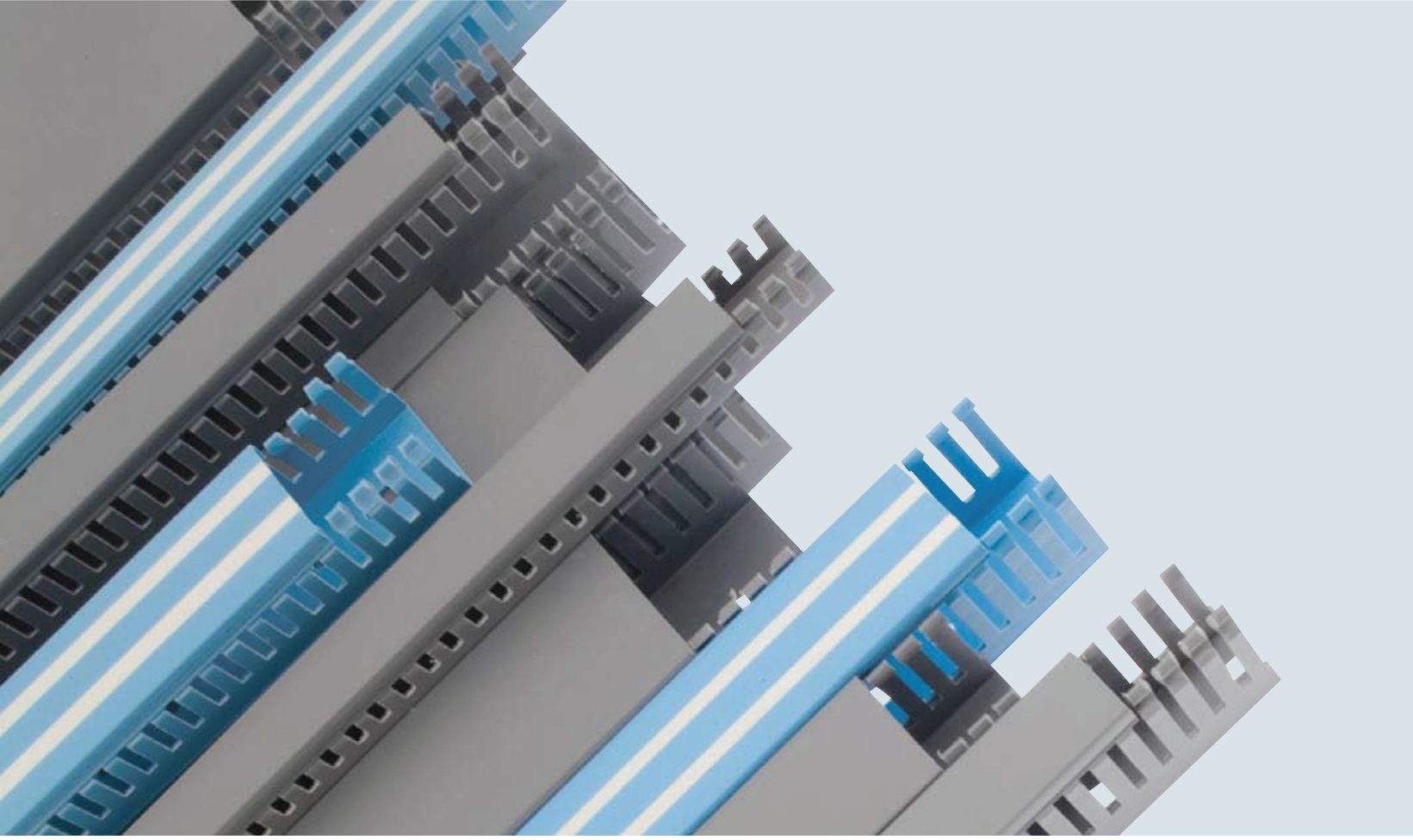

**KOLAY YAPIŞMAYI SAĞLAYAN,  
ÇİFT TARAFLI BANT KULLANILABİLİR**  
DOUBLE SIDED ADHESIVE TAPE ASSURING  
EASY FIXATION CAN BE USED

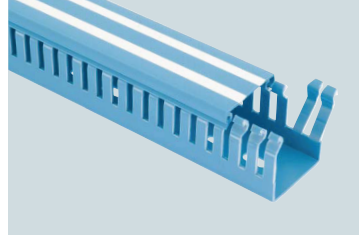

**KOLAY KIRILABİLEN KANAL ÇUBUKLARI**  
EASILY BREAKABLE TRUNKING SLOTS

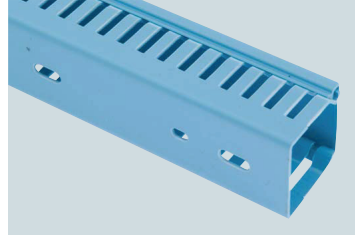

**DÜZENLİ ARALIKLARLA MONTAJ DELİKLERİ**  
ASSEMBLY HOLES WITH REGULAR INTERVALS

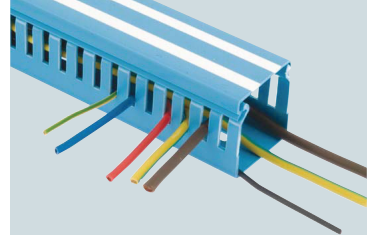

**YAZI YAZMAYI KOLAYLAŞTIRAN BEYAZ BANTLAR**  
EASY TO WRITE WHITE STRIPS

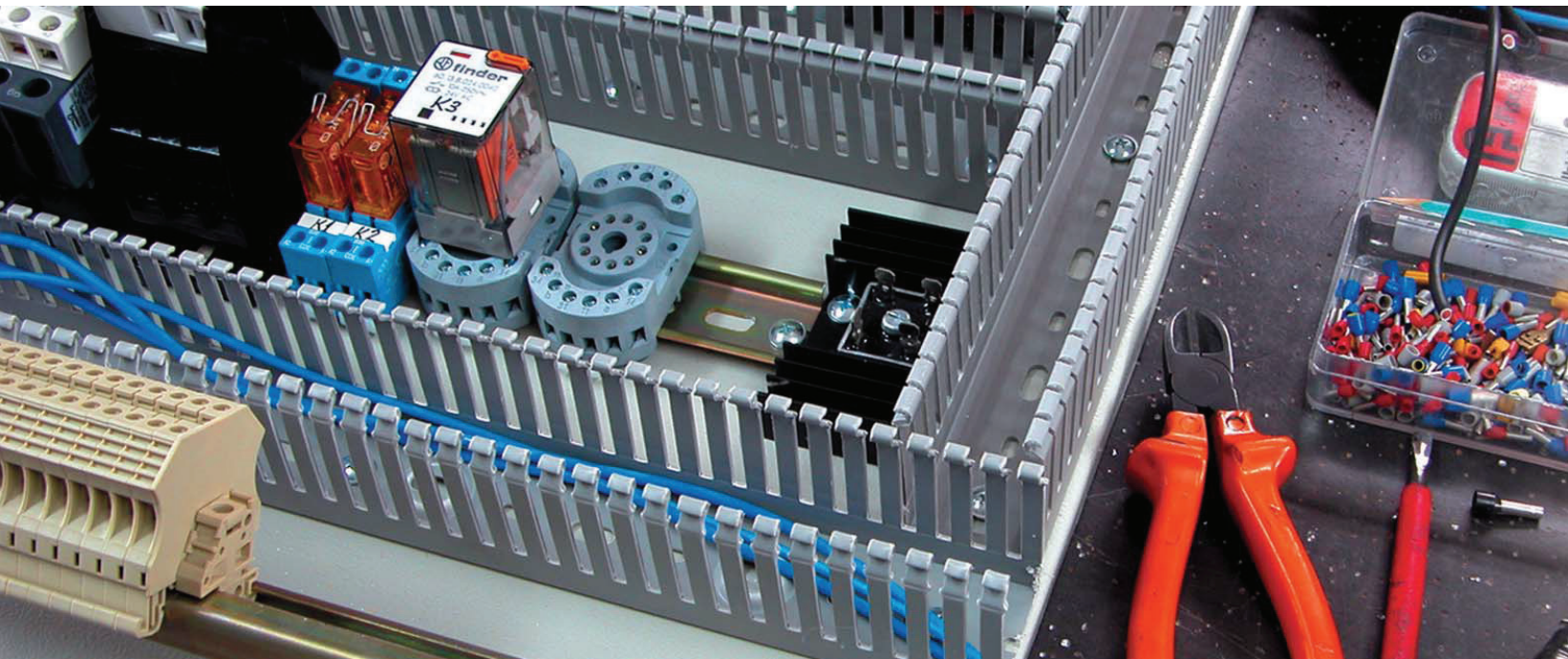

Ürün Kodu	Açıklama / Stok Cinsi	Ambalaj (Kutulu)	Ambalaj Birimi	TL
<b>PANO İÇİN SÜPER LÜX KANALLAR (GRİ)</b>				
001 005 025025 20 17	25X25 KABLO KAN.(DELİKLİ)(GRİ)	1mt. 64	2mt. 128	2,610
001 005 025040 20 17	25X40 KABLO KAN.(DELİKLİ)(GRİ)	1mt. 40	2mt. 80	4,043
001 005 025060 20 17	25X60 KABLO KAN.(DELİKLİ)(GRİ)	1mt. 36	2mt. 80	5,059
001 005 040040 20 17	40X40 KABLO KAN.(DELİKLİ)(GRİ)	1mt. 25	2mt. 50	4,678
001 005 040060 20 17	40X60 KABLO KAN.(DELİKLİ)(GRİ)	1mt. 24	2mt. 48	5,452
001 005 060040 20 17	60X40 KABLO KAN.(DELİKLİ)(GRİ)	1mt. 24	2mt. 48	5,452
001 005 060060 20 17	60X60 KABLO KAN.(DELİKLİ)(GRİ)	1mt. 16	2mt. 32	6,006
001 005 060080 20 17	60X80 KABLO KAN.(DELİKLİ)(GRİ)	1mt. 12	2mt. 24	7,854
001 005 060100 20 17	60X100 KABLO KAN.(DELİKLİ)(GRİ)	1mt. 8	2mt. 16	9,794
001 005 040080 20 17	40X80 KABLO KAN.(DELİKLİ)(GRİ)	1mt. 18	2mt. 36	6,930
001 005 080060 20 17	80X60 KABLO KAN.(DELİKLİ)(GRİ)	1mt. 12	2mt. 24	7,854
001 005 100060 20 17	100X60 KABLO KAN.(DELİKLİ)(GRİ)	1mt. 8	2mt. 16	9,794
001 005 100100 20 17	100X100 KABLO KAN.(DELİKLİ)(GRİ)	1mt. 4	2mt. 8	14,036

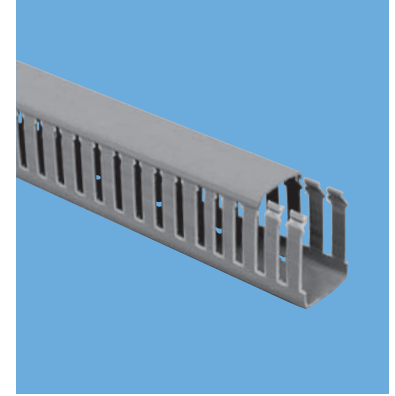

<b>PANO İÇİN SÜPER LÜX KANALLAR (GRİ) HALOGEN FREE</b>				
001 065 025025 20 17	25X25 KABLO KAN.(DELİKLİ )(H.FREE)(GRİ)	1mt. 64	2mt. 128	9,24
001 065 025040 20 17	25X40 KABLO KAN.(DELİKLİ)(H.FREE)(GRİ)	1mt. 40	2mt. 80	12,15
001 065 040040 20 17	40X40 KABLO KAN.(DELİKLİ)(H.FREE)(GRİ)	1mt. 25	2mt. 50	16,55
001 065 040060 20 17	40X60 KABLO KAN.(DELİKLİ)(H.FREE)(GRİ)	1mt. 24	2mt. 24	19,37

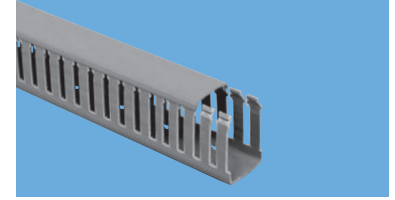

<b>PANO İÇİN SÜPER LÜX KANALLAR (MAVİ-BEYAZ ŞERİT)</b>				
001 005 025025 20 13	25X25 KABLO KAN.(DELİKLİ)(MAVİ)	1mt. 64	2mt. 128	2,657
001 005 025040 20 13	25X40 KABLO KAN.(DELİKLİ)(MAVİ)	1mt. 40	2mt. 80	4,158
001 005 025060 20 13	25X60 KABLO KAN.(DELİKLİ)(MAVİ)	1mt. 36	2mt. 80	5,128
001 005 040040 20 13	40X40 KABLO KAN.(DELİKLİ)(MAVİ)	1mt. 25	2mt. 50	4,759
001 005 040060 20 13	40X60 KABLO KAN.(DELİKLİ)(MAVİ)	1mt. 24	2mt. 48	5,602
001 005 060040 20 13	60X40 KABLO KAN.(DELİKLİ)(MAVİ)	1mt. 24	2mt. 48	5,602
001 005 060060 20 13	60X60 KABLO KAN.(DELİKLİ)(MAVİ)	1mt. 16	2mt. 32	6,757
001 005 060080 20 13	60X80 KABLO KAN.(DELİKLİ)(MAVİ)	1mt. 12	2mt. 24	7,970
001 005 060100 20 13	60X100 KABLO KAN.(DELİKLİ)(MAVİ)	1mt. 8	2mt. 16	10,395
001 005 040080 20 13	40X80 KABLO KAN.(DELİKLİ)(MAVİ)	1mt. 18	2mt. 36	7,046
001 005 080060 20 13	80X60 KABLO KAN.(DELİKLİ)(MAVİ)	1mt. 12	2mt. 24	7,970
001 005 100060 20 13	100X60 KABLO KAN.(DELİKLİ)(MAVİ)	1mt. 8	2mt. 16	10,395
001 005 100100 20 13	100X100 KABLO KAN.(DELİKLİ)(MAVİ)	1mt. 4	2mt. 8	14,021



<b>YAPIŞKAN BANTLI DELİKLİ KANALLAR (MAVİ-BEYAZ ŞERİT)</b>				
001 008 025025 20 13	25X25 MM DEL.KANAL YPŞK.BANTLI (MAVİ)	1mt. 64	2mt. 128	3,003
001 008 025040 20 13	25X40 MM DEL.KANAL YPŞK.BANTLI (MAVİ)	1mt. 40	2mt. 80	4,505
001 008 025060 20 13	25X60 MM DEL.KANAL YPŞK.BANTLI (MAVİ)	1mt. 36	2mt. 80	5,510
001 008 040040 20 13	40X40 MM DEL.KANAL YPŞK.BANTLI (MAVİ)	1mt. 25	2mt. 50	5,544
001 008 040060 20 13	40X60 MM DEL.KANAL YPŞK.BANTLI (MAVİ)	1mt. 24	2mt. 48	6,445
001 008 060040 20 13	60X40 MM DEL.KANAL YPŞK.BANTLI (MAVİ)	1mt. 24	2mt. 48	7,438
001 008 060060 20 13	60X60 MM DEL.KANAL YPŞK.BANTLI (MAVİ)	1mt. 16	2mt. 32	7,739
001 008 060080 20 13	60X80 MM DEL.KANAL YPŞK.BANTLI (MAVİ)	1mt. 12	2mt. 24	11,435
001 008 060100 20 13	60X100 MM DEL.KANAL YPŞK.BANTLI (MAVİ)	1mt. 8	2mt. 16	12,214
001 008 040080 20 13	40X80 MM DEL.KANAL YPŞK.BANTLI (MAVİ)	1mt. 18	2mt. 36	7,854
001 008 080060 20 13	80X60 MM DEL.KANAL YPŞK.BANTLI (MAVİ)	1mt. 12	2mt. 24	11,435
001 008 100060 20 13	100X60 MM DEL.KANAL YPŞK.BANTLI (MAVİ)	1mt. 8	2mt. 16	12,214
001 008 100100 20 13	100X100 MM DEL.KANAL YPŞK.BANTLI (MAVİ)	1mt. 4	2mt. 8	15,400

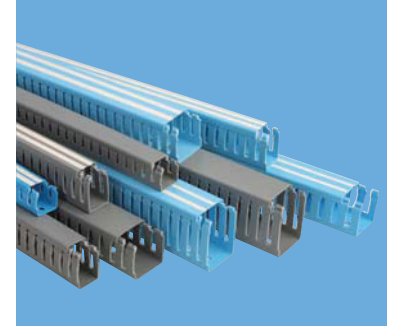

<b>YAPIŞKAN BANTLI DELİKLİ KANALLAR (GRİ)</b>				
001 008 025025 20 17	25*25 MM DEL.KANAL YPŞK.BANTLI (GRİ)	1mt. 64	2mt. 128	2,946
001 008 025040 20 17	25*40 MM DEL.KANAL YPŞK.BANTLI (GRİ)	1mt. 40	2mt. 80	4,389
001 008 025060 20 17	25*60 MM DEL.KANAL YPŞK.BANTLI (GRİ)	1mt. 36	2mt. 80	5,313
001 008 040040 20 17	40*40 MM DEL.KANAL YPŞK.BANTLI (GRİ)	1mt. 25	2mt. 50	5,487
001 008 040060 20 17	40*60 MM DEL.KANAL YPŞK.BANTLI (GRİ)	1mt. 24	2mt. 48	6,237
001 008 060040 20 17	60*40 MM DEL.KANAL YPŞK.BANTLI (GRİ)	1mt. 24	2mt. 48	6,815
001 008 060060 20 17	60*60 MM DEL.KANAL YPŞK.BANTLI (GRİ)	1mt. 16	2mt. 32	7,277
001 008 060080 20 17	60*80 MM DEL.KANAL YPŞK.BANTLI (GRİ)	1mt. 12	2mt. 24	8,605
001 008 060100 20 17	60*100 MM DEL.KANAL YPŞK.BANTLI (GRİ)	1mt. 8	2mt. 16	11,204
001 008 040080 20 17	40*80 MM DEL.KANAL YPŞK.BANTLI (GRİ)	1mt. 18	2mt. 36	7,623
001 008 080060 20 17	80*60 MM DEL.KANAL YPŞK.BANTLI (GRİ)	1mt. 12	2mt. 24	8,605
001 008 100060 20 17	100*60 MM DEL.KANAL YPŞK.BANTLI (GRİ)	1mt. 8	2mt. 16	11,204
001 008 100100 20 17	100*100 MM DEL.KANAL YPŞK.BANTLI (GRİ)	1mt. 4	2mt. 8	14,850

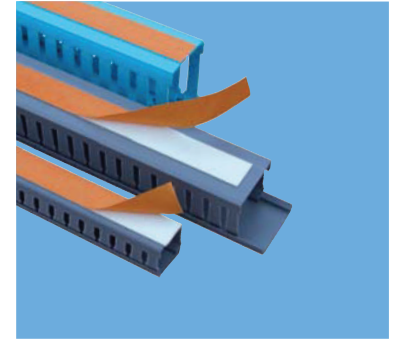

<b>HAREKETLİ KABLO KANALLARI</b>				
888 140 001515	15x15 MM HAREKETLİ KABLO KANALI		1mt.	26,334 EUR
888 140 001825	18x25 MM HAREKETLİ KABLO KANALI		1mt.	26,334 EUR
888 140 002025	20x25 MM HAREKETLİ KABLO KANALI		1mt.	35,574 EUR
888 140 002040	20x40 MM HAREKETLİ KABLO KANALI		1mt.	37,191 EUR
888 140 002050	20x50 MM HAREKETLİ KABLO KANALI		1mt.	40,194 EUR
888 140 002540	25x40 MM HAREKETLİ KABLO KANALI		1mt.	40,194 EUR
888 140 003040	30x40 MM HAREKETLİ KABLO KANALI		1mt.	46,431 EUR
888 140 003041	MONTAJ AYAKLARI (1 TAKIM)		1mt.	6,214 EUR

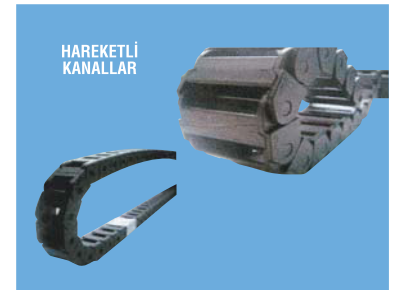



Ürün Kodu	Açıklama / Stok Cinsi	Ambalaj (Kutulu)	Ambalaj Birimi	Fiyat
<b>RAY KLEMENSLER (VİDALI)</b>				
010 094 000025	2,5 MM RAY KLEMENSİ	100	ad.	1,362
010 094 000004	4 MM RAY KLEMENSİ	100	ad.	1,403
010 094 000006	6 MM RAY KLEMENSİ	100	ad.	1,763
010 094 000010	10 MM RAY KLEMENSİ	100	ad.	2,288
010 094 000016	16 MM RAY KLEMENSİ	30	ad.	3,767
010 094 000035	35 MM RAY KLEMENSİ	20	ad.	6,184
010 094 010001	KLEMENS DURDURUCU	100	ad.	1,004

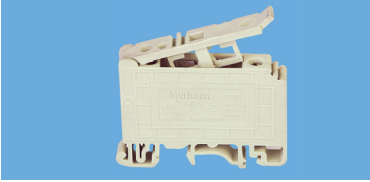

<b>RAY KLEMENSLER (SİGORTALI)</b>				
010 094 000051	SİGORTALI RAY KLEMENS	100	ad.	4,764

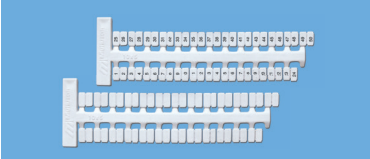

<b>DEKAFİX</b>				
010 094 010006	YAZILI DEKAFİX (1 ADET FİYATI)	500	ad.	0,066
010 094 010007	YAZISIZ DEKAFİX (1 ADET FİYATI)	100	ad.	0,050

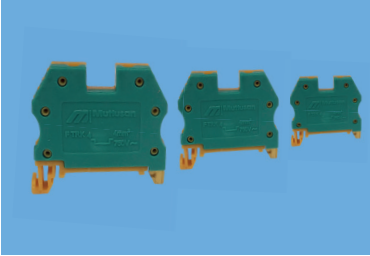

<b>RAY KLEMENSLER (TOPRAKLAMALI)</b>				
010 094 010003	2,5 MM TOPRAKLAMALI RAY KLEMENSİ	100	ad.	4,764
010 094 010008	4 MM TOPRAKLAMALI RAY KLEMENSİ	100	ad.	4,764
010 094 010004	6 MM TOPRAKLAMALI RAY KLEMENSİ	100	ad.	6,064
010 094 010009	10 MM TOPRAKLAMALI RAY KLEMENSİ	100	ad.	6,064
010 094 010005	16 MM TOPRAKLAMALI RAY KLEMENSİ	30	ad.	8,663
010 094 010010	35 MM TOPRAKLAMALI RAY KLEMENSİ	20	ad.	9,333

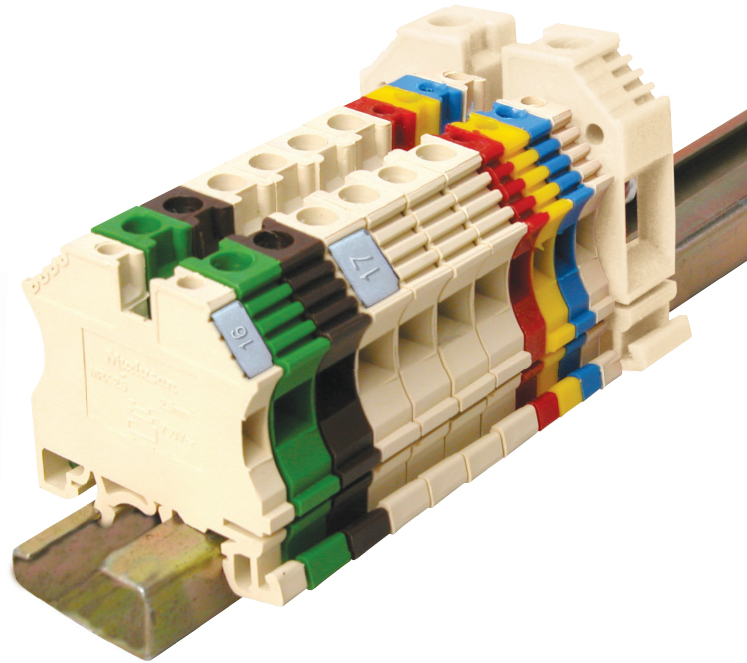
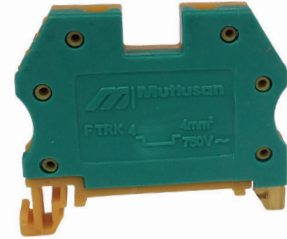
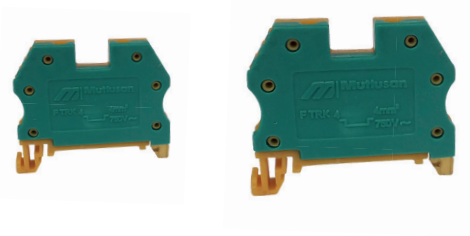

Ürün Kodu	Açıklama / Stok Cinsi	Ambalaj (Kutu/Bağ)	Ambalaj (Koli/Çuval)	TL
<b>RAYLAR-TOPRAKLAMA ÇUBUKLARI VE BARALAR</b>				
014 094 020001	RAY TAŞIYICISI (SAC)	75 ad.		1,361
001 025 020100 00 00	KLEMENS RAYI(1M)	25 mt.		6,340
001 025 000100 00 00	W OTOMAT RAYI(1M)	50 mt.		3,487
001 025 000033 00 00	W OTOMAT RAYI(33CM)	50 ad.		1,122
001 025 000099 99 00	W OTOMAT RAYI(ÖZEL BOY)	50 ad.		3,969
001 025 900100 00 00	W OTOMAT RAYI(DELİKLİ)(1M)	50 mt.		4,025
034 025 100001	TOPRAKLAMA BARASI MESNEDİ	50 ad.		0,787
034 025 040001	TOPRAKLAMA BARASI 1 M.	25 mt.		21,175
034 025 040004	TRIF. MÜŞTEREK BARA İĞNE UÇLU 53 CM	25 ad.		26,250
034 025 040006	TRIF. MÜŞTEREK BARA İĞNE UÇLU 106 CM	25 ad.		45,846
034 025 040002	MON.MÜŞTEREK BARA İĞNE UÇLU	25 ad.		18,900
<b>MİNİ BOY MESNET İZOLATÖRLERİ A.G. (1KV)</b>				
049 123 010001	BMI-M 5/2C MİNİ İZOLATÖR	250 ad.		0,837
049 123 010002	BMI-M 5/1C+1S MİNİ İZOLATÖR	250 ad.		1,184
049 123 010003	BMI-M 5/2S MİNİ İZOLATÖR	250 ad.		1,299
<b>ORTA BOY KONİK MESNET İZOLATÖRLERİ A.G. (1KV)</b>				
049 123 020001	BMI-M 6/2C ORTA KONİK İZOLATÖR	100 ad.		1,513
049 123 020002	BMI-M 6/1C+1S ORTA KONİK İZOLATÖR	100 ad.		1,819
049 123 020003	BMI-M 6/2S ORTA KONİK İZOLATÖR	100 ad.		1,964
<b>BÜYÜK BOY MESNET İZOLATÖRLERİ A.G. (1KV)</b>				
049 123 030001	BMI-M 8/2C BÜYÜK BOY FIÇI İZOLATÖR	40 ad.		2,208
049 123 030002	BMI-M 8/1C+1S BÜYÜK BOY FIÇI İZOLATÖR	40 ad.		2,723
049 123 030003	BMI-M 8/2S BÜYÜK BOY FIÇI İZOLATÖR	40 ad.		2,995
049 123 030004	BMI-M 10/2C BÜYÜK BOY FIÇI İZOLATÖR	40 ad.		2,692
049 123 030005	BMI-M 10/1C+1S BÜYÜK BOY FIÇI İZOLATÖR	40 ad.		2,965
049 123 030006	BMI-M 10/2S BÜYÜK BOY FIÇI İZOLATÖR	40 ad.		3,328
049 123 050001	BMS (M8-M10) BARA TUTUCU	50 ad.		2,801
<b>TARAK İZOLATÖRLER</b>				
049 123 040001	3X1 F TARAK İZOLATÖR (2'li TAKIM)	20 TAKIM		9,378
049 123 040002	3X2 F TARAK İZOLATÖR (2'li TAKIM)	20 TAKIM		10,890
049 123 040003	3X1 F+N TARAK İZOLATÖR (2'li TAKIM)	20 TAKIM		12,100
049 123 040005	3X2 F+N TARAK İZOLATÖR (2'li TAKIM)	4 TAKIM		15,004
<b>SACDAN DİLME SICAK DALDIRMA GALVANİZLİ TOP.ŞERİDİ</b>				
091 025 023030	KTS.001 30X3 MM 50 MT TOPRAKLAMA ŞERİDİ	1 mt.		5,775
091 025 023035	KTS.001 30X3,5 MM 50 MT TOPRAKLAMA ŞERİDİ	1 mt.		6,641
<b>SICAK DALDIRMA GALVANİZLİ TOPRAKLAMA ELEKTRODU</b>				
091 025 440401	KTE.004 40X40X4 MM 1 MT GALVANİZLİ KÖŞEBENT KAZIK	1 ad.		21,368
091 025 540401	KTE.005 40X40X4 MM 1,5 MT GALVANİZLİ KÖŞEBENT KAZIK	1 ad.		31,763
<b>SICAK DALDIRMA GALVANİZLİ BAĞLANTI KLEMENSİ</b>				
091 025 103003	KTK.001 30X3 MM ŞERİTTEN 30X3 MM ŞERİTE BAĞL.KLEMENSİ	1 ad.		3,609
091 025 103004	KTK.002 30X3,5 MM ŞERİTTEN 30X3,5 MM ŞERİTE BAĞL.KLEMENSİ	1 ad.		3,609
<b>BORU GEÇME TOPRAKLAMA ÇUBUĞU</b>				
091 025 010001	TOPRAKLAMA ÇUBUĞU 1 M. (PIYASA)	25 ad.		5,833
091 025 011610	TOP ÇUBUĞU BORU GEÇMELİ 16 MM 1 MT	10 ad.		38,981
091 025 011615	TOP ÇUBUĞU BORU GEÇMELİ 16 MM 1,5 MT	10 ad.		54,863
091 025 012010	TOP ÇUBUĞU BORU GEÇMELİ 20 MM 1 MT	10 ad.		62,081
091 025 012015	TOP ÇUBUĞU BORU GEÇMELİ 20 MM 1,5 MT	10 ad.		78,684

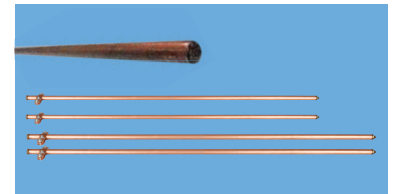
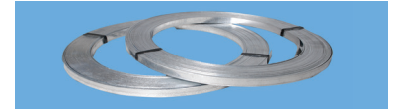
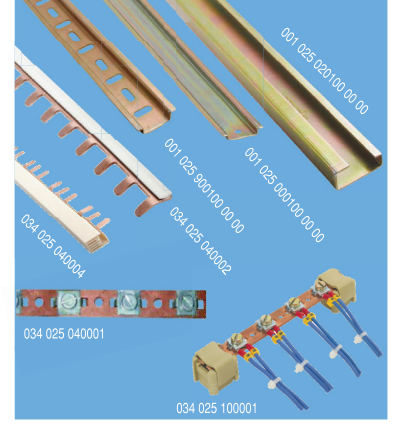
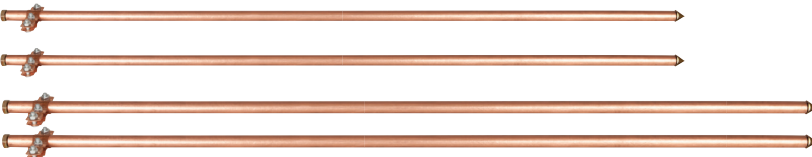



Ürün Kodu	Açıklama / Stok Cinsi	Ambalaj (Kutu/Bağ)	Ambalaj (Koli/Çuval)	TL
<b>SIKMALI TİP KABLO PAPUÇLARI (İTHAL)</b>				
123 037 000010	10 MM2 SIKMALI TİP KABLO PAPUCU (İTHAL) M5	800 ad.		0,325
123 037 000016	16 MM2 SIKMALI TİP KABLO PAPUCU (İTHAL) M6	500 ad.		0,410
123 037 000025	25 MM2 SIKMALI TİP KABLO PAPUCU (İTHAL) M8	350 ad.		0,752
123 037 000035	35 MM2 SIKMALI TİP KABLO PAPUCU (İTHAL) M8	200 ad.		1,094
123 037 000050	50 MM2 SIKMALI TİP KABLO PAPUCU (İTHAL) M10	150 ad.		1,367
123 037 000070	70 MM2 SIKMALI TİP KABLO PAPUCU (İTHAL) M10	100 ad.		2,222
123 037 000095	95 MM2 SIKMALI TİP KABLO PAPUCU (İTHAL) M12	70 ad.		2,803
123 037 000120	120 MM2 SIKMALI TİP KABLO PAPUCU(İTHAL) M12	50 ad.		3,760
123 037 000150	150 MM2 SIKMALI TİP KABLO PAPUCU(İTHAL) M12	40 ad.		6,495
123 037 000185	185 MM2 SIKMALI TİP KABLO PAPUCU(İTHAL) M16	30 ad.		7,691
123 037 000240	240 MM2 SIKMALI TİP KABLO PAPUCU(İTHAL) M16	24 ad.		11,451
123 037 000300	300 MM2 SIKMALI TİP KABLO PAPUCU(İTHAL) M16	20 ad.		14,698
<b>SIKMALI TİP KABLO PAPUÇLARI (STANDART SERİSİ)</b>				
123 037 500006	06 MM2 SIKMALI TİP KABLO PAPUCU (STANDART SERİSİ) M5	1000 ad.		0,336
123 037 500010	10 MM2 SIKMALI TİP KABLO PAPUCU (STANDART SERİSİ) M5	800 ad.		0,440
123 037 500016	16 MM2 SIKMALI TİP KABLO PAPUCU (STANDART SERİSİ) M6	500 ad.		0,659
123 037 500025	25 MM2 SIKMALI TİP KABLO PAPUCU (STANDART SERİSİ) M8	350 ad.		1,060
123 037 500035	35 MM2 SIKMALI TİP KABLO PAPUCU (STANDART SERİSİ) M8	200 ad.		1,436
123 037 500050	50 MM2 SIKMALI TİP KABLO PAPUCU (STANDART SERİSİ) M10	150 ad.		2,222
123 037 500070	70 MM2 SIKMALI TİP KABLO PAPUCU (STANDART SERİSİ) M10	100 ad.		3,179
123 037 500095	95 MM2 SIKMALI TİP KABLO PAPUCU (STANDART SERİSİ) M12	70 ad.		3,931
123 037 500120	120 MM2 SIKMALI TİP KABLO PAPUCU(STANDART SERİSİ) M12	50 ad.		5,640
123 037 500150	150 MM2 SIKMALI TİP KABLO PAPUCU(STANDART SERİSİ) M12	40 ad.		9,058
123 037 500185	185 MM2 SIKMALI TİP KABLO PAPUCU(STANDART SERİSİ) M16	30 ad.		11,109
123 037 500240	240 MM2 SIKMALI TİP KABLO PAPUCU(STANDART SERİSİ) M16	24 ad.		15,382
123 037 500300	300 MM2 SIKMALI TİP KABLO PAPUCU(STANDART SERİSİ) M16	20 ad.		18,800
<b>ÖZEL METRİK SIKMALI TİP KABLO PAPUÇLARI</b>				
123 037 700010	10 MM2 SIKMALI TİP KABLO PAPUCU (ÖZEL SERİSİ) M6	800 ad.		0,427
123 037 700016	16 MM2 SIKMALI TİP KABLO PAPUCU (ÖZEL SERİSİ) M8	500 ad.		0,641
123 037 700025	25 MM2 SIKMALI TİP KABLO PAPUCU (ÖZEL SERİSİ) M10	350 ad.		1,068
123 037 700035	35 MM2 SIKMALI TİP KABLO PAPUCU (ÖZEL SERİSİ) M10	200 ad.		1,406
123 037 700050	50 MM2 SIKMALI TİP KABLO PAPUCU (ÖZEL SERİSİ) M10	150 ad.		2,222
123 037 700070	70 MM2 SIKMALI TİP KABLO PAPUCU (ÖZEL SERİSİ) M12	100 ad.		3,179
123 037 700095	95 MM2 SIKMALI TİP KABLO PAPUCU (ÖZEL SERİSİ) M12	70 ad.		3,931
123 037 700120	120 MM2 SIKMALI TİP KABLO PAPUCU (ÖZEL SERİSİ) M12	50 ad.		5,640
123 037 700150	150 MM2 SIKMALI TİP KABLO PAPUCU (ÖZEL SERİSİ) M12	40 ad.		9,058
123 037 700185	185 MM2 SIKMALI TİP KABLO PAPUCU (ÖZEL SERİSİ) M16	30 ad.		11,109
123 037 700240	240 MM2 SIKMALI TİP KABLO PAPUCU (ÖZEL SERİSİ) M16	24 ad.		15,382
123 037 700300	300 MM2 SIKMALI TİP KABLO PAPUCU (ÖZEL SERİSİ) M16	20 ad.		18,800
<b>SIKMALI TİP KABLO PAPUÇLARI (ALÜMİNYUM SERİSİ)</b>				
123 037 400016	16 MM2 SIKMALI TİP KABLO PAPUCU (ALÜMİNYUM SERİSİ) M6	200 ad.		1,271
123 037 400025	25 MM2 SIKMALI TİP KABLO PAPUCU (ALÜMİNYUM SERİSİ) M8	125 ad.		1,525
123 037 400035	35 MM2 SIKMALI TİP KABLO PAPUCU (ALÜMİNYUM SERİSİ) M8	75 ad.		1,845
123 037 400050	50 MM2 SIKMALI TİP KABLO PAPUCU (ALÜMİNYUM SERİSİ) M10	60 ad.		2,733
123 037 400070	70 MM2 SIKMALI TİP KABLO PAPUCU (ALÜMİNYUM SERİSİ) M12	50 ad.		3,178
123 037 400095	95 MM2 SIKMALI TİP KABLO PAPUCU (ALÜMİNYUM SERİSİ) M12	40 ad.		3,813
123 037 400120	120 MM2 SIKMALI TİP KABLO PAPUCU(ALÜMİNYUM SERİSİ) M12	25 ad.		5,825
123 037 400150	150 MM2 SIKMALI TİP KABLO PAPUCU(ALÜMİNYUM SERİSİ) M12	20 ad.		8,147
123 037 400185	185 MM2 SIKMALI TİP KABLO PAPUCU(ALÜMİNYUM SERİSİ) M12	15 ad.		11,244
123 037 400240	240 MM2 SIKMALI TİP KABLO PAPUCU(ALÜMİNYUM SERİSİ) M12	10 ad.		13,567
123 037 400300	300 MM2 SIKMALI TİP KABLO PAPUCU(ALÜMİNYUM SERİSİ) M16	8 ad.		16,958
<b>STANDART TİP SIKMALI KABLO EK MUFLARI</b>				
123 037 300006	6 MM2 UZUN VE KALIN TİP SIKMALI EK MUFU	1000 ad.		0,323
123 037 300010	10 MM2 UZUN VE KALIN TİP SIKMALI EK MUFU	800 ad.		0,326
123 037 300016	16 MM2 UZUN VE KALIN TİP SIKMALI EK MUFU	500 ad.		0,489
123 037 300025	25MM2 UZUN VE KALIN TİP SIKMALI EK MUFU	350 ad.		0,767
123 037 300035	35 MM2 UZUN VE KALIN TİP SIKMALI EK MUFU	200 ad.		1,044
123 037 300050	50 MM2 UZUN VE KALIN TİP SIKMALI EK MUFU	150 ad.		1,240
123 037 300070	70 MM2 UZUN VE KALIN TİP SIKMALI EK MUFU	100 ad.		2,039
123 037 300095	95 MM2 UZUN VE KALIN TİP SIKMALI EK MUFU	70 ad.		2,708
123 037 300120	120 MM2 UZUN VE KALIN TİP SIKMALI EK MUFU	50 ad.		3,263
123 037 300150	150 MM2 UZUN VE KALIN TİP SIKMALI EK MUFU	40 ad.		5,221
123 037 300185	185 MM2 UZUN VE KALIN TİP SIKMALI EK MUFU	30 ad.		6,199
123 037 300240	240 MM2 UZUN VE KALIN TİP SIKMALI EK MUFU	24 ad.		9,397

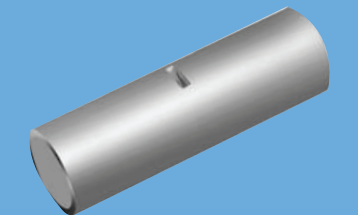

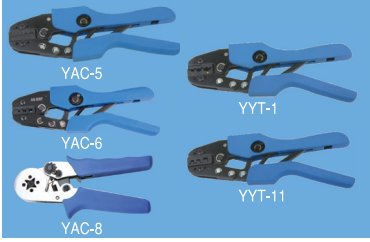

Ürün Kodu	Açıklama / Stok Cinsi	Ambalaj (Kutulu)	Ambalaj Birimi	TL
<b>İZOLELİ TEK GİRİŞLİ YÜKSÜK</b>				
014 100 010508	ITY-0508 İZO.TEK GİRİŞ. YÜKSÜK 0,50 MM	500	ad.	0,016 USD.
014 100 017508	ITY-7508 İZO.TEK GİRİŞ. YÜKSÜK 0,75 MM	500	ad.	0,016 USD.
014 100 011008	ITY-1008 İZO.TEK GİRİŞ. YÜKSÜK 1,00 MM	500	ad.	0,016 USD.
014 100 011508	ITY-1508 İZO.TEK GİRİŞ. YÜKSÜK 1,50 MM	500	ad.	0,016 USD.
014 100 012508	ITY-2508 İZO.TEK GİRİŞ. YÜKSÜK 2,50 MM	500	ad.	0,021 USD.
014 100 014009	ITY-4009 İZO.TEK GİRİŞ. YÜKSÜK 4,00 MM	250	ad.	0,035 USD.
014 100 016012	ITY-6012 İZO.TEK GİRİŞ. YÜKSÜK 6,00 MM	250	ad.	0,047 USD.
014 100 011012	ITY-1012 İZO.TEK GİRİŞ. YÜKSÜK 10,00 MM	100	ad.	0,063 USD.
014 100 011612	ITY-1612 İZO.TEK GİRİŞ. YÜKSÜK 16,00 MM	100	ad.	0,095 USD.
014 100 012516	ITY-2516 İZO.TEK GİRİŞ. YÜKSÜK 25,00 MM	50	ad.	0,182 USD.
014 100 013516	ITY-3516 İZO.TEK GİRİŞ. YÜKSÜK 35,00 MM	40	ad.	0,245 USD.
014 100 015020	ITY-5020 İZO.TEK GİRİŞ. YÜKSÜK 50,00 MM	20	ad.	0,356 USD.

<b>İZOLELİ ÇİFT GİRİŞLİ YÜKSÜK</b>				
014 100 020508	ICY-0508 İZO.ÇİFT GİRİŞ. YÜKSÜK 2X0,5 MM	500	ad.	0,036 USD.
014 100 027508	ICY-7508 İZO.ÇİFT GİRİŞ. YÜKSÜK 2X0,75MM	500	ad.	0,036 USD.
014 100 021008	ICY-1008 İZO.ÇİFT GİRİŞ. YÜKSÜK 2X1 MM	500	ad.	0,036 USD.
014 100 021508	ICY-1508 İZO.ÇİFT GİRİŞ. YÜKSÜK 2X1,5 MM	500	ad.	0,037 USD.
014 100 022510	ICY-2510 İZO.ÇİFT GİRİŞ. YÜKSÜK 2X2,5 MM	250	ad.	0,045 USD.
014 100 024012	ICY-4012 İZO.ÇİFT GİRİŞ. YÜKSÜK 2X4 MM	100	ad.	0,132 USD.
014 100 026014	ICY-6014 İZO.ÇİFT GİRİŞ. YÜKSÜK 2X6 MM	100	ad.	0,140 USD.

<b>İZOLELİ YUVARLAK TİP PAPUÇ</b>				
014 100 030154	IYP-1,5-4 İZO.YUV.TİP PAP. 0,5-1,5MM(M4)	200	ad.	0,045 USD.
014 100 030155	IYP-1,5-5 İZO.YUV.TİP PAP. 0,5-1,5MM(M5)	200	ad.	0,051 USD.
014 100 030156	IYP-1,5-6 İZO.YUV.TİP PAP. 0,5-1,5MM(M6)	200	ad.	0,066 USD.
014 100 030158	IYP-1,5-8 İZO.YUV.TİP PAP. 0,5-1,5MM(M8)	200	ad.	0,071 USD.
014 100 030254	IYP-2,5-4 İZO.YUV.TİP PAP. 1,5-2,5MM(M4)	200	ad.	0,052 USD.
014 100 030255	IYP-2,5-5 İZO.YUV.TİP PAP. 1,5-2,5MM(M5)	200	ad.	0,053 USD.
014 100 030256	IYP-2,5-6 İZO.YUV.TİP PAP. 1,5-2,5MM(M6)	200	ad.	0,077 USD.
014 100 030258	IYP-2,5-8 İZO.YUV.TİP PAP. 1,5-2,5MM(M8)	200	ad.	0,077 USD.
014 100 036004	IYP-6-4 İZO.YUV.TİP PAP. 4-6MM(M4)	100	ad.	0,088 USD.
014 100 036005	IYP-6-5 İZO.YUV.TİP PAP. 4-6 MM(M5)	100	ad.	0,112 USD.
014 100 036006	IYP-6-6 İZO.YUV.TİP PAP. 4-6MM(M6)	100	ad.	0,130 USD.
014 100 036008	IYP-6-8 İZO.YUV.TİP PAP. 4-6MM(M8)	100	ad.	0,147 USD.

<b>YÜKSÜK VE İZOLELİ KABLO UCU SIKMA PENSELERİ</b>				
014 101 005056	YAC-5 YÜKSÜK SIKMA PENSESİ(0,5-6)	1	ad.	72,600 USD.
014 101 006616	YAC-6 YÜKSÜK SIKMA PENSESİ(6-16)	1	ad.	74,250 USD.
014 101 008056	YAC-8 YÜKSÜK SIKMA PENSESİ(0,5-6)(İZOLELİ KABLO UCU)	1	ad.	90,750 USD.
014 101 001056	YYT-1 İZOLELİ KABLO UCU SIKMA PENSESİ(0,5-6)	1	ad.	62,700 USD.
014 101 011014	YYT-11 İZOLELİ KABLO UCU SIKMA PENSESİ(1-4)	1	ad.	72,600 USD.

<b>MEKANİK SKP SIKMA PENSELERİ</b>				
014 101 000650	JY-0650A MEKANİK SKP SIKMA PENSESİ(6-50)	1 ad.		108,900 USD.
014 101 000620	JY-06120 MEKANİK SKP SIKMA PENSESİ(6-120)	1 ad.		172,425 USD.
014 101 025150	JY-25150 MEKANİK SKP SIKMA PENSESİ(25-150)	1 ad.		187,550 USD.
014 101 070240	JY-70240 MEKANİK SKP SIKMA PENSESİ(70-240)	1 ad.		211,750 USD.

<b>HİDROLİK SKP SIKMA PENSELERİ</b>				
014 101 004070	YQK-70 HİDROLİK SKP SIKMA PENSESİ (4-70)	1 ad.		168,665 USD.
014 101 010120	YYQ-120 HİDROLİK SKP SIKMA PENSESİ (10-120)	1 ad.		182,720 USD.
014 101 016240	YQK-240 HİDROLİK SKP SIKMA PENSESİ (16-240)	1 ad.		210,831 USD.
014 101 016300	YQK-300 HİDROLİK SKP SIKMA PENSESİ (16-300)	1 ad.		1.527,763 USD.
014 101 016300	HZ-300 HİDROLİK SKP SIKMA PENSESİ (16-300)	1 ad.		1.527,763 USD.
014 101 016400	HZ-400 HİDROLİK SKP SIKMA PENSESİ (16-400)	1 ad.		1.680,539 USD.

Ürün Kodu	Açıklama / Stok Cinsi	Ambalaj (Kutulu)	Ambalaj Birimi	TL
<b>İZOLELİ ÇATAL TİP PAPUÇ</b>				
014 100 040154	ICP-1,5-4 İZO.ÇTL.TİP PAP. 0,5-1,5MM(M4)	200	ad.	0,048 USD.
014 100 040155	ICP-1,5-5 İZO.ÇTL.TİP PAP. 0,5-1,5MM(M5)	200	ad.	0,056 USD.
014 100 040156	ICP-1,5-6 İZO.ÇTL.TİP PAP. 0,5-1,5MM(M6)	200	ad.	0,066 USD.
014 100 040254	ICP-2,5-4 İZO.ÇTL.TİP PAP. 0,5-1,5MM(M4)	200	ad.	0,051 USD.
014 100 040255	ICP-2,5-5 İZO.ÇTL.TİP PAP. 0,5-1,5MM(M5)	200	ad.	0,056 USD.
014 100 040256	ICP-2,5-6 İZO.ÇTL.TİP PAP. 0,5-1,5MM(M6)	200	ad.	0,070 USD.
014 100 046004	ICP-6-4 İZO.ÇTL.TİP PAP. 4-6 MM(M4)	100	ad.	0,105 USD.
014 100 046005	ICP-6-5 İZO.ÇTL.TİP PAP. 4-6 MM(M5)	100	ad.	0,110 USD.
014 100 046006	ICP-6-6 İZO.ÇTL.TİP PAP. 4-6 MM(M6)	100	ad.	0,117 USD.

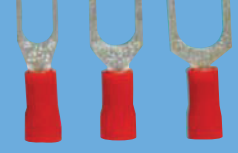

<b>İZOLELİ İĞNE TİP TERMINAL</b>				
014 100 050015	IIT-1,5 İZOLELİ İĞNE TİP TERM.0,5-1,5MM	200	ad.	0,054 USD.
014 100 050025	IIT-2,5 İZOLELİ İĞNE TİP TERM.1,5-2,5MM	200	ad.	0,060 USD.
014 100 050040	IIT-4 İZOLELİ İĞNE TİP TERM.4-6MM	100	ad.	0,117 USD.

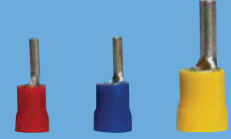

<b>İZOLELİ EK MUF</b>				
014 100 070015	IEM-1,5 İZOLELİ EK MUF 0,5-1,5 MM	100	ad.	0,060 USD.
014 100 070025	IEM-2,5 İZOLELİ EK MUF 1,5-2,5 MM	100	ad.	0,066 USD.
014 100 070040	IEM-4 İZOLELİ EK MUF 4-6 MM	100	ad.	0,104 USD.

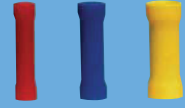

<b>İZOLELİ FASTON ERKEK TERMINAL</b>				
014 100 060015	IFE-1,5 İZO. FASTON ERK. TERM. 1,5 MM	200	ad.	0,104 USD.
014 100 060025	IFE-2,5 İZO. FASTON ERK. TERM. 2,5 MM	200	ad.	0,104 USD.
014 100 060040	IFE-4 İZO. FASTON ERK. TERM. 4 MM	100	ad.	0,151 USD.

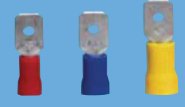

<b>İZOLELİ FASTON DIŞI TERMINAL</b>				
014 100 080510	IDT-0,5-1 İZO. FASTON DIŞI TERM. 0,5-1MM	200	ad.	0,104 USD.
014 100 081525	IDT-1,5-2,5 İZO. FASTON DIŞI TERM. 1,5-2,5MM	200	ad.	0,104 USD.
014 100 084060	IDT-4-6 İZO. FASTON DIŞI TERM. 4-6 MM	100	ad.	0,151 USD.



<b>TAM İZOLELİ DIŞI TERMINAL</b>				
014 100 090510	TDT-0,5-1 TAM İZO.DIŞI TERM. 0,5-1 MM	200	ad.	0,104 USD.
014 100 091525	TDT-1,5-2,5 TAM İZO.DIŞI TERM.1,5-2,5 MM	150	ad.	0,104 USD.
014 100 094060	TDT-4-6 TAM İZO.DIŞI TERM. 4-6 MM	100	ad.	0,161 USD.



<b>YUVARLAK DIŞI TERMINAL</b>				
014 100 100510	YDT-0,5-1 YUV. DIŞI TERM. 0,5-1 MM	200	ad.	0,104 USD.
014 100 101525	YDT-1,5-2,5 YUV. DIŞI TERM. 1,5-2,5 MM	200	ad.	0,104 USD.
014 100 104060	YDT-4-6 YUV. DIŞI TERM. 4-6 MM	100	ad.	0,161 USD.



<b>YUVARLAK ERKEK TERMINAL</b>				
014 100 110510	YET-0,5-1 YUV. ERKEK TERM. 0,5-1 MM	200	ad.	0,070 USD.
014 100 111525	YET-1,5-2,5 YUV. ERKEK TERM.1,5-2,5 MM	200	ad.	0,075 USD.
014 100 114060	YET-4-6 YUV. ERKEK TERM. 4-6 MM	100	ad.	0,131 USD.



<b>FASTON TİP TERMINALLER İZOLESİZ</b>				
065 100 140003	TSF-1-D 6,3 FASTON TİP TERMINAL	200	ad.	0,032 USD.
065 100 140002	TSF-1-D MİNİ 4,8 FASTON TİP TERMINAL	200	ad.	0,041 USD.
065 100 140001	TSF-1-D GÜMÜŞ FASTON TİP TERMINAL	200	ad.	0,045 USD.
065 100 140004	TSF-1-E FASTON TİP TERMINAL	200	ad.	0,032 USD.



## MUTLUSAN SİNYAL VE KUMANDA BUTONLARI



Ürün Kodu : 010 090 010001  
 Ürün Adı : 10 mm KABLULU SİNYAL ARM.  
 Ambalaj Ad. : 100  
 Fiyat : 1,360 TL

Renk :



Ürün Kodu : 010 090 010005  
 Ürün Adı : 14 mm SİNYAL ARM. 12V  
 Ambalaj Ad. : 50  
 Fiyat : 1,827 TL

Renk :



Ürün Kodu : 010 090 010006  
 Ürün Adı : 14 mm SİNYAL ARM. 24V  
 Ambalaj Ad. : 50  
 Fiyat : 1,827 TL

Renk :



Ürün Kodu : 010 090 010007  
 Ürün Adı : 14 mm SİNYAL ARM. 220V  
 Ambalaj Ad. : 50  
 Fiyat : 1,490 TL

Renk :



Ürün Kodu : 010 090 010008  
 Ürün Adı : 22 mm SİNYAL ARM. 12V  
 Ambalaj Ad. : 24  
 Fiyat : 2,430 TL

Renk :



Ürün Kodu : 010 090 010009  
 Ürün Adı : 22 mm SİNYAL ARM. 24V  
 Ambalaj Ad. : 24  
 Fiyat : 2,430 TL

Renk :



Ürün Kodu : 010 090 010010  
 Ürün Adı : 22 mm SİNYAL ARM. 220V  
 Ambalaj Ad. : 24  
 Fiyat : 2,090 TL

Renk :



Ürün Kodu : 010 090 010002  
 Ürün Adı : BA9S DUYLU LEDLİ 22 mm  
 SİN.ARMATÜRÜ 220V

Ambalaj Ad. : 20  
 Fiyat : 4,983 TL



Ürün Kodu : 010 090 010003  
 Ürün Adı : BA9S DUYLU NEON 22 mm  
 SİN.ARMATÜRÜ 220V

Ambalaj Ad. : 20  
 Fiyat : 3,168 TL



Ürün Kodu : 010 090 010004  
 Ürün Adı : 22MM SİNYAL ARMATÜRÜ  
 220V LEDLİ

Ambalaj Ad. : 20  
 Fiyat : 3,993 TL



Ürün Kodu : 010 090 070002  
 Ürün Adı : 22MM SİNYAL ARMATÜRÜ  
 24V LEDLİ

Ambalaj Ad. : 20  
 Fiyat : 4,690 TL



Ürün Kodu : 010 090 040001  
 Ürün Adı : YAYLI START BUTONU  
 Ambalaj Ad. : 20  
 Fiyat : 4,767 TL

Renk :



Ürün Kodu : 010 090 040002  
 Ürün Adı : YAYLI STOP BUTONU  
 Ambalaj Ad. : 20  
 Fiyat : 4,767 TL

Renk :



Ürün Kodu : 010 090 050004  
 Ürün Adı : BA9S NEON AMPÜLLÜ YAYLI  
 IŞIKLI STR.BUT.

Ambalaj Ad. : 20  
 Fiyat : 9,164 TL



Ürün Kodu : 010 090 050006  
 Ürün Adı : BA9S NEON AMPÜLLÜ YAYLI  
 IŞIKLI STP.BUT.

Ambalaj Ad. : 20  
 Fiyat : 9,164 TL

Renk :

## MUTLUSAN SİNYAL VE KUMANDA BUTONLARI



Ürün Kodu : 010 090 050003  
 Ürün Adı : BA9S LEDLİ YAYLI IŞIKLI  
 START BUTONU

Ambalaj Ad. : 20  
 Fiyat : 11,244 TL

Renk :



Ürün Kodu : 010 090 020001  
 Ürün Adı : ESKİ TİP START BUTONU  
 TEK KONTAK

Ambalaj Ad. : 20  
 Fiyat : 4,486 TL



Ürün Kodu : 010 090 050005  
 Ürün Adı : BA9S LEDLİ YAYLI IŞIKLI  
 STOP BUTONU

Ambalaj Ad. : 20  
 Fiyat : 11,244 TL

Renk :



Ürün Kodu : 010 090 020003  
 Ürün Adı : ESKİ TİP STOP BUTONU  
 TEK KONTAK

Ambalaj Ad. : 20  
 Fiyat : 4,486 TL

Renk :



Ürün Kodu : 010 090 040005  
 Ürün Adı : YAYLI MANTAR KAFA  
 BUTON STOP

Ambalaj Ad. : 12  
 Fiyat : 6,117 TL

Renk :



Ürün Kodu : 010 090 050001  
 Ürün Adı : ACİL STOP BUTONU (30'LUK)

Ambalaj Ad. : 12  
 Fiyat : 7,944 TL

Renk :



Ürün Kodu : 010 090 040003  
 Ürün Adı : YAYLI MANTAR KAFA  
 BUTON START

Ambalaj Ad. : 12  
 Fiyat : 6,117 TL

Renk :



Ürün Kodu : 010 090 050002  
 Ürün Adı : ACİL STOP BUTONU (40'LİK)

Ambalaj Ad. : 12  
 Fiyat : 7,944 TL

Renk :



Ürün Kodu : 010 090 030003  
 Ürün Adı : BA9S LEDLİ IŞIKLI SEÇİCİ  
 BUTON 0-1

Ambalaj Ad. : 12  
 Fiyat : 12,369 TL

Renk :



Ürün Kodu : 010 090 040007  
 Ürün Adı : YAYLI İKİZ BUTON

Ambalaj Ad. : 14  
 Fiyat : 10,196 TL

Renk :



Ürün Kodu : 010 090 030004  
 Ürün Adı : BA9S LEDLİ IŞIKLI SEÇİCİ  
 BUTON 11-0-1

Ambalaj Ad. : 12  
 Fiyat : 14,928 TL

Renk :



Ürün Kodu : 010 090 040006  
 Ürün Adı : YAYLI IŞIKLI İKİZ BUTON

Ambalaj Ad. : 14  
 Fiyat : 13,212 TL

Renk :



Ürün Kodu : 010 090 020002  
 Ürün Adı : ESKİ TİP START-STOP BUTONU  
 ÇİFT KONTAK

Ambalaj Ad. : 20  
 Fiyat : 5,608 TL

Renk :



Ürün Kodu : 010 090 030001  
 Ürün Adı : SEÇİCİ BUTON 0-1

Ambalaj Ad. : 12  
 Fiyat : 6,151 TL

Renk :

## MUTLUSAN SİNYAL VE KUMANDA BUTONLARI



Ürün Kodu : 010 090 030002  
 Ürün Adı : SEÇİCİ BUTON 11-0-1  
 Ambalaj Ad. : 12  
 Fiyat : 8,894 TL

Renk : ■



Ürün Kodu : 010 111 070003  
 Ürün Adı : BUZZER 220 VOLT  
 Ambalaj Ad. : 24  
 Fiyat : 12,705 TL



Ürün Kodu : 010 090 030007  
 Ürün Adı : SEÇİCİ BUTON 0-1 ANAHTARLI  
 Ambalaj Ad. : 12  
 Fiyat : 16,993 TL

Renk : ■



Ürün Kodu : 010 111 070004  
 Ürün Adı : BUZZER 24 VOLT  
 Ambalaj Ad. : 24  
 Fiyat : 11,649 TL



Ürün Kodu : 010 090 030008  
 Ürün Adı : SEÇİCİ BUTON 11-0-1 ANAHTARLI  
 Ambalaj Ad. : 12  
 Fiyat : 19,712 TL

Renk : ■



Ürün Kodu : 010 090 030005  
 Ürün Adı : BA9S NEON AMPÜLLÜ İŞIKLI  
 SEÇ.BUT. 0-1  
 Ambalaj Ad. : 12  
 Fiyat : 10,092 TL

Renk : ■



Ürün Kodu : 010 090 050007  
 Ürün Adı : ANAHTARLI ACIL STOP  
 BUTONU (40'LİK)  
 Ambalaj Ad. : 12  
 Fiyat : 19,115 TL

Renk : ■



Ürün Kodu : 010 090 030006  
 Ürün Adı : BA9S NEON AMPÜLLÜ İŞIKLI  
 SEÇ.BUT. 11-0-1  
 Ambalaj Ad. : 12  
 Fiyat : 12,678 TL

Renk : ■



Ürün Kodu : 010 091 020002  
 Ürün Adı : YÖN İŞARETLİ START BUTONU  
 22 mm SİNYAL ARM, 220V  
 Ambalaj Ad. : 20  
 Fiyat : 5,242TL  
 Renk : □ ■ ■ ■ ■



Ürün Kodu : 010 093 000003  
 Ürün Adı : ACIL DURDURMA ETİKETİ  
 Ambalaj Ad. : 50  
 Fiyat : 3,059 TL  
 Renk : ■



Ürün Kodu : 010 111 070001  
 Ürün Adı : BUZZER 220 VOLT LEDLİ  
 Ambalaj Ad. : 24  
 Fiyat : 14,883TL



Ürün Kodu : 010 090 050008  
 Ürün Adı : EMNİYET BASMA DÜĞMESİ  
 MUHAFAZA  
 Ambalaj Ad. : 50  
 Fiyat : 1,189 TL



Ürün Kodu : 010 111 070002  
 Ürün Adı : BUZZER 24 VOLT LEDLİ  
 Ambalaj Ad. : 24  
 Fiyat : 13,761 TL



Ürün Kodu : 010 093 000001  
 Ürün Adı : SİLİKON TOZ KILIFI  
 Ambalaj Ad. : 50  
 Fiyat : 2,549 TL

Renk : □

## MUTLUSAN SİNYAL VE KUMANDA BUTONLARI



Ürün Kodu : 010 093 000004  
 Ürün Adı : YEDEK KONTAK BLOK  
 Ambalaj Ad. : 50  
 Fiyat : 3,317 TL

Renk :



Ürün Kodu : 010 093 000005  
 Ürün Adı : IŞIK SOKETİ  
 Ambalaj Ad. : 20  
 Fiyat : 3,092 TL

Renk :



Ürün Kodu : 010 093 000002  
 Ürün Adı : BUTON ETİKETİ  
 Ambalaj Ad. : 50  
 Fiyat : 0,680 TL

Renk :

## EUROBOX ETANJ BUTON KUTULARI (YENİ MODEL)



Ürün Kodu : 010 091 010001  
 Ürün Adı : 1 Lİ ETANJ BUTON KUTUSU  
 Ambalaj Ad. : 24  
 Fiyat : 6,044 TL  
 Renk :



Ürün Kodu : 010 091 010002  
 Ürün Adı : 2 Lİ ETANJ BUTON KUTUSU  
 Ambalaj Ad. : 18  
 Fiyat : 7,168 TL  
 Renk :



Ürün Kodu : 010 091 010003  
 Ürün Adı : 3 LÜ ETANJ BUTON KUTUSU  
 Ambalaj Ad. : 12  
 Fiyat : 9,346 TL  
 Renk :



Ürün Kodu : 010 091 010004  
 Ürün Adı : 4 LÜ ETANJ BUTON KUTUSU  
 Ambalaj Ad. : 10  
 Fiyat : 11,216 TL  
 Renk :



Ürün Kodu : 010 090 050009  
 Ürün Adı : TEKLİ ACİL STOPLU KUTU  
 Ambalaj Ad. : 18  
 Fiyat : 17,429 TL  
 Renk :



Ürün Kodu : 010 091 020001  
 Ürün Adı : ASANSÖR REVİZYON 4LÜ KUTU  
 Ambalaj Ad. : 6  
 Fiyat : 44,977 TL  
 Renk :

## VİNÇ KUTULARI



Ürün Kodu : 010 092 000001  
 Ürün Adı : İKİLİ VİNÇ KUTUSU (TEK HIZLI)  
 Ambalaj Ad. : 1  
 Fiyat : 47,507 TL



Ürün Kodu : 010 092 000002  
 Ürün Adı : ÜÇLÜ VİNÇ KUTUSU (TEK HIZLI)  
 Ambalaj Ad. : 1  
 Fiyat : 55,378 TL



Ürün Kodu : 010 092 000003  
 Ürün Adı : DÖRTLÜ VİNÇ KUTUSU  
(TEK HIZLI)  
 Ambalaj Ad. : 1  
 Fiyat : 75,618 TL



Ürün Kodu : 010 092 000004  
 Ürün Adı : BEŞLİ VİNÇ KUTUSU (TEK HIZLI)  
 Ambalaj Ad. : 1  
 Fiyat : 83,208 TL



Ürün Kodu : 010 092 000005  
 Ürün Adı : ALTILI VİNÇ KUTUSU (TEK HIZLI)  
 Ambalaj Ad. : 1  
 Fiyat : 112,443 TL

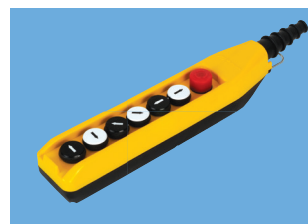

Ürün Kodu : 010 092 000006  
 Ürün Adı : YEDİLİ VİNÇ KUTUSU (TEK HIZLI)  
 Ambalaj Ad. : 1  
 Fiyat : 120,033 TL

## GÜNEŞ ENERJİLİ "SOLAR PANEL" İKAZ LAMBALARI

2 yıl garantili  
Rf dalga yaymaz  
Stabilize ışık çıkışı  
12 yıl uzun ömürlü  
Uv ışınlarına karşı dayanıklı  
Görünebilirlik mesafesi 10 km  
Her türlü yüzeye kolay montaj  
Sabit, flaşör, çakar, döner çalışma fonksiyonları  
Foto sensör yardımıyla gece ve gündüz algılama



Güneş Enerjili  
**SOLAR**  
İkaz Lambaları

007 087 400108

007 087 400107

MULTİ SERİSİ  
STANDART VE ŞARJLI İKAZ LAMBALARI

2 yıl garantili  
Stabilize ışık çıkışı  
Her türlü yüzeye kolay montaj  
Sabit, flaşör, çakar ve döner çalışma fonksiyonları



007 087 400101

007 087 400105

## İL-X SERİSİ Ø90mm GÜNEŞ ENERJİ "SOLAR PANEL" İKAZ LAMBALARI

ÜRÜN KODU	ÇALIŞMA ŞEKLİ	BESLEME GERİLİMİ	MODEL	FİYAT
-----------	---------------	------------------	-------	-------

## T90 SOLAR İKAZ LAMBASI

007 087 400106	ÇAKAR	12V	İL-XSLM-912V-TMK	160,000 USD.
----------------	-------	-----	------------------	--------------

## T90 SOLAR KULE İKAZ LAMBASI SETİ

007 087 400107	ÇAKAR	12V	İL-XSL20M-TMK	500,000 USD.
----------------	-------	-----	---------------	--------------

## T90 SOLAR AYAKLI İKAZ LAMBASI SETİ

007 087 400108	ÇAKAR	12V	İL-XSL20M-KMK	500,000 USD.
----------------	-------	-----	---------------	--------------



Multi Serisi ile Tek gövdede 4 ayrı seçenek

## İL-X...VT9 SERİSİ MULTİ VE ŞARJLI İKAZ LAMBALARI

ÜRÜN KODU	ÇALIŞMA ŞEKLİ	BESLEME GERİLİMİ	MODEL	FİYAT
-----------	---------------	------------------	-------	-------

## T90 MULTI SERİ TEK GÖVDE 4 FARKLI ÇALIŞMA ÖZELLİĞİ

007 087 400101	Multi	24VDC	İL-XLM-VT9-24K	42,000 USD.
007 087 400102	Multi	220VAC	İL-XLM-VT9-220K	48,000 USD.
007 087 400103	Multi+Buzzer	24VAC	İL-XLMB-VT9-24K	42,000 USD.
007 087 400104	Multi+Buzzer	220VAC	İL-XLMB-VT9-220K	48,000 USD.

## T90 ŞARJLI SERİ TEK GÖVDE 4 FARKLI ÇALIŞMA ÖZELLİĞİ

007 087 400105	Multi	12V	İL-XJM-MM9-12K	150,000 USD.
----------------	-------	-----	----------------	--------------

## RENKLER



Temperature



High IP value

Shock /  
Vibration  
resistantMagnetic  
field proofPower  
LED Light

## IL-X....VT6 SERİSİ TEK GÖVDE'DE 5 RENK İKAZ LAMBALARI

ÜRÜN KODU	ÇALIŞMA ŞEKLİ	BESLEME GERİLİMİ	MODEL	FİYAT
<b>IL-XP..-VT6 Serisi İkaz Lambaları</b>				
129 087 000431	Sabit Işıklı	24VDC	IL-XLS-VT6-243-A2	40,000 USD.
129 087 000432	Sabit Işıklı	220VAC	IL-XLS-VT6-2203-A2	45,000 USD.
129 087 000433	Flaşörlü	24VDC	IL-XLF-VT6-243-A2	45,000 USD.
129 087 000434	Flaşörlü	220VAC	IL-XLF-VT6-2203-A2	50,000 USD.
129 087 000435	Çakar	24VDC	IL-XLÇ-VT6-243-A2	50,000 USD.
129 087 000436	Çakar	220VAC	IL-XLÇ-VT6-2203-A2	55,000 USD.

### IL-XP..-VT6 Serisi Buzzerli İkaz Lambaları

129 087 000412	Sabit Işıklı +Buzzer	24VDC	IL-XLSB-VT6-243-A2	45,000 USD.
129 087 000413	Sabit Işıklı +Buzzer	220VAC	IL-XLSB-VT6-2203-A2	50,000 USD.
129 087 000414	Flaşörlü +Buzzer	24VDC	IL-XLFB-VT6-243-A2	50,000 USD.
129 087 000415	Flaşörlü +Buzzer	220VAC	IL-XLFB-VT6-2203-A2	55,000 USD.
129 087 000416	Çakar +Buzzer	24VDC	IL-XLÇB-VT6-243-A2	55,000 USD.
129 087 000417	Çakar +Buzzer	220VAC	IL-XLÇB-VT6-2203-A2	60,000 USD.
129 087 000418	Konnektörlü tipler için güç konnektörü		IL-XM125	20,000 USD.



## IL-X....F7 SERİSİ 12... 80 V/DC MOBİL UYGULAMA İÇİN İKAZ LAMBALARI

ÜRÜN KODU	ÇALIŞMA ŞEKLİ	BESLEME GERİLİMİ	MODEL	FİYAT
<b>IL-XP..-F7 Serisi İkaz Lambaları</b>				
129 087 000419	Sabit Işıklı	12...80VDC	IL-XS-F7-80-A2	40,000 USD.
129 087 000420	Sabit Işıklı	220VAC	IL-XS-F7-220-A2	45,000 USD.
129 087 000421	Flaşörlü	12...80VDC	IL-XF-F7-80-A2	45,000 USD.
129 087 000422	Flaşörlü	220VAC	IL-XF-F7-220-A2	50,000 USD.
129 087 000423	Çakar	12...80VDC	IL-XÇ-F7-80-A2	50,000 USD.
129 087 000424	Çakar	220VAC	IL-XÇ-F7-220-A2	55,000 USD.

### IL-XP..-F7 Serisi Buzzerli İkaz Lambaları

129 087 000425	Sabit Işıklı +Buzzer	12...80VDC	IL-XSB-F7-80-A2	45,000 USD.
129 087 000426	Sabit Işıklı +Buzzer	220VAC	IL-XSB-F7-220-A2	50,000 USD.
129 087 000427	Flaşörlü +Buzzer	12...80VDC	IL-XFB-F7-80-A2	50,000 USD.
129 087 000428	Flaşörlü +Buzzer	220VAC	IL-XFB-F7-220-A2	55,000 USD.
129 087 000429	Çakar +Buzzer	12...80VDC	IL-XÇB-F7-80-A2	55,000 USD.
129 087 000430	Çakar +Buzzer	220VAC	IL-XÇB-F7-220-A2	60,000 USD.

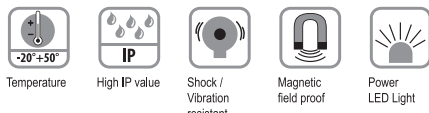

**Işıklı kolonlarda kırmızı sabit renktir. Diğer renkler siparişle yapılabilmektedir.**

## GENİŞ ÇALIŞMA AKIMI 12VDC to 80VDC



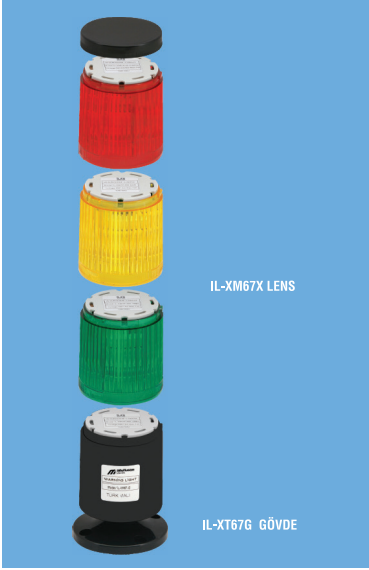

Ürün Kodu	Çalışma Şekli	Montaj Şekli	Besleme Gerilimi	Ambalaj (Poşet)	Ambalaj Birimi	Fiyat
<b>IL-XM67 SERİSİ Ø 67 MODÜLER SİSTEM İKAZ LAMBA LENSLERİ</b>						
129 087 000015	IL-XM67S-24	SABİT IŞIKLI	TABANA MONTAJ	24VAC/DC	1 ad.	41,450 USD.
129 087 000018	IL-XM67S-220	SABİT IŞIKLI	TABANA MONTAJ	220VAC	1 ad.	45,000 USD.
129 087 000020	IL-XM67F-24	FLAŞÖRLÜ	TABANA MONTAJ	24VAC/DC	1 ad.	49,970 USD.
129 087 000023	IL-XM67F-220	FLAŞÖRLÜ	TABANA MONTAJ	220VAC	1 ad.	55,000 USD.
129 087 000025	IL-XM67Ç-24	ÇAKAR	TABANA MONTAJ	24VAC/DC	1 ad.	64,000 USD.
129 087 000028	IL-XM67Ç-220	ÇAKAR	TABANA MONTAJ	220VAC	1 ad.	64,000 USD.
129 087 000030	IL-XM67D-24	DÖNER	TABANA MONTAJ	24VAC/DC	1 ad.	59,050 USD.
129 087 000033	IL-XM67D-220	DÖNER	TABANA MONTAJ	220VAC	1 ad.	64,000 USD.
129 087 000035	IL-XM67B-24	BUZZER	TABANA MONTAJ	24VAC/DC	1 ad.	32,930 USD.
129 087 000038	IL-XM67B-220	BUZZER	TABANA MONTAJ	220VAC	1 ad.	37,000 USD.
129 087 000039	IL-XT67-G	GÖVDE			1 ad.	25,550 USD.

<b>IL-X...-T5 SERİSİ Ø 52 1 KATLI IŞIKLI KOLONLAR</b>						
129 087 000278	IL-XLS-T5-241	SABİT IŞIKLI	TABANA MONTAJ	24VDC	1 ad.	28,390 USD.
129 087 000279	IL-XLS-T5-2201	SABİT IŞIKLI	TABANA MONTAJ	220VAC	1 ad.	34,070 USD.
129 087 000281	IL-XLF-T5-241	FLAŞÖRLÜ	TABANA MONTAJ	24VDC	1 ad.	43,150 USD.
129 087 000282	IL-XLF-T5-2201	FLAŞÖRLÜ	TABANA MONTAJ	220VAC	1 ad.	46,560 USD.
129 087 000284	IL-XÇ-T5-241	ÇAKAR	TABANA MONTAJ	24VDC	1 ad.	39,750 USD.
129 087 000285	IL-XÇ-T5-2201	ÇAKAR	TABANA MONTAJ	220VAC	1 ad.	45,420 USD.
129 087 000287	IL-XLSB-T5-241	SABİT IŞIKLI + BUZZER	TABANA MONTAJ	24VDC	1 ad.	45,420 USD.
129 087 000288	IL-XLSB-T5-2201	SABİT IŞIKLI + BUZZER	TABANA MONTAJ	220VAC	1 ad.	51,100 USD.
129 087 000290	IL-XLFB-T5-241	FLAŞÖRLÜ + BUZZER	TABANA MONTAJ	24VDC	1 ad.	54,510 USD.
129 087 000291	IL-XLFB-T5-2201	FLAŞÖRLÜ + BUZZER	TABANA MONTAJ	220VAC	1 ad.	60,190 USD.
129 087 000293	IL-XÇB-T5-24	ÇAKAR + BUZZER	TABANA MONTAJ	24VDC	1 ad.	51,100 USD.
129 087 000294	IL-XÇB-T5-220	ÇAKAR + BUZZER	TABANA MONTAJ	220 VAC	1 ad.	56,780 USD.

<b>IL-X...-T5 SERİSİ Ø 52 2 KATLI IŞIKLI KOLONLAR</b>						
129 087 000296	IL-XLS-T5-242	SABİT IŞIKLI	TABANA MONTAJ	24VDC	1 ad.	39,750 USD.
129 087 000297	IL-XLS-T5-2202	SABİT IŞIKLI	TABANA MONTAJ	220VAC	1 ad.	42,580 USD.
129 087 000299	IL-XLF-T5-242	FLAŞÖRLÜ	TABANA MONTAJ	24VDC	1 ad.	47,690 USD.
129 087 000300	IL-XLF-T5-2202	FLAŞÖRLÜ	TABANA MONTAJ	220VAC	1 ad.	56,780 USD.
129 087 000302	IL-XLSB-T5-242	SABİT IŞIKLI + BUZZER	TABANA MONTAJ	24 VDC	1 ad.	52,240 USD.
129 087 000303	IL-XLSB-T5-2202	SABİT IŞIKLI + BUZZER	TABANA MONTAJ	220 VAC	1 ad.	57,910 USD.
129 087 000305	IL-XLFB-T5-242	FLAŞÖRLÜ + BUZZER	TABANA MONTAJ	24 VDC	1 ad.	59,050 USD.
129 087 000306	IL-XLFB-T5-2202	FLAŞÖRLÜ + BUZZER	TABANA MONTAJ	220 VAC	1 ad.	64,730 USD.

<b>IL-X...-T5 SERİSİ Ø 52 3 KATLI IŞIKLI KOLONLAR</b>						
129 087 000308	IL-XLS-T5-243	SABİT IŞIKLI	TABANA MONTAJ	24VDC	1 ad.	42,580 USD.
129 087 000309	IL-XLS-T5-2203	SABİT IŞIKLI	TABANA MONTAJ	220VAC	1 ad.	45,420 USD.
129 087 000311	IL-XLF-T5-243	FLAŞÖRLÜ	TABANA MONTAJ	24VDC	1 ad.	54,510 USD.
129 087 000312	IL-XLF-T5-2203	FLAŞÖRLÜ	TABANA MONTAJ	220VAC	1 ad.	60,190 USD.
129 087 000314	IL-XLSB-T5-243	SABİT IŞIKLI + BUZZER	TABANA MONTAJ	24VDC	1 ad.	65,860 USD.
129 087 000315	IL-XLSB-T5-2203	SABİT IŞIKLI + BUZZER	TABANA MONTAJ	220VAC	1 ad.	71,540 USD.
129 087 000317	IL-XLFB-T5-243	FLAŞÖRLÜ + BUZZER	TABANA MONTAJ	24VDC	1 ad.	71,540 USD.
129 087 000318	IL-XLFB-T5-2203	FLAŞÖRLÜ + BUZZER	TABANA MONTAJ	220VAC	1 ad.	77,220 USD.

<b>IL-X...-T5 SERİSİ Ø 52 4 KATLI IŞIKLI KOLONLAR</b>						
129 087 000254	IL-XLS-T5-244	SABİT IŞIKLI	TABANA MONTAJ	24VDC	1 ad.	48,260 USD.
129 087 000255	IL-XLS-T5-2204	SABİT IŞIKLI	TABANA MONTAJ	220VAC	1 ad.	56,780 USD.
129 087 000257	IL-XLF-T5-244	FLAŞÖRLÜ	TABANA MONTAJ	24VDC	1 ad.	62,460 USD.
129 087 000258	IL-XLF-T5-2204	FLAŞÖRLÜ	TABANA MONTAJ	220VAC	1 ad.	70,410 USD.
129 087 000260	IL-XLSB-T5-244	SABİT IŞIKLI + BUZZER	TABANA MONTAJ	24VDC	1 ad.	73,810 USD.
129 087 000261	IL-XLSB-T5-2204	SABİT IŞIKLI + BUZZER	TABANA MONTAJ	220VAC	1 ad.	81,760 USD.
129 087 000263	IL-XLFB-T5-244	FLAŞÖRLÜ + BUZZER	TABANA MONTAJ	24VDC	1 ad.	81,760 USD.
129 087 000264	IL-XLFB-T5-2204	FLAŞÖRLÜ + BUZZER	TABANA MONTAJ	220VAC	1 ad.	90,850 USD.

<b>IL-X...-T5 SERİSİ Ø 52 5 KATLI IŞIKLI KOLONLAR</b>						
129 087 000266	IL-XLS-T5-245	SABİT IŞIKLI	TABANA MONTAJ	24VDC	1 ad.	52,240 USD.
129 087 000267	IL-XLS-T5-2205	SABİT IŞIKLI	TABANA MONTAJ	220VAC	1 ad.	61,320 USD.
129 087 000269	IL-XLF-T5-245	SABİT IŞIKLI	TABANA MONTAJ	24VDC	1 ad.	68,140 USD.
129 087 000270	IL-XLF-T5-2205	SABİT IŞIKLI	TABANA MONTAJ	220VAC	1 ad.	88,580 USD.
129 087 000272	IL-XLSB-T5-245	SABİT IŞIKLI + BUZZER	TABANA MONTAJ	24VDC	1 ad.	79,490 USD.
129 087 000273	IL-XLSB-T5-2205	SABİT IŞIKLI + BUZZER	TABANA MONTAJ	220VAC	1 ad.	88,580 USD.
129 087 000275	IL-XLFB-T5-245	FLAŞÖRLÜ + BUZZER	TABANA MONTAJ	24VDC	1 ad.	90,850 USD.
129 087 000276	IL-XLFB-T5-2205	FLAŞÖRLÜ + BUZZER	TABANA MONTAJ	220VAC	1 ad.	102,200 USD.

RENK SEÇENEKLERİ: IL-XM67S-12K ● IL-XM67S-12S ● IL-XM67S-12Y ● IL-XM67S-12M ● IL-XM67S-12B ○

**Işıklı kolonlarda kırmızı sabit renktir. Diğer renkler siparişle yapılabilmektedir. "GOETHE"**

Ürün Kodu	Çalışma Şekli	Montaj Şekli	Besleme Gerilimi	Ambalaj (Poşet)	Ambalaj Birimi	Fiyat
<b>L-X...VT6 SERİSİ Ø 60 İKAZ LAMBALARI</b>						
29 087 000040	IL-XLS-VT6-24K	SABİT IŞIKLI	TABANA MONTAJ	24VDC	1 ad.	39,750 USD.
29 087 000041	IL-XLS-VT6-220K	SABİT IŞIKLI	TABANA MONTAJ	220VAC	1 ad.	45,420 USD.
129 087 000043	IL-XLF-VT6-24K	FLAŞÖRLÜ	TABANA MONTAJ	24VDC	1 ad.	48,830 USD.
129 087 000044	IL-XLF-VT6-220K	FLAŞÖRLÜ	TABANA MONTAJ	220VAC	1 ad.	55,640 USD.
29 087 000046	IL-XÇ-VT6-24K	ÇAKAR	TABANA MONTAJ	24VDC	1 ad.	65,860 USD.
29 087 000047	IL-XÇ-VT6-220K	ÇAKAR	TABANA MONTAJ	220VAC	1 ad.	65,860 USD.
129 087 000050	IL-XLD-VT6-24K	LEDLİ DÖNER	TABANA MONTAJ	24VDC	1 ad.	60,190 USD.
129 087 000051	IL-XLD-VT6-220K	LEDLİ DÖNER	TABANA MONTAJ	220VAC	1 ad.	68,140 USD.
129 087 000053	IL-XLSB-VT6-24K	SABİT IŞIKLI+BUZZER	TABANA MONTAJ	24VDC	1 ad.	51,100 USD.
129 087 000054	IL-XLSB-VT6-220K	SABİT IŞIKLI+BUZZER	TABANA MONTAJ	220VAC	1 ad.	56,780 USD.
129 087 000056	IL-XLFB-VT6-24K	FLAŞÖRLÜ+BUZZER	TABANA MONTAJ	24VDC	1 ad.	56,780 USD.
129 087 000057	IL-XLFB-VT6-220K	FLAŞÖRLÜ+BUZZER	TABANA MONTAJ	220VAC	1 ad.	62,460 USD.
129 087 000059	IL-XÇB-VT6-24K	ÇAKAR+BUZZER	TABANA MONTAJ	24VDC	1 ad.	85,170 USD.
129 087 000060	IL-XÇB-VT6-220K	ÇAKAR+BUZZER	TABANA MONTAJ	220VAC	1 ad.	85,170 USD.
129 087 000062	IL-XLDB-VT6-24K	LEDLİ DÖNER+BUZZER	TABANA MONTAJ	24VDC	1 ad.	72,680 USD.
129 087 000063	IL-XLDB-VT6-220K	LEDLİ DÖNER+BUZZER	TABANA MONTAJ	220VAC	1 ad.	79,490 USD.



IL-X...VT6 SERİSİ

<b>İL-XV8 SERİSİ Q 84 İKAZ LAMBALARI</b>						
129 087 000065	IL-XLS-V8-24K	SABİT IŞIKLI	VİDA BAĞLANTI	24VDC	1 ad.	45,420USD
129 087 000066	IL-XLS-V8-220K	SABİT IŞIKLI	VİDA BAĞLANTI	220VAC	1 ad.	51,100USD
129 087 000068	IL-XLF-V8-24K	FLAŞÖRLÜ	VİDA BAĞLANTI	24VDC	1 ad.	48,380USD
129 087 000069	IL-XLF-V8-220K	FLAŞÖRLÜ	VİDA BAĞLANTI	220VAC	1 ad.	54,050USD.
129 087 000071	IL-XÇ-V8-24K	ÇAKAR	VİDA BAĞLANTI	24VDC	1 ad.	45,420USD.
129 087 000072	IL-XÇ-V8-220K	ÇAKAR	VİDA BAĞLANTI	220VAC	1 ad.	51,100USD.
129 087 000075	IL-XLD-V8-24K	LEDLİ DÖNER	VİDA BAĞLANTI	24VDC	1 ad.	56,780USD.
129 087 000076	IL-XLD-V8-220K	LEDLİ DÖNER	VİDA BAĞLANTI	220VAC	1 ad.	62,460USD.
129 087 000078	IL-XLSB-V8-24K	SABİT IŞIKLI+BUZZER	VİDA BAĞLANTI	24VDC	1 ad.	48,260USD.
129 087 000079	IL-XLSB-V8-220K	SABİT IŞIKLI+BUZZER	VİDA BAĞLANTI	220VAC	1 ad.	53,940USD.
129 087 000081	IL-XLFB-V8-24K	FLAŞÖRLÜ+BUZZER	VİDA BAĞLANTI	24VDC	1 ad.	51,100USD.
129 087 000082	IL-XLFB-V8-220K	FLAŞÖRLÜ+BUZZER	VİDA BAĞLANTI	220VAC	1 ad.	56,780USD.
129 087 000084	IL-XÇB-V8-24K	ÇAKAR+BUZZER	VİDA BAĞLANTI	24VDC	1 ad.	56,780USD.
129 087 000085	IL-XÇB-V8-220K	ÇAKAR+BUZZER	VİDA BAĞLANTI	220VAC	1 ad.	62,460USD.
129 087 000087	IL-XLDB-V8-24K	LEDLİ DÖNER+BUZZER	VİDA BAĞLANTI.	24VDC	1 ad.	71,540USD.
129 087 000088	IL-XLDB-V8-220K	LEDLİ DÖNER+BUZZER	VİDA BAĞLANTI	220VAC	1 ad.	77,220USD.



İL-X...V8 SERİSİ

<b>SABİT IŞIKLI İL-X-T8 SERİSİ İKAZ LAMBALARI</b>						
129 087 000090	IL-XLS-T8-24K	SABİT IŞIKLI	TABANA MONTAJ	24VDC	1 ad.	45,420 USD.
129 087 000091	IL-XLS-T8-220K	SABİT IŞIKLI	TABANA MONTAJ	220VAC	1 ad.	51,100 USD.
129 087 000093	IL-XLF-T8-24K	FLAŞÖRLÜ	TABANA MONTAJ	24VDC	1 ad.	48,380 USD.
129 087 000094	IL-XLF-T8-220K	FLAŞÖRLÜ	TABANA MONTAJ	220VAC	1 ad.	54,050 USD.
129 087 000096	IL-XÇ-T8-24K	ÇAKAR	TABANA MONTAJ	24VDC	1 ad.	45,420 USD.
129 087 000097	IL-XÇ-T8-220K	ÇAKAR	TABANA MONTAJ	220VAC	1 ad.	51,100 USD.
129 087 000100	IL-XLD-T8-24K	LEDLİ DÖNER	TABANA MONTAJ	24VDC	1 ad.	56,780 USD.
129 087 000101	IL-XLD-T8-220K	LEDLİ DÖNER	TABANA MONTAJ	220VAC	1 ad.	62,460 USD.
129 087 000103	IL-XLSB-T8-24K	SABİT IŞIKLI+BUZZER	TABANA MONTAJ	24VDC	1 ad.	48,260 USD.
129 087 000104	IL-XLSB-T8-220K	SABİT IŞIKLI+BUZZER	TABANA MONTAJ	220VAC	1 ad.	53,940 USD.
129 087 000106	IL-XLFB-T8-24K	FLAŞÖRLÜ+BUZZER	TABANA MONTAJ	24VDC	1 ad.	51,100 USD.
129 087 000107	IL-XLFB-T8-220K	FLAŞÖRLÜ+BUZZER	TABANA MONTAJ	220VAC	1 ad.	56,780 USD.
129 087 000109	IL-XÇB-T8-24K	ÇAKAR+BUZZER	TABANA MONTAJ	24VDC	1 ad.	56,780 USD.
129 087 000110	IL-XÇB-T8-220K	ÇAKAR+BUZZER	TABANA MONTAJ	220VAC	1 ad.	62,460 USD.
129 087 000112	IL-XLDB-T8-24K	LEDLİ DÖNER+BUZZER	TABANA MONTAJ	24VDC	1 ad.	71,540 USD.
129 087 000113	IL-XLDB-T8-220K	LEDLİ DÖNER+BUZZER	TABANA MONTAJ	220VDC	1 ad.	77,220 USD.



İL-X...T8 SERİSİ

RENK SEÇENEKLERİ: IL-XLS-T8-12K ● IL-XLS-T8-12S ● IL-XLS-T8-12Y ● IL-XLS-T8-12M ● IL-XLS-T8-12B ○

İşikli kolonlarda kırmızı sabit renktir. Diğer renkler siparişle yapılabilmektedir.



IL-X...-VT8 SERİSİ



IL-X...-VT10 SERİSİ



IL-X...-VT12 SERİSİ

Ürün Kodu	Çalışma Şekli	Montaj Şekli	Besleme Gerilimi	Ambalaj (Poşet)	Ambalaj Birimi	Fiyat
<b>IL-X-VT..8 SERİSİ Ø 84 İKAZ LAMBALARI</b>						
129 087 000115	IL-XLS-VT8-24K	SABİT İŞIKLI	TABANA MONTAJ	24VDC	1 ad.	45,420 USD.
129 087 000116	IL-XLS-VT8-220K	SABİT İŞIKLI	TABANA MONTAJ	220VAC	1 ad.	51,100 USD.
129 087 000118	IL-XLF-VT8-24K	FLAŞÖRLÜ	TABANA MONTAJ	24VDC	1 ad.	48,380 USD.
129 087 000119	IL-XLF-VT8-220K	FLAŞÖRLÜ	TABANA MONTAJ	220VAC	1 ad.	54,050 USD.
129 087 000121	IL-XÇ-VT8-24K	ÇAKAR	TABANA MONTAJ	24VDC	1 ad.	45,420 USD.
129 087 000122	IL-XÇ-VT8-220K	ÇAKAR	TABANA MONTAJ	220VAC	1 ad.	51,100 USD.
129 087 000125	IL-XLD-VT8-24K	LEDLİ DÖNER	TABANA MONTAJ	24VDC	1 ad.	56,780 USD.
129 087 000126	IL-XLD-VT8-220K	LEDLİ DÖNER	TABANA MONTAJ	220VAC	1 ad.	62,460 USD.
129 087 000128	IL-XLSB-VT8-24K	SABİT İŞIKLI+BUZZER	TABANA MONTAJ	24VDC	1 ad.	48,260 USD.
129 087 000129	IL-XLSB-VT8-220K	SABİT İŞIKLI+BUZZER	TABANA MONTAJ	220VAC	1 ad.	53,940 USD.
129 087 000131	IL-XLFB-VT8-24K	FLAŞÖRLÜ+BUZZER	TABANA MONTAJ	24VDC	1 ad.	51,100 USD.
129 087 000132	IL-XLFB-VT8-220K	FLAŞÖRLÜ+BUZZER	TABANA MONTAJ	220VAC	1 ad.	56,780 USD.
129 087 000134	IL-XÇB-VT8-24K	ÇAKAR+BUZZER	TABANA MONTAJ	24VDC	1 ad.	56,780 USD.
129 087 000135	IL-XÇB-VT8-220K	ÇAKAR+BUZZER	TABANA MONTAJ	220VAC	1 ad.	62,460 USD.
129 087 000137	IL-XLDB-VT8-24K	LEDLİ DÖNER+BUZZER	TABANA MONTAJ	24VDC	1 ad.	71,540 USD.
129 087 000138	IL-XLDB-VT8-220K	LEDLİ DÖNER+BUZZER	TABANA MONTAJ	220VAC	1 ad.	77,220 USD.
<b>IL-X...-VT10 SERİSİ Ø 100 İKAZ LAMBALARI</b>						
129 087 000140	IL-XLS-VT10-24K	SABİT İŞIKLI	TABANA MONTAJ	24VDC	1 ad.	59,620 USD.
129 087 000141	IL-XLS-VT10-220K	SABİT İŞIKLI	TABANA MONTAJ	220VAC	1 ad.	65,300 USD.
129 087 000143	IL-XLF-VT10-24K	FLAŞÖRLÜ	TABANA MONTAJ	24VDC	1 ad.	68,140 USD.
129 087 000144	IL-XLF-VT10-220K	FLAŞÖRLÜ	TABANA MONTAJ	220VAC	1 ad.	76,940 USD.
129 087 000146	IL-XÇ-VT10-24K	ÇAKAR	TABANA MONTAJ	24VDC	1 ad.	78,360 USD.
129 087 000147	IL-XÇ-VT10-220K	ÇAKAR	TABANA MONTAJ	220VAC	1 ad.	89,710 USD.
129 087 000150	IL-XLD-VT10-24K	LEDLİ DÖNER	TABANA MONTAJ	24VDC	1 ad.	78,360 USD.
129 087 000151	IL-XLD-VT10-220K	LEDLİ DÖNER	TABANA MONTAJ	220VAC	1 ad.	89,710 USD.
129 087 000153	IL-XLSB-VT10-24K	SABİT İŞIKLI + BUZZER	TABANA MONTAJ	24VDC	1 ad.	59,050 USD.
129 087 000154	IL-XLSB-VT10-220K	SABİT İŞIKLI + BUZZER	TABANA MONTAJ	220VAC	1 ad.	68,140 USD.
129 087 000156	IL-XLFB-VT10-24K	FLAŞÖRLÜ + BUZZER	TABANA MONTAJ	24VDC	1 ad.	71,540 USD.
129 087 000157	IL-XLFB-VT10-220K	FLAŞÖRLÜ + BUZZER	TABANA MONTAJ	220VAC	1 ad.	82,900 USD.
129 087 000159	IL-XÇB-VT10-24K	ÇAKAR + BUZZER	TABANA MONTAJ	24VDC	1 ad.	124,910 USD.
129 087 000160	IL-XÇB-VT10-220K	ÇAKAR + BUZZER VİDA	TABANA MONTAJ	220VAC	1 ad.	136,270 USD.
129 087 000162	IL-XLDB-VT10-24K	LEDLİ DÖNER + BUZZER	TABANA MONTAJ	24VDC	1 ad.	97,660 USD.
129 087 000163	IL-XLDB-VT10-220K	LEDLİ DÖNER + BUZZER	TABANA MONTAJ	220VAC	1 ad.	109,020 USD.
<b>L-X...-VT12 SERİSİ Ø 120 İKAZ LAMBALARI</b>						
129 087 000165	IL-XLS-VT12-24K	SABİT İŞIKLI	TABANA MONTAJ	24VDC	1 ad.	90,850 USD.
129 087 000166	IL-XLS-VT12-220K	SABİT İŞIKLI	TABANA MONTAJ	220VAC	1 ad.	102,200 USD.
129 087 000168	IL-XLF-VT12-24K	FLAŞÖRLÜ	TABANA MONTAJ	24VDC	1 ad.	90,850 USD.
129 087 000169	IL-XLF-VT12-220K	FLAŞÖRLÜ	TABANA MONTAJ	220VAC	1 ad.	102,200 USD.
129 087 000171	IL-XÇ-VT12-24K	ÇAKAR	TABANA MONTAJ	24VDC	1 ad.	90,850 USD.
129 087 000172	IL-XÇ-VT12-220K	ÇAKAR	TABANA MONTAJ	220VAC	1 ad.	102,200 USD.
129 087 000175	IL-XLD-VT12-24K	LEDLİ DÖNER	TABANA MONTAJ	24VDC	1 ad.	90,850 USD.
129 087 000176	IL-XLD-VT12-220K	LEDLİ DÖNER	TABANA MONTAJ	220VAC	1 ad.	102,200 USD.
129 087 000178	IL-XLSB-VT12-24K	SABİT İŞIKLI + BUZZER	TABANA MONTAJ	24VDC	1 ad.	90,850 USD.
129 087 000179	IL-XLSB-VT12-220K	SABİT İŞIKLI + BUZZER	TABANA MONTAJ	220VAC	1 ad.	102,200 USD.
129 087 000181	IL-XLFB-VT12-24K	FLAŞÖRLÜ + BUZZER	TABANA MONTAJ	24VDC	1 ad.	105,040 USD.
129 087 000182	IL-XLFB-VT12-220K	FLAŞÖRLÜ + BUZZER	TABANA MONTAJ	220VAC	1 ad.	113,560 USD.
129 087 000184	IL-XÇB-VT12-24K	ÇAKAR + BUZZER	TABANA MONTAJ	24VDC	1 ad.	137,410 USD.
129 087 000185	IL-XÇB-VT12-220K	ÇAKAR + BUZZER	TABANA MONTAJ	220VAC	1 ad.	149,900 USD.
129 087 000187	IL-XLDB-VT12-24K	LEDLİ DÖNER + BUZZER	TABANA MONTAJ	24VDC	1 ad.	111,290 USD.
129 087 000188	IL-XLDB-VT12-220K	LEDLİ DÖNER + BUZZER	TABANA MONTAJ	220VAC	1 ad.	124,910 USD.
RENK SEÇENEKLERİ: IL-XLS-VT10-12K ● IL-XLS-VT10-12S ● IL-XLS-VT10-12Y ● IL-XLS-VT8-12M ● IL-XLS-VT10-12B ○						

**İşikli kolonlarda kırmızı sabit renktir. Diğer renkler siparişe yapılabilmektedir.**

## IL-X...-B ve Q Serisi Standart 85dB Ekonomik Seri İkaz Lambaları

### Genel Özellikler

- Lens PC
- Gövde ABS
- 0...120db Ayarlanabilir Buzzer Sesi
- Led Işık
- 5 Ayrı Renk Seçeneği; Kırmızı, Sarı, Yeşil, Mavi, Beyaz
- 24V DC ve 24V, 220V AC Besleme
- Seçilebilir Farklı Çalışma Modelleri; Sabit, Flaşör, Çakar ve Döner



0...120db  
Ayarlanabilir  
Buzzer Sesi

ÜRÜN KODU	ÇALIŞMA ŞEKLİ	BESLEME GERİLİMİ	Q-MODEL	B-MODEL	FİYAT
-----------	---------------	------------------	---------	---------	-------

### IL-X...-QM Serisi Multi Fonksiyon Ayarlanabilir Sesli İkaz Lambaları

129 087 000400	Tek Katlı	24V DC	IL-XLMB-QH-24X		40,000 USD.
129 087 000402	Tek Katlı	220V AC	IL-XLMB-QH-220X		45,000 USD.
129 087 000404	İki Katlı	24V DC	IL-XLMB-QH-242		50,000 USD.
129 087 000406	İki Katlı	220V AC	IL-XLMB-QH-2202		55,000 USD.
129 087 000408	Üç Katlı	24V DC	IL-XMB-QH-243		60,000 USD.
129 087 000410	Üç Katlı	220V AC	IL-XMB-QH-2203		65,000 USD.

### IL-X...-BM Serisi Multi Fonksiyon Ayarlanabilir Sesli İkaz Lambaları

129 087 000401	Tek Katlı	24V DC		IL-XLMB-BH-24X	40,000 USD.
129 087 000403	Tek Katlı	220V AC		IL-XLMB-BH-220X	45,000 USD.
129 087 000405	İki Katlı	24V DC		IL-XLMB-BH-242	50,000 USD.
129 087 000407	İki Katlı	220V AC		IL-XLMB-BH-2202	55,000 USD.
129 087 000409	Üç Katlı	24V DC		IL-XMB-BH-243	60,000 USD.
129 087 000411	Üç Katlı	220V AC		IL-XMB-BH-2203	65,000 USD.

RENK SEÇENEKLERİ: IL-XLMB-Q-12K ● IL-XLMB-Q-12S ● IL-XLMB-Q-12Y ● IL-XLMB-Q-12M ● IL-XLMB-Q-12B ○

Ürün Kodu	Besleme Gerilimi	Ses dB	Çalışma Şekli	Fiyat	
<b>IL-XB-B SERİSİ Ø 67 BORULU KORNALAR</b>					
129 087 000230	IL-XB-B-24	24V	95dB/30 cm	KESİK KESİK	40,000 USD.
129 087 000233	IL-XB-B-220	220V	95dB/30 cm	KESİK KESİK	40,000 USD.

Ürün Kodu	Besleme Gerilimi	Ses dB	Çalışma Şekli	Fiyat	
<b>IL-XB-Q SERİSİ Ø 67 KÜBİK KORNALAR</b>					
129 087 000235	IL-XB-Q-24	24V	95dB/30 cm	KESİK KESİK	40,000 USD.
129 087 000238	IL-XB-Q-220	220V	95dB/30 cm	KESİK KESİK	40,000 USD.

Ürün Kodu	Besleme Gerilimi	Ses dB	Çalışma Şekli	Kablolu	Fiyat	
<b>IL-XFM SERİSİ BUZZER</b>						
129 087 000245	IL-XFM-12A-905AL70	12V	90dB/30 cm	ÇİFT SES	KABLolu	15,140 USD.
129 087 000246	IL-XFM-12Q-905L70	12V	95dB/60 cm	ÇİFT SES	KABLolu	15,140 USD.
129 087 000247	IL-XFM-24C-905L70	24V	92dB/100 cm	ÇİFT SES	KABLolu	15,140 USD.
129 087 000248	IL-XFM-220A-905AL70	220V	95dB/30 cm	ÇİFT SES	KABLolu	17,850 USD.
129 087 000249	IL-XFM-24C-900L700	24V	92dB/100 cm	SÜREKLİ	KABLolu	15,140 USD.
129 087 000250	IL-XFM-220A-905A	12V	90dB/300 cm	ÇİFT SES	SOKETLİ	17,850 USD.
129 087 000251	IL-XFM-12A-905A	220V	90dB/30 cm	ÇİFT SES	SOKETLİ	15,140 USD.
129 087 000252	IL-XFM-12Q-905	12V	90dB/30 cm	ÇİFT SES	SOKETLİ	15,140 USD.

İşikli kolonlarda kırmızı sabit renktir. Diğer renkler siparişle yapılabilmektedir.



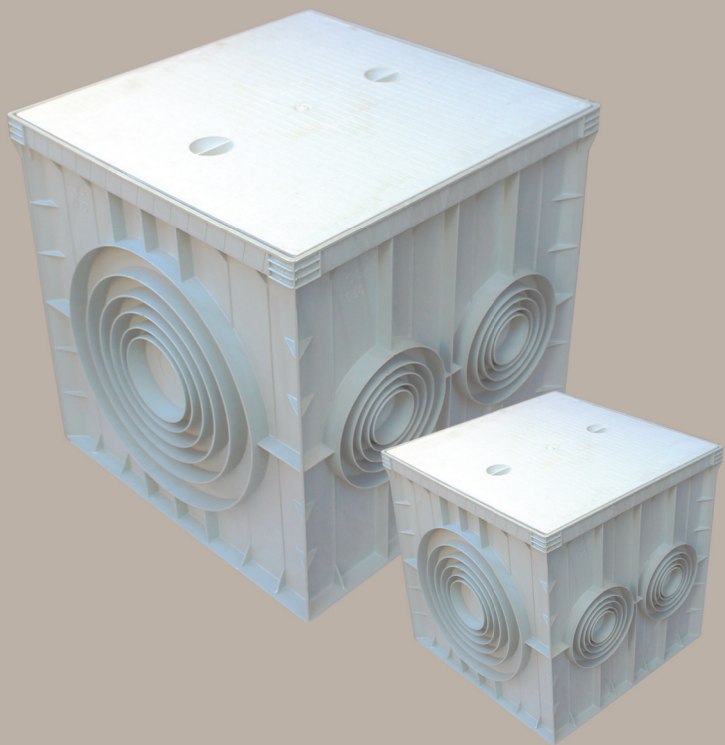

## TERMOPLASTİK BUATLAR ve KOMBİNASYON KUTULARI



**Ürün Kodu** : 001 046 000101 00 00  
**Ürün Adı** : KARE ANTİGRON BUAT  
 85X85  
**Ambalaj Ad.** : 10 ad. / Koli: 300  
**Fiyat** : 1,625 TL



**Ürün Kodu** : 001 046 071210 00 00  
**Ürün Adı** : 125X100X75  
 TERMOPLASTİK BUAT  
**Ambalaj Ad.** : 10 ad. / Koli: 80  
**Fiyat** : 8,933 TL



**Ürün Kodu** : 001 046 078080 00 17  
**Ürün Adı** : 80X80X48  
 TERMO PLASTİK BUAT (7 ÇIKIŞLI)  
**Ambalaj Ad.** : 18 ad. / Koli: 216  
**Fiyat** : 2,025 TL



**Ürün Kodu** : 001 046 071414 00 00  
**Ürün Adı** : 140X140X70  
 TERMOPLASTİK BUAT  
**Ambalaj Ad.** : 10 ad. / Koli: 80  
**Fiyat** : 9,024 TL



**Ürün Kodu** : 001 046 078585 00 17  
**Ürün Adı** : 85X85X48  
 TERMOPLASTİK BUAT  
**Ambalaj Ad.** : 18 ad. / Koli: 216  
**Fiyat** : 1,738 TL



**Ürün Kodu** : 001 046 071827 00 17  
**Ürün Adı** : 180X270X100  
 TERMO PLASTİK BUAT (14 ÇIKIŞLI)  
**Ambalaj Ad.** : 2 ad. / Koli: 20  
**Fiyat** : 15,362 TL



**Ürün Kodu** : 001 046 070090 00 17  
**Ürün Adı** : 90'LİK  
 TERMOPLASTİK BUAT  
**Ambalaj Ad.** : 18 ad. / Koli: 216  
**Fiyat** : 2,129 TL



**Ürün Kodu** : 001 046 073020 00 00  
**Ürün Adı** : 300X200X125  
 TERMOPLASTİK BUAT  
**Ambalaj Ad.** : 1 ad. / Koli: 15  
**Fiyat** : 26,048 TL



**Ürün Kodu** : 001 046 071010 00 17  
**Ürün Adı** : 110X110X74  
 TERMO PLASTİK BUAT (8 ÇIKIŞLI)  
**Ambalaj Ad.** : 10 ad. / Koli: 100  
**Fiyat** : 4,420 TL



**Ürün Kodu** : 001 046 073525 00 00  
**Ürün Adı** : 350X255X125  
 TERMOPLASTİK BUAT  
**Ambalaj Ad.** :  
**Fiyat** : 30,079 TL



**Ürün Kodu** : 001 046 071118 00 17  
**Ürün Adı** : 110X180X77  
 TERMO PLASTİK BUAT (10 ÇIKIŞLI)  
**Ambalaj Ad.** : 5 ad. / Koli: 60  
**Fiyat** : 8,239 TL

## DEVRE KESEN VE NH00 KAİDELER

025 110 00001	TRİFAZE DEVRE KESEN	1	ad.	29,516
025 110 00002	MONOFAZE DEVRE KESEN	2	ad.	16,164
025 110 00003	TEK KOFRA	1	ad.	52,708
025 110 00004	NH00 BOY KAİDE	6	ad.	5,482
025 110 00005	NH00 BOY BIÇAKLI SİG.(25A.-150A.)	10	ad.	6,044
025 110 000025	NH POLYESTER YER ALTI KOFRASI ( KESİCİLİ )	1	ad.	171,721



## TERMOPLASTİK BUATLAR ve KOMBİNASYON KUTULARI



**Ürün Kodu** : 001 046 078226 00 17  
**Ürün Adı** : 138X226X127  
 KOMBİNASYON KUTUSU  
 (SİGORTALI BOŞ)  
**Ambalaj Ad.** : 1 ad. / Koli: 8  
**Fiyat** : 19,069 TL



**Ürün Kodu** : 001 046 075311 00 17  
**Ürün Adı** : 225X311X132  
 KOMBİNASYON KUTUSU  
 (SİGORTALI BOŞ)  
**Ambalaj Ad.** : 1 ad. / Koli: 4  
**Fiyat** : 24,131 TL



**Ürün Kodu** : 001 046 071199 00 17  
**Ürün Adı** : 225X311X99  
 TERMO PLASTİK BUAT  
**Ambalaj Ad.** : 1 ad. / Koli: 4  
**Fiyat** : 18,113 TL



**Ürün Kodu** : 001 046 072698 00 44  
**Ürün Adı** : 138X226X98  
 ŞEFFAF TERMO PLASTİK BUAT  
**Ambalaj Ad.** : 1 ad. / Koli: 8  
**Fiyat** : 16,316 TL

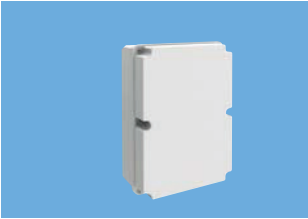

**Ürün Kodu** : 001 046 071130 00 17  
**Ürün Adı** : 225X311X130  
 TERMO PLASTİK BUAT  
**Ambalaj Ad.** : 1 ad. / Koli: 4  
**Fiyat** : 23,719 TL



**Ürün Kodu** : 001 046 076131 00 44  
**Ürün Adı** : 138X226X131  
 ŞEFFAF TERMO PLASTİK BUAT  
**Ambalaj Ad.** : 1 ad. / Koli: 8  
**Fiyat** : 17,041 TL



**Ürün Kodu** : 001 046 072698 00 17  
**Ürün Adı** : 138X226X98  
 TERMO PLASTİK BUAT  
**Ambalaj Ad.** : 1 ad. / Koli: 8  
**Fiyat** : 14,864 TL

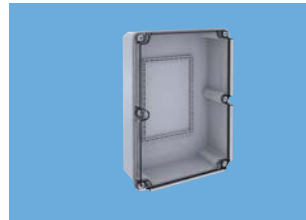

**Ürün Kodu** : 001 046 071199 00 44  
**Ürün Adı** : 225X311X99  
 ŞEFFAF TERMO PLASTİK BUAT  
**Ambalaj Ad.** : 1 ad. / Koli: 4  
**Fiyat** : 19,808 TL



**Ürün Kodu** : 001 046 076131 00 17  
**Ürün Adı** : 138X226X131  
 TERMO PLASTİK BUAT  
**Ambalaj Ad.** : 1 ad. / Koli: 8  
**Fiyat** : 15,813 TL

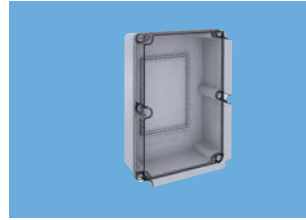

**Ürün Kodu** : 001 046 071130 00 44  
**Ürün Adı** : 225X311X130  
 ŞEFFAF TERMO PLASTİK BUAT  
**Ambalaj Ad.** : 1 ad. / Koli: 4  
**Fiyat** : 24,668 TL

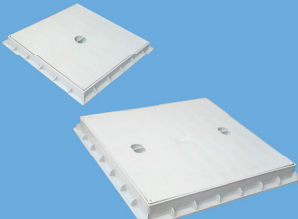

## PLASTİK LOGAR KAPAK+ÇERÇEVE

074 048 612020	20X20 LOGAR KAPAK+ÇERÇEVE	1	ad.	9,327
074 048 613030	30X30 LOGAR KAPAK+ÇERÇEVE	1	ad.	18,018
074 048 613535	35X35 LOGAR KAPAK+ÇERÇEVE	1	ad.	26,541
074 048 614040	40X40 LOGAR KAPAK+ÇERÇEVE	1	ad.	29,726
074 048 615050	50X50 LOGAR KAPAK+ÇERÇEVE	1	ad.	69,159
074 048 615555	55X55 LOGAR KAPAK+ÇERÇEVE	1	ad.	120,574



## LOGAR KUTUSU

074 048 622020	20X20 LOGAR KUTUSU TAKIM	1	ad.	19,273
074 048 623030	30X30 LOGAR KUTUSU TAKIM	1	ad.	38,599
074 048 623535	35X35 LOGAR KUTUSU TAKIM	1	ad.	48,533
074 048 624040	40X40 LOGAR KUTUSU TAKIM	1	ad.	66,733
074 048 625050	50X50 LOGAR KUTUSU TAKIM	1	ad.	151,665
074 048 625555	55X55 LOGAR KUTUSU TAKIM	1	ad.	227,498



## ALEV YAYMAYAN TERMOPLASTİK BUATLAR VE KOMBİNASYON KUTULARI



**Ürün Kodu** : 001 046 098080 00 17  
**Ürün Adı** : TERMOPLASTİK BUAT 80X80X48  
 (7ÇIKIŞLI)(A. YAYMAYAN)  
**Ambalaj Ad.** : 18 ad. / Koli: 216  
**Fiyat** : 2,665 TL



**Ürün Kodu** : 001 046 098585 00 17  
**Ürün Adı** : TERMOPLASTİK BUAT 85X85X48  
 (A. YAYMAYAN)  
**Ambalaj Ad.** : 18 ad. / Koli: 216  
**Fiyat** : 2,232 TL



**Ürün Kodu** : 001 046 090090 00 17  
**Ürün Adı** : TERMOPLASTİK BUAT 90'lık  
 (A. YAYMAYAN)  
**Ambalaj Ad.** : 18 ad. / Koli: 216  
**Fiyat** : 2,874 TL



**Ürün Kodu** : 001 046 091010 00 17  
**Ürün Adı** : TERMOPLASTİK BUAT 110X110X74  
 (8 ÇIKIŞLI)(A.YAYMAYAN)  
**Ambalaj Ad.** : 10 ad. / Koli: 100  
**Fiyat** : 7,925 TL



**Ürün Kodu** : 001 046 091118 00 17  
**Ürün Adı** : TERMOPLASTİK BUAT 110X180X77  
 (10 ÇIKIŞLI)(GRİ) (A. YAYMAYAN)  
**Ambalaj Ad.** : 5 ad. / Koli: 60  
**Fiyat** : 12,029 TL



**Ürün Kodu** : 001 046 091827 00 17  
**Ürün Adı** : TERMO PLASTİK BUAT 180X270X100  
 (14ÇIKIŞLI)(GRİ) (A. YAYMAYAN)  
**Ambalaj Ad.** : 2 ad. / Koli: 20  
**Fiyat** : 31,420 TL



**Ürün Kodu** : 001 046 098226 00 17  
**Ürün Adı** : 138X226X127 KOMBİNASYON KUTUSU  
 (A. YAYMAYAN)(SİGORTALI BOŞ)  
**Ambalaj Ad.** : 1 ad. / Koli: 8  
**Fiyat** : 26,741 TL



**Ürün Kodu** : 001 046 095311 00 17  
**Ürün Adı** : 225X311X132 KOMBİNASYON KUTUSU  
 (A. YAYMAYAN)(SİGORTALI BOŞ)  
**Ambalaj Ad.** : 1 ad. / Koli: 4  
**Fiyat** : 34,309 TL



**Ürün Kodu** : 001 046 091199 00 17  
**Ürün Adı** : TERMO PLASTİK BUAT 225X311X99  
 (A. YAYMAYAN)  
**Ambalaj Ad.** : 1 ad. / Koli: 4  
**Fiyat** : 27,048 TL



**Ürün Kodu** : 001 046 091130 00 17  
**Ürün Adı** : TERMOPLASTİK BUAT 225X311X130  
 (A. YAYMAYAN)  
**Ambalaj Ad.** : 1 ad. / Koli: 4  
**Fiyat** : 33,413 TL



**Ürün Kodu** : 001 046 092698 00 17  
**Ürün Adı** : TERMO PLASTİK BUAT 138X226X98  
 (A. YAYMAYAN)  
**Ambalaj Ad.** : 1 ad. / Koli: 8  
**Fiyat** : 20,939 TL



**Ürün Kodu** : 001 046 096131 00 17  
**Ürün Adı** : TERMO PLASTİK BUAT 138X226X131  
 (A. YAYMAYAN)  
**Ambalaj Ad.** : 1 ad. / Koli: 8  
**Fiyat** : 22,275 TL



**Ürün Kodu** : 001 046 092698 00 44  
**Ürün Adı** : TERMO PLASTİK BUAT 138X226X98  
 (ŞEFFAF) (A. YAYMAYAN)  
**Ambalaj Ad.** : 1 ad. / Koli: 8  
**Fiyat** : 21,145 TL



**Ürün Kodu** : 001 046 096131 00 44  
**Ürün Adı** : TERMO PLASTİK BUAT 138X226X131  
 (ŞEFFAF) (A. YAYMAYAN)  
**Ambalaj Ad.** : 1 ad. / Koli: 8  
**Fiyat** : 23,100 TL

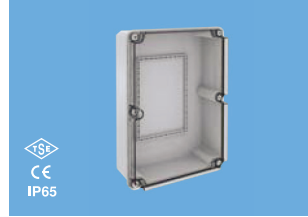

**Ürün Kodu** : 001 046 091199 00 44  
**Ürün Adı** : TERMO PLASTİK BUAT 225X311X99  
 (ŞEFFAF)(A. YAYMAYAN)  
**Ambalaj Ad.** : 1 ad. / Koli: 4  
**Fiyat** : 27,562 TL

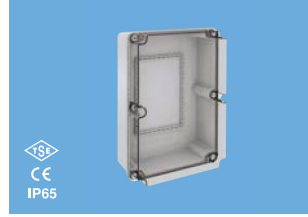

**Ürün Kodu** : 001 046 091130 00 44  
**Ürün Adı** : TERMO PLASTİK BUAT 225X311X130  
 (A. YAYMAYAN)  
**Ambalaj Ad.** : 1 ad. / Koli: 4  
**Fiyat** : 33,170 TL



Ürün Kodu	Açıklama / Stok Cinsi	Ambalaj (Kutu/Bağ)	Ambalaj (Koli/Çuval)	TL
<b>PANO FİLTRESİ</b>				
054 126 020002	120X120 PANO FİLTRESİ	1 ad.		6,353
<b>PLASTİK OPAK KAPAKLI PANOLARI</b>				
048 090 203013	20X30X13 PLASTİK OPAK KAPAKLI PANO	1 ad.		45,375
048 090 253515	25X35X15 PLASTİK OPAK KAPAKLI PANO	1 ad.		48,400
048 090 304017	30X40X17 PLASTİK OPAK KAPAKLI PANO	1 ad.		68,819
048 090 304022	30X40X22 PLASTİK OPAK KAPAKLI PANO	1 ad.		81,524
048 090 355019	35X50X19 PLASTİK OPAK KAPAKLI PANO	1 ad.		98,464
048 090 405018	40X50X17,5 PLASTİK OPAK KAPAKLI PANO	1 ad.		108,826
048 090 405024	40X50X24 PLASTİK OPAK KAPAKLI PANO	1 ad.		116,463
048 090 406020	40X60X20 PLASTİK OPAK KAPAKLI PANO	1 ad.		121,756
048 090 507025	50X70X25 PLASTİK OPAK KAPAKLI PANO	1 ad.		238,219
048 090 608026	60X80X26 PLASTİK OPAK KAPAKLI PANO	1 ad.		359,9964
<b>PLASTİK ŞEFFAF KAPAKLI PANOLARI</b>				
048 088 203013	20X30X13 PLASTİK ŞEFFAF KAPAKLI PANO	1 ad.		57,173
048 088 253515	25X35X15 PLASTİK ŞEFFAF KAPAKLI PANO	1 ad.		63,525
048 088 304017	30X40X17 PLASTİK ŞEFFAF KAPAKLI PANO	1 ad.		80,465
048 088 304022	30X40X22 PLASTİK ŞEFFAF KAPAKLI PANO	1 ad.		88,935
048 088 355019	35X50X19 PLASTİK ŞEFFAF KAPAKLI PANO	1 ad.		112,228
048 088 405018	40X50X17,5 PLASTİK ŞEFFAF KAPAKLI PANO	1 ad.		141,873
048 088 405024	40X50X24 PLASTİK ŞEFFAF KAPAKLI PANO	1 ad.		146,108
048 088 406020	40X60X20 PLASTİK ŞEFFAF KAPAKLI PANO	1 ad.		148,225
048 088 507025	50X70X25 PLASTİK ŞEFFAF KAPAKLI PANO	1 ad.		319,743
048 088 608026	60X80X26 PLASTİK ŞEFFAF KAPAKLI PANO	1 ad.		453,3288
<b>OTOMATİK DAĞITIM PANOLARI</b>				
048 086 253515	25X35X15 OTOMATİK DAĞITIM PANOSU (2X9) OPAK	1 ad.		81,524
048 086 304017	30X40X17 OTOMATİK DAĞITIM PANOSU (2X12) OPAK	1 ad.		103,758
048 086 355019	35X50X19 OTOMATİK DAĞITIM PANOSU (15X3) OPAK	1 ad.		151,401
048 086 406020	40X60X20 OTOMATİK DAĞITIM PANOSU (15X4) OPAK	1 ad.		183,164
048 087 253515	25X35X15 OTOMATİK DAĞITIM PANOSU (2X9) ŞEFFAF	1 ad.		97,405
048 087 304017	30X40X17 OTOMATİK DAĞITIM PANOSU (2X12) ŞEFFAF	1 ad.		114,345
048 087 355019	35X50X19 OTOMATİK DAĞITIM PANOSU (15X3) ŞEFFAF	1 ad.		176,811
048 087 406020	40X60X20 OTOMATİK DAĞITIM PANOSU (15X4) ŞEFFAF	1 ad.		206,456
<b>POLYESTER ETANJ PANOLAR (POSEL)</b>				
009 089 001510	S/A TEKLİ SAYAÇ PANOSU MONOFAZE	1 ad.	20	46,856
009 089 152011	15X20X11 POLY. ETANJ PANO	1 ad.	12	35,560
009 089 162610	16X26X10 POLY. ETANJ PANO	1 ad.	20	34,014
009 089 202517	20X25X17 POLY. ETANJ PANO	1 ad.	10	52,567
009 089 202512	20X25X12 POLY. ETANJ PANO	1 ad.	12	52,567
009 089 203017	30X20X17 POLY. ETANJ PANO	1 ad.	8	54,326
009 089 203012	30X20X12 POLY. ETANJ PANO	1 ad.	12	54,326
009 089 253017	25X30X17 POLY. ETANJ PANO	1 ad.	6	60,900
009 089 253012	25X30X12 POLY. ETANJ PANO	1 ad.	6	60,298
009 089 304017	30X40X17 POLY. ETANJ PANO	1 ad.	4	79,566
009 089 304012	30X40X12 POLY. ETANJ PANO	1 ad.	5	79,566
009 089 355022	35X50X22 POLY. ETANJ PANO	1 ad.	3	114,450
009 089 355017	35X50X17 POLY. ETANJ PANO	1 ad.	3	114,450
009 089 406022	40X60X22 POLY. ETANJ PANO	1 ad.	3	123,680
009 089 406017	40X60X17 POLY. ETANJ PANO	1 ad.	3	123,680
009 089 406027	40X60X27 POLY. ETANJ PANO	1 ad.	2	173,556
009 089 508032	50X80X32 POLY. ETANJ PANO	1 ad.	1	309,750
009 089 701001	70X100X33 POLY. ETANJ PANO (TEK KAPI)	1 ad.	1	1.159,572
009 089 701002	70X100X33 POLY. ETANJ PANO (ÇİFT KAPI)	1 ad.	1	1.258,950
<b>PLASTİK OPAK PANOLAR</b>				
048 089 212813	21X28X13 PLASTİK OPAK PANO	1 ad.		53,848
048 089 253313	25X33X13 PLASTİK OPAK PANO	1 ad.		58,364
048 089 304017	30X40X16,5 PLASTİK OPAK PANO	1 ad.		81,641
048 089 405018	40X50X17,5 PLASTİK OPAK PANO	1 ad.		121,593
048 089 406020	40X60X20 PLASTİK OPAK PANO	1 ad.		152,859
048 089 507025	50X70X24,5 PLASTİK OPAK PANO	1 ad.		281,400
048 089 355020	35X50X19,5 PLASTİK OPAK PANO	1 ad.		121,593



## MUTLUSAN SANAYİ FİŞ-PRİZ GRUBU (MONOFAZE 1X16 A.)



**Ürün Kodu** : 010 083 300027  
**Ürün Adı** : MUT-27 1X16 A. MONO.  
 TOP. ERKEK FİŞ(EĞİK)  
**Ambalaj Ad.** : 50 ad. / Koli: 400  
**Fiyat** : 3,430 TL



**Ürün Kodu** : 010 083 500293  
**Ürün Adı** : MUT-293 1X16 A. MONO.  
 3'LÜ GRUP PRİZ  
**Ambalaj Ad.** : 12 ad. / Koli: 96  
**Fiyat** : 12,430 TL

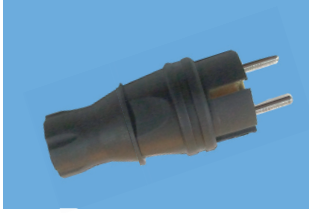

**Ürün Kodu** : 010 083 300028  
**Ürün Adı** : MUT-28 1X16 A. MONO.TOP.  
 ERKEK FİŞ(DÜZ)  
**Ambalaj Ad.** : 50 ad. / Koli: 400  
**Fiyat** : 3,430 TL



**Ürün Kodu** : 010 083 501293  
**Ürün Adı** : MUT-293A 1X16 A.  
 MONO.3'LÜ GR.PRİZ ANH.  
**Ambalaj Ad.** : 10 ad. / Koli: 80  
**Fiyat** : 19,678 TL



**Ürün Kodu** : 010 083 300029  
**Ürün Adı** : MUT-29 1X16 A. MONO.  
 TOPOPRAKLI DIŞI FİŞ  
**Ambalaj Ad.** : 30 ad. / Koli: 240  
**Fiyat** : 5,313 TL



**Ürün Kodu** : 010 083 500298  
**Ürün Adı** : MUT-298 MONOFAZE  
 TOPRAKLI PANO PRİZİ  
**Ambalaj Ad.** : 40 ad. / Koli: 320  
**Fiyat** : 3,663 TL



**Ürün Kodu** : 010 083 500296  
**Ürün Adı** : MUT-296 1X16 A. MONO.  
 TOP. DUVAR PRİZİ  
**Ambalaj Ad.** : 20 ad. / Koli: 160  
**Fiyat** : 9,277 TL

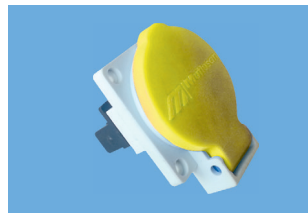

**Ürün Kodu** : 010 083 501297  
**Ürün Adı** : MUT-298-U MONO. UPS  
 TOPRAKLI PANO PRİZİ  
**Ambalaj Ad.** : 30 ad. / Koli: 240  
**Fiyat** : 6,085 TL



**Ürün Kodu** : 010 083 500292  
**Ürün Adı** : MUT-292 1X16 A. MONO.  
 2'Lİ GRUP PRİZ  
**Ambalaj Ad.** : 12 ad. / Koli: 96  
**Fiyat** : 11,666 TL



**Ürün Kodu** : 010 083 500297  
**Ürün Adı** : MUT-297 MONO. DUVAR  
 PRİZİ (PLASTİK)  
**Ambalaj Ad.** : 30 ad. / Koli: 240  
**Fiyat** : 6,540 TL



**Ürün Kodu** : 010 083 501292  
**Ürün Adı** : MUT-292A 1X16 A. MONO.  
 2'Lİ GRUP PRİZ ANH.  
**Ambalaj Ad.** : 12 ad. / Koli: 96  
**Fiyat** : 17,991 TL

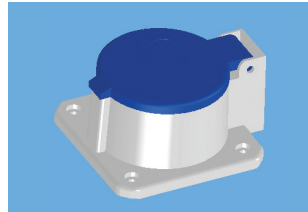

**Ürün Kodu** : 010 083 500299  
**Ürün Adı** : MUT-299 MONO. MAKİNA  
 PRİZİ  
**Ambalaj Ad.** : 20 ad. / Koli: 160  
**Fiyat** : 8,175 TL

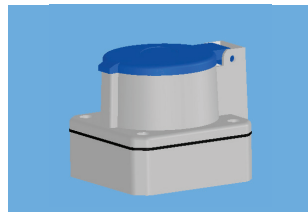

**Ürün Kodu** : 010 083 502910  
**Ürün Adı** : MUT-2910 MONO. DUVAR  
 PRİZİ  
**Ambalaj Ad.** : 15 ad. / Koli: 120  
**Fiyat** : 9,024 TL

**MUTLUSAN SANAYİ FİŞ-PRİZ GRUBU (TRİFAZE 3X16 A.)**

**Ürün Kodu** : 010 083 400060  
**Ürün Adı** : MUT-60 3X16 TRİFAZE ERKEK FİŞ  
**Ambalaj Ad.** : 30 ad. / Koli: 240  
**Fiyat** : 8,264 TL



**Ürün Kodu** : 010 083 400061  
**Ürün Adı** : MUT-61 3X16 TRİFAZE SEYYAR DIŞI FİŞ  
**Ambalaj Ad.** : 25 ad. / Koli: 200  
**Fiyat** : 11,642 TL



**Ürün Kodu** : 010 083 400062  
**Ürün Adı** : MUT-62 3X16 TRİFAZE DUVAR PRİZ  
**Ambalaj Ad.** : 20 ad. / Koli: 160  
**Fiyat** : 14,365 TL

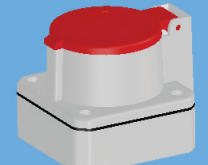

**Ürün Kodu** : 010 083 400063  
**Ürün Adı** : MUT-63 3X16 TRİFAZE DUVAR PRİZ (PLS)  
**Ambalaj Ad.** : 12 ad. / Koli: 96  
**Fiyat** : 12,309 TL

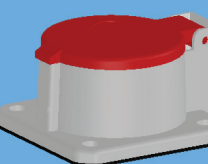

**Ürün Kodu** : 010 083 400064  
**Ürün Adı** : MUT-64 3X16 TRİFAZE MAKİNA PRİZ (PLS)  
**Ambalaj Ad.** : 20 ad. / Koli: 160  
**Fiyat** : 9,133 TL

**MUTLUSAN SANAYİ FİŞ-PRİZ GRUBU (TRİFAZE 3X25 A.)**

**Ürün Kodu** : 010 083 400030  
**Ürün Adı** : MUT-30 3X25 TRİFAZE ERKEK FİŞ  
**Ambalaj Ad.** : 30 ad. / Koli: 240  
**Fiyat** : 5,482 TL



**Ürün Kodu** : 010 083 400031  
**Ürün Adı** : MUT-31 3X25 TRİFAZE DIŞI FİŞ (SEYYAR)  
**Ambalaj Ad.** : 20 ad. / Koli: 160  
**Fiyat** : 9,136 TL

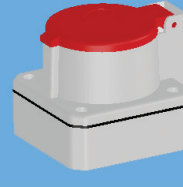

**Ürün Kodu** : 010 083 600315  
**Ürün Adı** : MUT-315 3X25 TRİFAZE DUVAR PRİZ  
**Ambalaj Ad.** : 20 ad. / Koli: 160  
**Fiyat** : 12,0310 TL

**MUTLUSAN SANAYİ FİŞ-PRİZ GRUBU (TRİFAZE 3X25 A.)**

**Ürün Kodu** : 010 083 400319  
**Ürün Adı** : MUT-319 3X25 TRİFAZE DUVAR PRİZİ (PLS)  
**Ambalaj Ad.** : 15 ad. / Koli: 120  
**Fiyat** : 10,959 TL

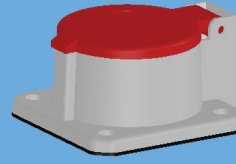

**Ürün Kodu** : 010 083 400318  
**Ürün Adı** : MUT-318 3X25 TRİFAZE MAKİNA PRİZİ (PLS)  
**Ambalaj Ad.** : 20 ad. / Koli: 160  
**Fiyat** : 9,829 TL



**Ürün Kodu** : 010 083 600311  
**Ürün Adı** : MUT-311 1 TRİFAZE 1 MONOFAZE GRUP PRİZ  
**Ambalaj Ad.** : 10 ad. / Koli: 80  
**Fiyat** : 20,271 TL



**Ürün Kodu** : 010 083 600312  
**Ürün Adı** : MUT-312 TRİFAZE 2'Lİ GRUP PRİZ  
**Ambalaj Ad.** : 10 ad. / Koli: 80  
**Fiyat** : 23,894 TL

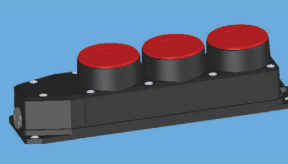

**Ürün Kodu** : 010 083 600313  
**Ürün Adı** : MUT-313 TRİFAZE 3'Lİ GRUP PRİZ  
**Ambalaj Ad.** : 10 ad. / Koli: 80  
**Fiyat** : 30,922 TL

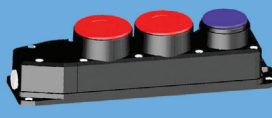

**Ürün Kodu** : 010 083 600316  
**Ürün Adı** : MUT-316 2 TRİFAZE 1 MONOFAZE GRUP PRİZ  
**Ambalaj Ad.** : 10 ad. / Koli: 80  
**Fiyat** : 28,111 TL

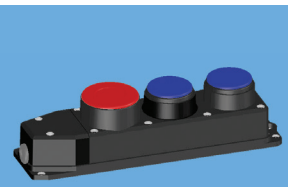

**Ürün Kodu** : 010 083 600317  
**Ürün Adı** : MUT-317 1 TRİFAZE 2 MONOFAZE GRUP PRİZ  
**Ambalaj Ad.** : 8 ad. / Koli: 64  
**Fiyat** : 27,027 TL

## SANAYİ FİŞ - PRİZ GRUBU (TRİFAZE 3X32 A.)



Ürün Kodu : 010 083 400070  
 Ürün Adı : MUT-70 3X32 TRİFAZE  
 ERKEK FİŞ  
 Ambalaj Ad. : 20 ad. / Koli: 160  
 Fiyat : 12,994 TL



Ürün Kodu : 010 083 400071  
 Ürün Adı : MUT-71 3X32 TRİFAZE  
 SEYYAR DIŞI FİŞ  
 Ambalaj Ad. : 20 ad. / Koli: 160  
 Fiyat : 15,385 TL

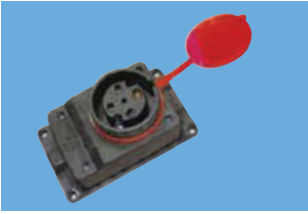

Ürün Kodu : 010 083 400072  
 Ürün Adı : MUT-72 3X32 TRİFAZE  
 DUVAR PRİZİ  
 Ambalaj Ad. : 20 ad. / Koli: 160  
 Fiyat : 19,115 TL

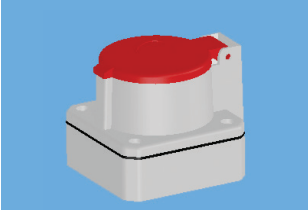

Ürün Kodu : 010 083 400073  
 Ürün Adı : MUT-73 3X32 TRİFAZE  
 DUVAR PRİZİ (PLS)  
 Ambalaj Ad. : 12 ad. / Koli: 96  
 Fiyat : 14,337 TL

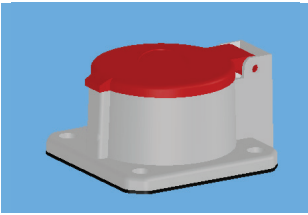

Ürün Kodu : 010 083 400074  
 Ürün Adı : MUT-74 3X32 TRİFAZE  
 MAKİNA PRİZİ (PLS)  
 Ambalaj Ad. : 20 ad. / Koli: 160  
 Fiyat : 10,682 TL

## AKSESUARLAR FİŞ-PRİZ SERİSİ



Ürün Kodu : 005 083 000006  
 Ürün Adı : KOD-18  
 BEŞLİ FİŞ  
 Ambalaj Ad. : 50  
 Fiyat : 2,284 TL



Ürün Kodu : 005 083 000003  
 Ürün Adı : KOD-19 ÜÇLÜ FİŞ  
 (YENİ TİP)  
 Ambalaj Ad. : 50  
 Fiyat : 2,585TL



Ürün Kodu : 005 083 104050  
 Ürün Adı : KOD-4050 ÇOK AMAÇL  
 4'LÜ FİŞ-PRİZ  
 Ambalaj Ad. : 14  
 Fiyat : 9,592 TL

## 8'li - 10'lu GRUP PRİZLER

Açıklama / Stok Cinsi

Ambalaj  
(Kutulu)Ambalaj  
Birimi

TL

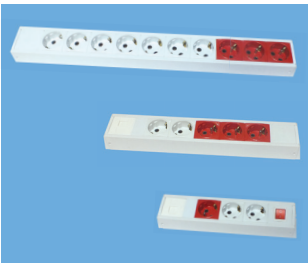

049 122 000002	8 LI KLEMENSLİ GRUP PRİZ	9	ad.	30,922
049 122 000003	10 LU KLEMENSLİ GRUP PRİZ	9	ad.	36,544
049 122 000005	8 LI KLEMENSLİ GRUP PRİZ ANAHTARLI	9	ad.	35,139
049 122 000004	10 LU KLEMENSLİ GRUP PRİZ ANAHTARLI	9	ad.	40,761
049 122 010001	8 LI 2MT GRUP PRİZ	6	ad.	42,166
049 122 010004	8 LI 2MT GRUP PRİZ ANAHTARLI	6	ad.	46,383
049 122 010002	10 LU 2MT GRUP PRİZ	6	ad.	47,788
049 122 010003	10 LU 2MT GRUP PRİZ ANAHTARLI	6	ad.	52,005



Ürün Kodu	Açıklama / Stok Cinsi	Ambalaj (Kutu/Bağ)	Ambalaj (Koli/Çuval)	TL
<b>SEYYAR EL LAMBALARI (TEL KAFESLİ)</b>				
005 084 700003	BALADOZ PLASTİK SAPLI (DUYSUZ-ANAHT.SIZ)	1 ad.	25	9,614
005 084 700009	BALADOZ PLASTİK SAPLI (DUYLU-ANAHT.SIZ)	1 ad.	25	12,369
005 084 700004	BALADOZ PLASTİK SAPLI (PORS.DUYLU-ANHT.)	1 ad.	25	14,477
005 084 700013	BALADOZ KAÜÇÜK SAPLI (DUYLU-ANHT.SIZ)	1 ad.	25	15,461
005 084 700006	BALADOZ PLASTİK SAPLI (PORS.DUYLU-ANHT.) 5 MT	1 ad.	15	22,882
005 084 700007	BALADOZ PLASTİK SAPLI (PORS.DUYLU-ANHT.) 10 MT	1 ad.	12	29,010
005 084 700010	BALADOZ PLASTİK SAPLI (PORS.DUYLU-ANHT.) 15 MT	1 ad.	10	37,247
005 084 700011	BALADOZ PLASTİK SAPLI (PORS.DUYLU-ANHT.) 20 MT	1 ad.	8	44,584
005 084 700012	BALADOZ PLASTİK SAPLI (PORS.DUYLU-ANHT.) 25 MT	1 ad.	8	51,358
005 084 700008	BALADOZ PLASTİK SAPLI PORS.DUYLU-ANHT (PLS CAMLI)	1 ad.	25	32,327



<b>KABLO MAKARALARI (PLASTİK GÖVDE)</b>				
005 083 700045	KOD-45 MONOFAZE PLASTİK BOŞ MAKARA	1 ad.	4	35,139
005 083 700046	KOD-46 TRİFAZE PLASTİK BOŞ MAKARA	1 ad.	4	53,411
120 085 000025	MONOFAZE 3X1,5 KABLÖLÜ MAKARA 25 MT	1 ad.	4	123,688
120 085 000035	MONOFAZE 3X1,5 KABLÖLÜ MAKARA 35 MT	1 ad.	4	157,421
120 085 000050	MONOFAZE 3X1,5 KABLÖLÜ MAKARA 50 MT	1 ad.	4	210,831



<b>ÇANTALI MAKARALAR</b>				
049 122 020012	4 MONO.PRİZ ÇIKIŞLI (20 mt.3X1,5 ) ÇANTALI MAKARA	1 ad.	4	75,900
049 122 020013	4 MONO.PRİZ ÇIKIŞLI (35 mt.3X1,5 ) ÇANTALI MAKARA	1 ad.	4	110,688
049 122 020014	4 MONO.PRİZ ÇIKIŞLI (50 mt.3X1,5 ) ÇANTALI MAKARA	1 ad.	4	132,825
049 122 020015	4 MONO.PRİZ ÇIKIŞLI (20 mt.3X2,5 ) ÇANTALI MAKARA	1 ad.	4	101,200
049 122 020016	4 MONO.PRİZ ÇIKIŞLI (30 mt.3X2,5 ) ÇANTALI MAKARA	1 ad.	4	132,825
049 122 020017	4 MONO.PRİZ ÇIKIŞLI (40 mt.3X2,5 ) ÇANTALI MAKARA	1 ad.	4	164,450



<b>SINTAŞ SANAYİ TİPİ FİŞ PRİZLER</b>				
019 107 016250	16X25 A.4 KUTUPLU FİŞ-PRİZ	1 ad.	30	28,309
019 107 016252	16X25 A.4 KUTUPLU PRİZ	1 ad.	45	16,824
019 107 016251	16X25 A.4 KUTUPLU FİŞ	1 ad.	60	11,531
019 107 025400	25x40 A.4 KUTUPLU FİŞ-PRİZ	1 ad.	15	49,610
019 107 025402	25x40 A.4 KUTUPLU PRİZ	1 ad.	25	27,174
019 107 025401	25x40 A.4 KUTUPLU FİŞ	1 ad.	35	21,141
019 107 040630	40X63 A.4 KUTUPLU FİŞ-PRİZ	1 ad.	10	70,287
019 107 040632	40X63 A.4 KUTUPLU PRİZ	1 ad.	15	36,920
019 107 040631	40X63 A.4 KUTUPLU FİŞ	1 ad.	25	33,480
019 107 063100	63X100 A.4 KUTUPLU FİŞ-PRİZ	1 ad.	5	121,081
019 107 063102	63X100 A.4 KUTUPLU PRİZ	1 ad.	10	63,394
019 107 063101	63X100 A.4 KUTUPLU FİŞ	1 ad.	15	58,018



<b>SINTAŞ SANAYİ TİPİ SEYYAR PRİZLER</b>				
019 107 016253	16X25 A.4 KUTUPLU SEYYAR PRİZ	1 ad.	45	16,824
019 107 025403	25x40 A.4 KUTUPLU SEYYAR PRİZ	1 ad.	25	27,174
019 107 040633	40X63 A.4 KUTUPLU SEYYAR PRİZ	1 ad.	15	36,920
019 107 063103	63X100 A.4 KUTUPLU SEYYAR PRİZ	1 ad.	10	63,394

## TRİFAZE FİŞ-PRİZ



Ürün Kodu : 041 116 000002

Ürün Adı : TRİFAZE PRİZ

Ambalaj Ad. : 20

Fiyat : 8,470 TL



Ürün Kodu : 041 116 000001

Ürün Adı : TRİFAZE FİŞ

Ambalaj Ad. : 12

Fiyat : 8,319 TL



Ürün Kodu	Açıklama / Stok Cinsi	Ambalaj (Kutulu)	Ambalaj Birimi	TL
<b>0,6-1 KV BAKIR İLETKENLER İÇİN REÇİNELİ EK MUFLAR (AYNI KESİTLERDE ALÜMİNYUM MEVCUTTUR.)</b>				
052 125 010021	E1 415-E1 425 (4X1,5-4X2,5)	1	ad.	32,107
052 125 010019	E1 404-E1 406 (4X4-4X6)	1	ad.	32,107
052 125 010044	E1 515-E1 525 (5X1,5-5X2,5)	1	ad.	35,485
052 125 010045	E1 504-E1 506 (5X4-5X6)	1	ad.	35,485
052 125 010046	E1 715-E1 725 (7X1,5-7X2,5)	1	ad.	54,861
052 125 010020	E1 410 (4X10)	1	ad.	49,906
052 125 010022	E1 416 (4X16)	1	ad.	50,952
052 125 010033	E1 31610 (3X16+10)	1	ad.	50,492
052 125 010034	E1 32516 (3X25+16)	1	ad.	53,186
052 125 010035	E1 33516 (3X35+16)	1	ad.	55,838
052 125 010036	E1 35025 (3X50+25)	1	ad.	58,142
052 125 010047	E1 425 (4X25)	1	ad.	54,303
052 125 010048	E1 435 (4X35)	1	ad.	56,983
052 125 010049	E1 450 (4X50)	1	ad.	59,161
052 125 010051	E1 510-E1 516 (5X10-5X16)	1	ad.	52,899
052 125 010009	E1 215-E1 204 (2X1,5-2X4)	1	ad.	29,804
052 125 010007	E1 206 (2X6)	1	ad.	29,804
052 125 010008	E1 210 (2X10)	1	ad.	47,672
052 125 010010	E1 216-E1 225 (2X16-2X25)	1	ad.	47,672
052 125 010011	E1 235-E1 250 (2X35-2X50)	1	ad.	53,186
052 125 010012	E1 270-E1 295 (2X70-2X95)	1	ad.	71,752
052 125 010027	E1 2120-E1 2150 (2X120-2X150)	1	ad.	127,451
052 125 010028	E1 2185 (2X185)	1	ad.	132,895
052 125 010029	E1 2240 (2X240)	1	ad.	144,482
052 125 010052	E1 115-E1 104 (1X1,5-1X4)	1	ad.	29,315
052 125 010001	E1 106 (1X6)	1	ad.	29,315
052 125 010002	E1 110 (1X10)	1	ad.	34,620
052 125 010004	E1 116-E1 125 (1X16-1X25)	1	ad.	34,620
052 125 010005	E1 135-E1 150 (1X35-1X50)	1	ad.	37,272
052 125 010006	E1 170-E1 195 (1X70-1X95)	1	ad.	39,855
052 125 010024	E1 1120-E1 1150 (1X120-1X150)	1	ad.	53,186
052 125 010025	E1 1185 (1X185)	1	ad.	66,448
052 125 010026	E1 1240 (1X240)	1	ad.	68,681
052 125 010015	E1 315-E1 304 (3X1,5-3X4)	1	ad.	30,990
052 125 010013	E1 306 (3X6)	1	ad.	30,990
052 125 010014	E1 310 (3X10)	1	ad.	47,881
052 125 010016	E1 316 (3X16)	1	ad.	49,208
052 125 010053	E1 325 (3X25)	1	ad.	50,464
052 125 010017	E1 335 (3X35)	1	ad.	53,186
052 125 010050	E1 350 (3X50)	1	ad.	54,861
052 125 010037	E1 37035 (3X70+35)	1	ad.	93,041
052 125 010038	E1 39550 (3X95+50)	1	ad.	97,438
052 125 010054	E1 470 (4X70)	1	ad.	95,833
052 125 010055	E1 495 (4X95)	1	ad.	99,671
052 125 010039	E1 31207 (3X120+70)	1	ad.	155,091
052 125 010040	E1 31507 (3X150+70)	1	ad.	162,280
052 125 010056	E1 4120 (4X120)	1	ad.	161,722
052 125 010057	E1 4150 (4X150)	1	ad.	168,353
052 125 010041	E1 31859 (3X185+95)	1	ad.	239,267
052 125 010042	E1 32401 (3X240+120)	1	ad.	250,365
052 125 010058	E1 4185 (4X185)	1	ad.	245,898
052 125 010059	E1 4240 (4X240)	1	ad.	256,996

Ürün Kodu	Açıklama / Stok Cinsi	Ambalaj (Kutulu)	Ambalaj Birimi	TL
<b>PROTOLİN (REÇİNE)</b>				
052 125 030200	PRO 210 GR. PROTOLİN REÇİNE	1	ad.	11,098
052 125 030300	PRO 300 GR. PROTOLİN REÇİNE	1	ad.	12,703
052 125 030500	PRO 500 GR. PROTOLİN REÇİNE	1	ad.	18,217
052 125 030600	PRO 600 GR. PROTOLİN REÇİNE	1	ad.	22,615
052 125 031000	PRO 1000 GR. PROTOLİN REÇİNE	1	ad.	32,665
052 125 031500	PRO 1500 GR. PROTOLİN REÇİNE	1	ad.	49,208
052 125 033000	PRO 3 KG PROTOLİN REÇİNE	1	ad.	98,625
052 125 030040	PRO 4 KG PROTOLİN REÇİNE	1	ad.	114,120
052 125 030020	PRO 20 KG PROTOLİN REÇİNE	1	ad.	565,363



<b>YENİLENEBİLİR ESNEK DOLGULU REÇİNELER</b>				
052 125 032000	PSİL 1000 GR. PROSİL REÇİNE	1	ad.	53,116
<b>0.6-1 kV A.G. PAPUÇSUZ REÇİNELİ KABLO BAŞLIKLARI</b>				
052 125 070001	PKB 01 (2X1,5-3X50+25)	1	ad.	13,192
052 125 070002	PKB 02 (3X70+35-3X95+50)	1	ad.	18,845
052 125 070003	PKB 03 (3X120+70-3X150+70)	1	ad.	32,735



<b>0.6-1 kV BAKIR İLETKENLER İÇİN ISI BÜZÜŞMELİ EK MUFLARI(AYNI KESİTLERDE ALÜMİNYUM MEVCUTTUR.)</b>				
052 125 020012	S1 415-S1 425 (4X1,5-4X2,5) ISI BÜZÜŞMELİ	1	ad.	15,565
052 125 020011	S1 404-S1 406 (4X4-4X6) ISI BÜZÜŞMELİ	1	ad.	15,565
052 125 020001	S1 410 (4X10) ISI BÜZÜŞMELİ	1	ad.	19,613
052 125 020002	S1 416 (4X16) ISI BÜZÜŞMELİ	1	ad.	20,730
052 125 120425	S1 425 (4X25) ISI BÜZÜŞMELİ	1	ad.	32,037
052 125 120435	S1 435 (4X35) ISI BÜZÜŞMELİ	1	ad.	34,480
052 125 120450	S1 450 (4X50) ISI BÜZÜŞMELİ	1	ad.	37,272
052 125 120470	S1 470 (4X70) ISI BÜZÜŞMELİ	1	ad.	55,280
052 125 120495	S1 495 (4X95) ISI BÜZÜŞMELİ	1	ad.	60,724
052 125 124120	S1 4120 (4X120) ISI BÜZÜŞMELİ	1	ad.	79,290
052 125 124150	S1 4150 (4X150) ISI BÜZÜŞMELİ	1	ad.	92,412
052 125 124185	S1 4185 (4X185) ISI BÜZÜŞMELİ	1	ad.	157,604
052 125 124240	S1 4240 (4X240) ISI BÜZÜŞMELİ	1	ad.	164,793
052 125 124300	S1 4300 (4X300) ISI BÜZÜŞMELİ	1	ad.	180,079
052 125 124400	S1 4400 (4X400) ISI BÜZÜŞMELİ	1	ad.	203,531
052 125 020003	S1 31610 (3X16+10) ISI BÜZÜŞMELİ	1	ad.	20,730
052 125 020004	S1 32616 (3X25+16) ISI BÜZÜŞMELİ	1	ad.	30,990
052 125 020005	S1 33516 (3X35+16) ISI BÜZÜŞMELİ	1	ad.	33,643
052 125 020006	S1 35025 (3X50+25) ISI BÜZÜŞMELİ	1	ad.	36,225
052 125 020007	S1 37035 (3X70+35) ISI BÜZÜŞMELİ	1	ad.	54,303
052 125 020008	S1 39550 (3X95+50) ISI BÜZÜŞMELİ	1	ad.	59,259
052 125 020009	S1 31207 (3X120+70) ISI BÜZÜŞMELİ	1	ad.	77,406
052 125 020027	S1 31507 (3X150+70) ISI BÜZÜŞMELİ	1	ad.	95,414
052 125 020010	S1 31859 (3X185+95) ISI BÜZÜŞMELİ	1	ad.	155,649
052 125 020028	S1 32401 (3X240+120) ISI BÜZÜŞMELİ	1	ad.	162,839
052 125 123315	S1 33001 (3X300+150) ISI BÜZÜŞMELİ	1	ad.	176,100
052 125 123418	S1 34001 (3X400+185) ISI BÜZÜŞMELİ	1	ad.	199,622

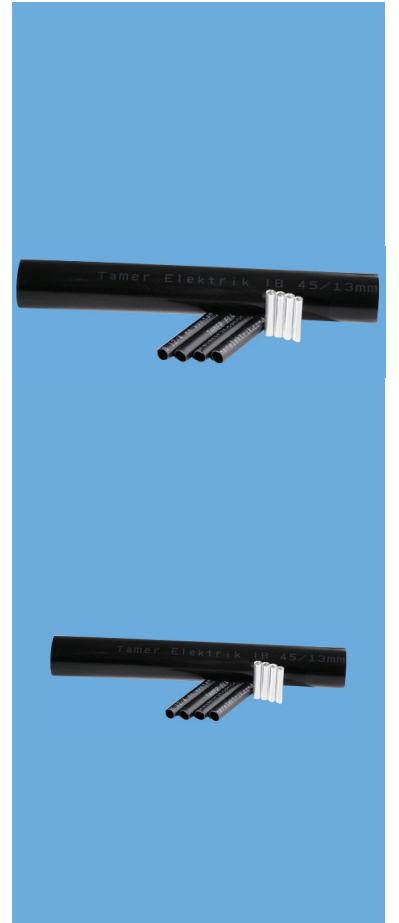



Ürün Kodu	Açıklama / Stok Cinsi	Ambalaj (Kutulu)	Ambalaj Birimi	TL
<b>0,6-1 KV NY-NYCY KABLolar İÇİN ŞEFFAF REÇİNELİ KABLO EK MUFLARI</b>				
052 125 090410	ŞE1 410 (4X10)	1	ad.	48,789
052 125 090416	ŞE1 416 (4X16)	1	ad.	48,789
052 125 090425	ŞE1 425 (4X25)	1	ad.	50,952
052 125 091610	ŞE1 31610 (3X16+10)	1	ad.	48,789
052 125 092516	ŞE1 32516 (3X25+16)	1	ad.	49,836
052 125 091012	ŞE1 1015-E1 1025 (3X1,5-10X2,5)	1	ad.	60,934
052 125 090406	ŞE1 1004-E1 1006 (10X4-10X6)	1	ad.	60,934
052 125 090435	ŞE1 435 (4X35)	1	ad.	117,889
052 125 090450	ŞE1 450 (4X50)	1	ad.	119,983
052 125 090470	ŞE1 470 (4X70)	1	ad.	122,146
052 125 090495	ŞE1 495 (4X95)	1	ad.	125,287
052 125 093516	ŞE1 33516 (3X35+16)	1	ad.	116,772
052 125 095025	ŞE1 35025 (3X50+25)	1	ad.	118,936
052 125 097035	ŞE1 37035 (3X70+35)	1	ad.	121,030
052 125 099550	ŞE1 39550 (3X95+50)	1	ad.	123,124
052 125 092412	ŞE1 2415-E1 2425 (24X1,5-24X2,5)	1	ad.	91,435



<b>T TİPİ</b>				
052 125 050410	TE1 410 (4X10)	1	ad.	132,895
052 125 050416	TE1 416 (4X16)	1	ad.	132,895
052 125 050425	TE1 425 (4X25)	1	ad.	139,596
052 125 051610	TE1 31610 (3X16+10)	1	ad.	132,895
052 125 052516	TE1 32516 (3X25+16)	1	ad.	139,596
052 125 050435	TE1 435 (4X35)	1	ad.	211,558
052 125 050450	TE1 450 (4X50)	1	ad.	213,861
052 125 050470	TE1 470 (4X70)	1	ad.	216,094
052 125 050495	TE1 495 (4X95)	1	ad.	219,305
052 125 053516	TE1 33516 (3X35+16)	1	ad.	210,441
052 125 055025	TE1 35025 (3X50+25)	1	ad.	212,674
052 125 057035	TE1 37035 (3X70+35)	1	ad.	214,978
052 125 059550	TE1 39550 (3X95+50)	1	ad.	217,141
052 125 054120	TE1 4120 (4X120)	1	ad.	382,493
052 125 054150	TE1 4150 (4X150)	1	ad.	389,472
052 125 054185	TE1 4185 (4X185)	1	ad.	413,204
052 125 054240	TE1 4240 (4X240)	1	ad.	402,036
052 125 051207	TE1 31207 (3X120+70)	1	ad.	397,848
052 125 051507	TE1 31507 (3X150+70)	1	ad.	400,640
052 125 051859	TE1 31859 (3X185+95)	1	ad.	406,224
052 125 052401	TE1 32401 (3X240+120)	1	ad.	413,204



<b>Y TİPİ</b>				
		KABLO KESİTİ	Y ÇIKIŞ KESİTİ	
052 125 061161	YE1 11615	(1X16-1X1,5)		41,739
052 125 061251	YE1 12516	(1X25-1X16)		44,322
052 125 061352	YE1 13525	(1X35-1X25)		44,322
052 125 061503	YE1 15035	(1X50-1X35)		50,952
052 125 061705	YE1 17050	(1X70-1X50)		50,952
052 125 061957	YE1 19570	(1X95-1X70)		59,817
052 125 061120	YE1 112095	(1X120-1X95)		59,817
052 125 064011	YE1 41515	(4X1,5-4X1,5)		66,448
052 125 064021	YE1 42515	(4X2,5-4X1,5)		66,448
052 125 064041	YE1 44015	(4X4-4X1,5)		66,448
052 125 064101	YE1 41015	(4X10-4X1,5)		66,448

Ürün Kodu	Açıklama / Stok Cinsi	Ambalaj (Kutulu)	Ambalaj Birimi	TL
<b>0,6-1 KV NYY-NCY KABLOLAR İÇİN DÜZ TİP ŞEFFAF REÇİNELİ KABLO EK MUFLARI</b>				
052 125 080410	VDE1 410 (4X10)	1	ad.	93,517
052 125 080416	VDE1 416 (4X16)	1	ad.	93,517
052 125 080425	VDE1 425 (4X25)	1	ad.	97,414
052 125 081610	VDE1 31610 (3X16+10)	1	ad.	93,517
052 125 082516	VDE1 32516 (3X25+16)	1	ad.	97,414
052 125 080435	VDE1 435 (4X35)	1	ad.	157,161
052 125 080450	VDE1 450 (4X50)	1	ad.	157,161
052 125 080470	VDE1 470 (4X70)	1	ad.	163,655
052 125 083516	VDE1 33516 (3X35+16)	1	ad.	157,161
052 125 085025	VDE1 35025 (3X50+25)	1	ad.	157,161
052 125 087035	VDE1 37035 (3X70+35)	1	ad.	163,655
052 125 080495	VDE1 495 (4X95)	1	ad.	200,023
052 125 084120	VDE1 4120 (4X120)	1	ad.	251,977
052 125 084150	VDE1 4150 (4X150)	1	ad.	283,149
052 125 084185	VDE1 4185 (4X185)	1	ad.	283,149
052 125 084240	VDE1 4240 (4X240)	1	ad.	283,149
052 125 089550	VDE1 39550 (3X95+50)	1	ad.	200,023
052 125 081207	VDE1 31207 (3X120+70)	1	ad.	251,977
052 125 081507	VDE1 31507 (3X150+70)	1	ad.	283,149
052 125 081859	VDE1 31859 (3X185+95)	1	ad.	283,149

<b>0,6-1 KV NYY-NCY KABLOLAR İÇİN Y BRANŞMAN VİDALI TİP ŞEFFAF REÇİNELİ KABLO EK MUFLARI</b>				
052 125 100410	VYE1 410 (4X10)	1	ad.	113,000
052 125 100416	VYE1 416 (4X16)	1	ad.	113,000
052 125 100425	VYE1 425 (4X25)	1	ad.	118,195
052 125 101610	VYE1 31610 (3X16+10)	1	ad.	113,000
052 125 102516	VYE1 32516 (3X25+16)	1	ad.	118,195
052 125 100435	VYE1 435 (4X35)	1	ad.	172,747
052 125 100450	VYE1 450 (4X50)	1	ad.	172,747
052 125 100470	VYE1 470 (4X70)	1	ad.	175,344
052 125 103516	VYE1 33516 (3X35+16)	1	ad.	172,747
052 125 105025	VYE1 35025 (3X50+25)	1	ad.	172,747
052 125 107035	VYE1 37035 (3X70+35)	1	ad.	175,344
052 125 100495	VYE1 495 (4X95)	1	ad.	245,482
052 125 104120	VYE1 4120 (4X120)	1	ad.	250,678
052 125 109550	VYE1 39550 (3X95+50)	1	ad.	245,482
052 125 101207	VYE1 31207 (3X120+70)	1	ad.	250,678
052 125 104150	VYE1 4150 (4X150)	1	ad.	423,424
052 125 104185	VYE1 4185 (4X185)	1	ad.	423,424
052 125 104240	VYE1 4240 (4X240)	1	ad.	427,321
052 125 101507	VYE1 31507 (3X150+70)	1	ad.	423,424
052 125 101859	VYE1 31859 (3X185+95)	1	ad.	423,424
052 125 102401	VYE1 32401 (3X240+120)	1	ad.	427,321

<b>FERMUARLI ISI BÜZÜŞMELİ KABLO EK MUFLARI</b>				
052 125 144105	FS1 4105 (4X1,5) FERMUARLI ISI BÜZÜŞMELİ	1	ad.	59,398
052 125 144205	FS1 4205 (4X2,5) FERMUARLI ISI BÜZÜŞMELİ	1	ad.	59,398
052 125 140404	FS1 404 (4X4) FERMUARLI ISI BÜZÜŞMELİ	1	ad.	59,398
052 125 140406	FS1 406 (4X6) FERMUARLI ISI BÜZÜŞMELİ	1	ad.	59,398
052 125 140410	FS1 410 (4X10) FERMUARLI ISI BÜZÜŞMELİ	1	ad.	63,726
052 125 140416	FS1 416 (4X16) FERMUARLI ISI BÜZÜŞMELİ	1	ad.	67,914
052 125 140425	FS1 425 (4X25) FERMUARLI ISI BÜZÜŞMELİ	1	ad.	72,241
052 125 140435	FS1 435 (4X35) FERMUARLI ISI BÜZÜŞMELİ	1	ad.	73,288
052 125 140450	FS1 450 (4X50) FERMUARLI ISI BÜZÜŞMELİ	1	ad.	75,452
052 125 140470	FS1 470 (4X70) FERMUARLI ISI BÜZÜŞMELİ	1	ad.	96,670
052 125 140495	FS1 495 (4X95) FERMUARLI ISI BÜZÜŞMELİ	1	ad.	99,811
052 125 144120	FS1 4120 (4X120) FERMUARLI ISI BÜZÜŞMELİ	1	ad.	118,866
052 125 144150	FS1 4150 (4X150) FERMUARLI ISI BÜZÜŞMELİ	1	ad.	123,124
052 125 144185	FS1 4185 (4X185) FERMUARLI ISI BÜZÜŞMELİ	1	ad.	146,506
052 125 144240	FS1 4240 (4X240) FERMUARLI ISI BÜZÜŞMELİ	1	ad.	161,373
052 125 144300	FS1 4300 (4X300) FERMUARLI ISI BÜZÜŞMELİ	1	ad.	195,295
052 125 144400	FS1 4400 (4X400) FERMUARLI ISI BÜZÜŞMELİ	1	ad.	216,583
052 125 141610	FS1 31610 (3X16+10) FERMUARLI ISI BÜZÜŞMELİ	1	ad.	67,914
052 125 142516	FS1 32516 (3X25+16) FERMUARLI ISI BÜZÜŞMELİ	1	ad.	71,194
052 125 143516	FS1 33516 (3X35+16) FERMUARLI ISI BÜZÜŞMELİ	1	ad.	72,241
052 125 145025	FS1 35025 (3X50+25) FERMUARLI ISI BÜZÜŞMELİ	1	ad.	74,335
052 125 147035	FS1 37035 (3X70+35) FERMUARLI ISI BÜZÜŞMELİ	1	ad.	95,484
052 125 149550	FS1 39550 (3X95+50) FERMUARLI ISI BÜZÜŞMELİ	1	ad.	97,717
052 125 141207	FS1 31207 (3X120+70) FERMUARLI ISI BÜZÜŞMELİ	1	ad.	116,772
052 125 141507	FS1 31507 (3X150+70) FERMUARLI ISI BÜZÜŞMELİ	1	ad.	121,030
052 125 141859	FS1 31859 (3X185+95) FERMUARLI ISI BÜZÜŞMELİ	1	ad.	144,412
052 125 142401	FS1 32401 (3X240+120) FERMUARLI ISI BÜZÜŞMELİ	1	ad.	159,279
052 125 143001	FS1 33001 (3X300+150) FERMUARLI ISI BÜZÜŞMELİ	1	ad.	191,107
052 125 143401	FS1 34001 (3X400+185) FERMUARLI ISI BÜZÜŞMELİ	1	ad.	212,325



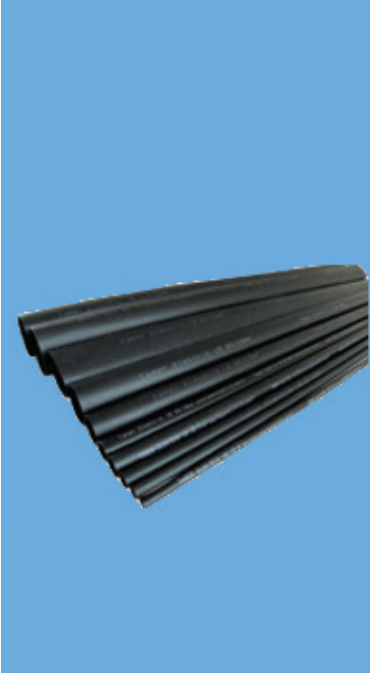

Ürün Kodu	Açıklama / Stok Cinsi	Ambalaj (Kutulu)	Ambalaj Birimi	TL
<b>ISI BÜZÜŞMELİ - REÇİNELİ YALITIM BORULARI</b>				
	DARALMA ÖNCESİ(MM) / DARALMA SONRASI(MM) / UZUNLUK (MT)			
052 125 300903	TIB-9/3 9 / 3 / 1,2 REÇİNELİ YALITIM BORULARI	1	mt.	5,584
052 125 301204	TIB-12/4 12 / 4 / 1,2 REÇİNELİ YALITIM BORULARI	1	mt.	13,541
052 125 301605	TIB-16/5 16 / 5 / 1,2 REÇİNELİ YALITIM BORULARI	1	mt.	16,542
052 125 302206	TIB-22/6 22 / 6 / 1,2 REÇİNELİ YALITIM BORULARI	1	mt.	17,101
052 125 302508	TIB-25/8 25 / 8 / 1,2 REÇİNELİ YALITIM BORULARI	1	mt.	19,893
052 125 303310	TIB-33/10 33 / 10 / 1,15 REÇİNELİ YALITIM BORULARI	1	mt.	20,660
052 125 304012	TIB-40/12 40 / 12 / 1,15 REÇİNELİ YALITIM BORULARI	1	mt.	21,707
052 125 304515	TIB-45/15 45 / 15 / 1,15 REÇİNELİ YALITIM BORULARI	1	mt.	27,919
052 125 305418	TIB-54/18 54 / 18 / 1,15 REÇİNELİ YALITIM BORULARI	1	mt.	28,338
052 125 306522	TIB-65/22 65 / 22 / 1,15 REÇİNELİ YALITIM BORULARI	1	mt.	29,036
052 125 307522	TIB-75/22 75 / 22 / 1,15 REÇİNELİ YALITIM BORULARI	1	mt.	32,945
052 125 308030	TIB-80/30 80 / 30 / 1,15 REÇİNELİ YALITIM BORULARI	1	mt.	41,600
052 125 309030	TIB-90/30 90 / 30 / 1,15 REÇİNELİ YALITIM BORULARI	1	mt.	42,367
052 125 310533	TIB-105/33 105 / 33 / 1,15 REÇİNELİ YALITIM BORULARI	1	mt.	48,161
052 125 311534	TIB-115/34 115 / 34 / 1,50 REÇİNELİ YALITIM BORULARI	1	mt.	53,046
052 125 312540	TIB-125/40 125 / 40 / 1,15 REÇİNELİ YALITIM BORULARI	1	mt.	56,187
052 125 314040	TIB-140/40 140 / 40 / 1,40 REÇİNELİ YALITIM BORULARI	1	mt.	64,912
052 125 315050	TIB-150/50 150 / 50 / 1,40 REÇİNELİ YALITIM BORULARI	1	mt.	127,032
052 125 317058	TIB-170/58 170 / 58 / 1,15 REÇİNELİ YALITIM BORULARI	1	mt.	138,898



<b>BARA İZOLASYON BORULARI</b>				
	DARALMA ÖNCESİ(MM) / DARALMA SONRASI(MM) / UZUNLUK (MT)			
052 125 403310	TAIB-33/10 33 / 10 / 1,15-25 MT RULO BARA İZOL. BORULARI	1	mt.	57,793
052 125 403812	TAIB-38/12 38 / 12 / 1,15-25 MT RULO BARA İZOL. BORULARI	1	mt.	61,003
052 125 404517	TAIB-45/17 45 / 17 / 1,15-25 MT RULO BARA İZOL. BORULARI	1	mt.	71,333
052 125 405418	TAIB-54/18 54 / 18 / 1,15-25 MT RULO BARA İZOL. BORULARI	1	mt.	73,986
052 125 406022	TAIB-60/22 60 / 22 / 1,15-25 MT RULO BARA İZOL. BORULARI	1	mt.	76,778
052 125 406522	TAIB-65/22 65 / 22 / 1,15-25 MT RULO BARA İZOL. BORULARI	1	mt.	76,778
052 125 407522	TAIB-75/22 75 / 22 / 1,15-25 MT RULO BARA İZOL. BORULARI	1	mt.	76,778
052 125 409030	TAIB-90/30 90 / 30 / 1,15-25 MT RULO BARA İZOL. BORULARI	1	mt.	88,295
052 125 411040	TAIB-110/40 110 / 40 / 1,15 BARA İZOLASYON BORULARI	1	mt.	102,603
052 125 412540	TAIB-125/40 125 / 40 / 1,15 BARA İZOLASYON BORULARI	1	mt.	102,603
052 125 414040	TAIB-140/40 140 / 40 / 1,15 BARA İZOLASYON BORULARI	1	mt.	102,603
052 125 416050	TAIB-160/50 160 / 50 / 1,15 BARA İZOLASYON BORULARI	1	mt.	162,769

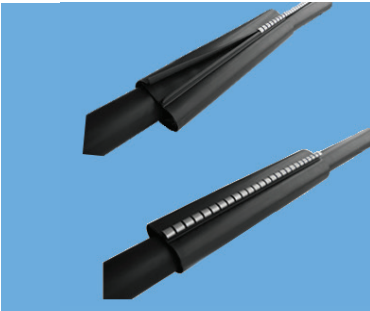

<b>FERMUARLI TAMİR BORULARI</b>				
	DARALMA ÖNCESİ(MM) / DARALMA SONRASI(MM) / UZUNLUK (MT)			
052 125 503012	TFB-30/12 30 / 12 / 1 FERMUARLI TAMİR BORULARI	1	mt.	52,767 EUR.
052 125 503812	TFB-38/12 38 / 12 / 1 FERMUARLI TAMİR BORULARI	1	mt.	52,767 EUR.
052 125 505018	TFB-50/18 50 / 18 / 1 FERMUARLI TAMİR BORULARI	1	mt.	56,467 EUR.
052 125 506522	TFB-65/22 65 / 22 / 1 FERMUARLI TAMİR BORULARI	1	mt.	62,888 EUR.
052 125 508530	TFB-85/30 85 / 30 / 1 FERMUARLI TAMİR BORULARI	1	mt.	67,704 EUR.
052 125 510045	TFB-100/45 100 / 45 / 1 FERMUARLI TAMİR BORULARI	1	mt.	69,309 EUR.

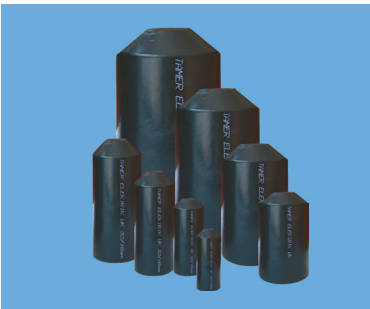

<b>UÇ KORUYUCULARI</b>				
	DARALMA ÖNCESİ(MM) / DARALMA SONRASI(MM) / UZUNLUK (MT)			
052 125 601105	UK-11/5 11 / 5,5 / 22 UÇ KORUYUCU	1	ad.	5,375
052 125 601607	UK-16/7 16 / 7,5 / 75 UÇ KORUYUCU	1	ad.	6,701
052 125 602510	UK-25/10 25 / 10,5 / 80 UÇ KORUYUCU	1	ad.	7,329
052 125 603216	UK-32/16 32 / 16,5 / 90 UÇ KORUYUCU	1	ad.	8,376
052 125 605026	UK-50/26 50 / 26 / 115 UÇ KORUYUCU	1	ad.	10,330
052 125 607037	UK-70/37 70 / 37 / 120 UÇ KORUYUCU	1	ad.	13,192
052 125 610046	UK-100/46 100 / 46 / 140 UÇ KORUYUCU	1	ad.	15,565
052 125 612057	UK-120/57 120 / 57 / 155 UÇ KORUYUCU	1	ad.	18,497



*Anahtar Fiyat Listesi İin Listeyi 180° eviriniz...*



**Mutluluęun  
anahtarları...**



**2016  
FİYAT LİSTESİ**



**Mutlusan®**  
electric



Genel Fiyat Listesi İçin Katalogu 180° Çeviriniz....

